



4

3

2

1

THIS DRAWING IS UNPUBLISHED. RELEASED FOR PUBLICATION  
 © COPYRIGHT 2010 BY TYCO ELECTRONICS CORPORATION. ALL RIGHTS RESERVED.

LOC	DIST	REVISIONS			
P	LTR	DESCRIPTION	DATE	DWN	APVD
SEE SHEET 1.					

**MODULAR JACK WITHOUT LED**

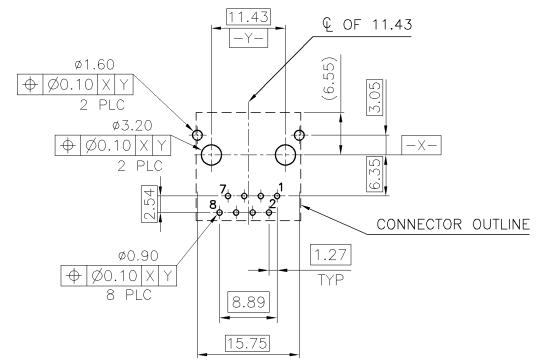
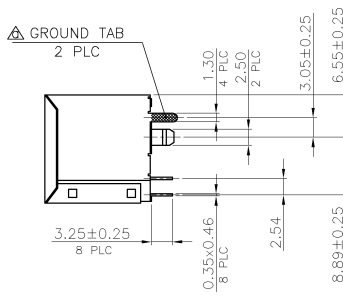
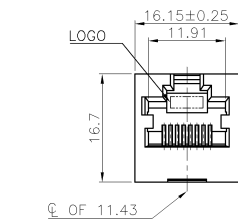

RECOMMENDED PCB LAYOUT  
 TOLERANCE: ±0.05 (TOP VIEW)

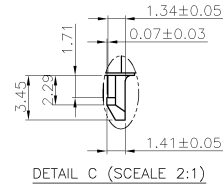
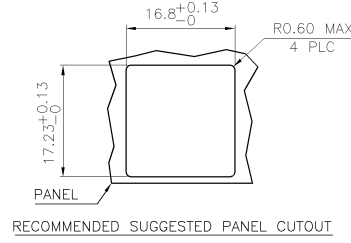
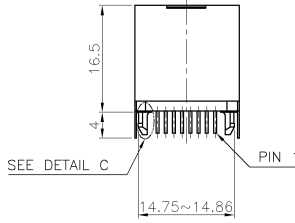

- NOTE:
- MATERIAL:  
 HOUSING: PA46, WITH 30% GF, UL94 V-0, BLACK COLOR.  
 CONTACTS: PHOSPHOR BRONZE.  
 SHELL: BRASS.
  - FINISH:  
 CONTACTS: (SEE TABLE) GOLD PLATED ON CONTACT AREA,  
 GOLD FLASH ON SOLDER TAIL,  
 WITH ENTIRE CONTACT UNDERPLATED  
 1.27µm [50µ"] MIN. NICKEL.  
 SHELL: 0.508µm [20µ"] MIN. NICKEL PLATED.  
 POST DIPPED WITH TIN ON PCB GROUND TABS.
  - WAVE SOLDER CAPABLE TO 265°C PER TE SPEC 109-202, CONDITION B.
  - OBsolete PARTS: OBsolete CIS STREAMLINING PER D.RENAUD/D.SINISI

MIN. GOLD THICKNESS	PART NUMBER
1.27µm [50µ"]	3-1734577-5
1.27µm [50µ"]	3-1734577-4
0.762µm [30µ"]	3-1734577-3
0.381µm [15µ"]	3-1734577-2
0.152µm [6µ"]	3-1734577-1

THIS DRAWING IS A CONTROLLED DOCUMENT.		DWN		 <b>TE Connectivity</b> MODULAR JACK CONNECTOR RJ45, 8P8C, VERTICAL, DIP TYPE	
DIMENSIONS:		CHK			
TOLERANCES UNLESS OTHERWISE SPECIFIED:		APVD			
mm		PRODUCT SPEC			
0 PLC ± - 1 PLC ± 0.3 2 PLC ± 0.2 3 PLC ± 0.15 4 PLC ± - ANGLES ± °		APPLICATION SPEC		NAME	
MATERIAL		FINISH		SIZE CAGE CODE DRAWING NO	
				RESTRICTED TO	
		WEIGHT 6.7 GRAMS		A3 00779 C-1734577	
		CUSTOMER DRAWING		SCALE SHEET 2 OF 3 REV C4	

4

3

2

1

THIS DRAWING IS UNPUBLISHED. RELEASED FOR PUBLICATION  
 © COPYRIGHT 2010 BY TYCO ELECTRONICS CORPORATION. ALL RIGHTS RESERVED.

LOC	DIST	REVISIONS			
P	LTR	DESCRIPTION	DATE	DWN	APVD
		SEE SHEET 1.			

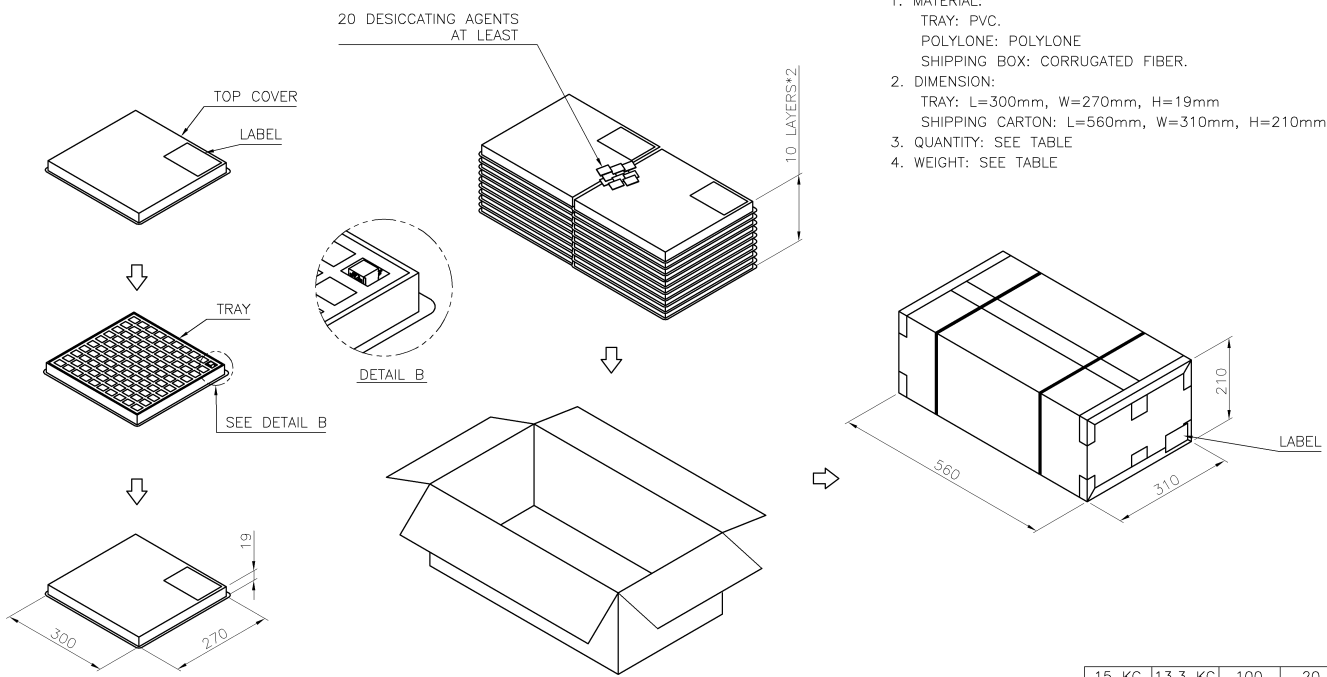

- NOTES:
- MATERIAL:  
 TRAY: PVC.  
 POLYLONE: POLYLONE  
 SHIPPING BOX: CORRUGATED FIBER.
  - DIMENSION:  
 TRAY: L=300mm, W=270mm, H=19mm  
 SHIPPING CARTON: L=560mm, W=310mm, H=210mm
  - QUANTITY: SEE TABLE
  - WEIGHT: SEE TABLE

15 KG	13.3 KG	100	20	2000
GROSS WEIGHT	NET WEIGHT	PCS/TRAY	TRAY/BOX	PCS/BOX

THIS DRAWING IS A CONTROLLED DOCUMENT.

DIMENSIONS: mm	TOLERANCES UNLESS OTHERWISE SPECIFIED: 0 PLC ± 1 PLC ±0.3 2 PLC ±0.2 3 PLC ±0.15 4 PLC ± ANGLES ±°	DWN CHK APVD PRODUCT SPEC APPLICATION SPEC WEIGHT	TE Connectivity MODULAR JACK CONNECTOR RJ45, 8P8C, VERTICAL, DIP TYPE
MATERIAL	FINISH	SIZE A3	CAGE CODE 00779
		DRAWING NO. C-1734577	RESTRICTED TO
		CUSTOMER DRAWING	SCALE SHEET 3 of 3 REV C4