

COPYRIGHT 2000 BY TICO ELECTRONICS CORPORATION.		REVISED		DATE	DMN	APPD
USER DIRECTION OF FEED		DESCRIPTION		03NOV2011	T.Z	S.Y
引き出し方向		P	LR	REVISED	ECR-11-022332	
		A1				

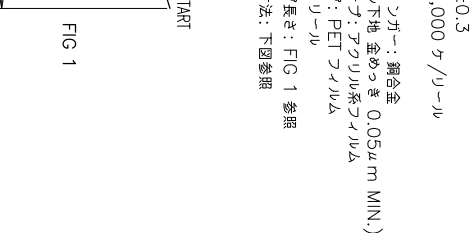

シールドフィンガー 1715  
SHIELD FINGER 1715  
旧型番: 3400196 SCALE 10:1  
OLD CAT. NO. 3400196 (0.82)

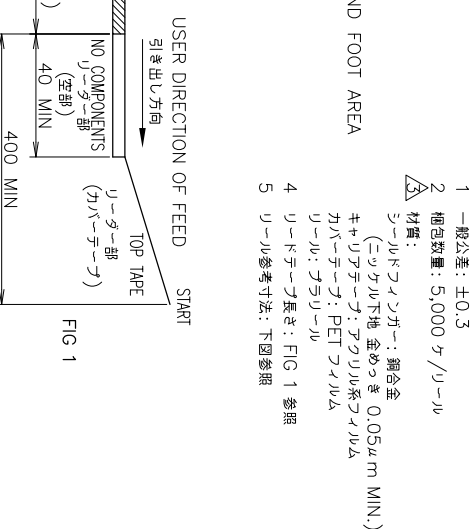
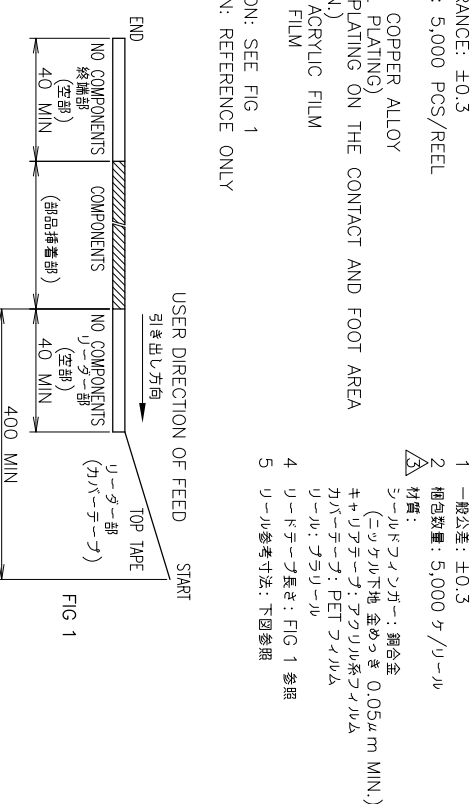
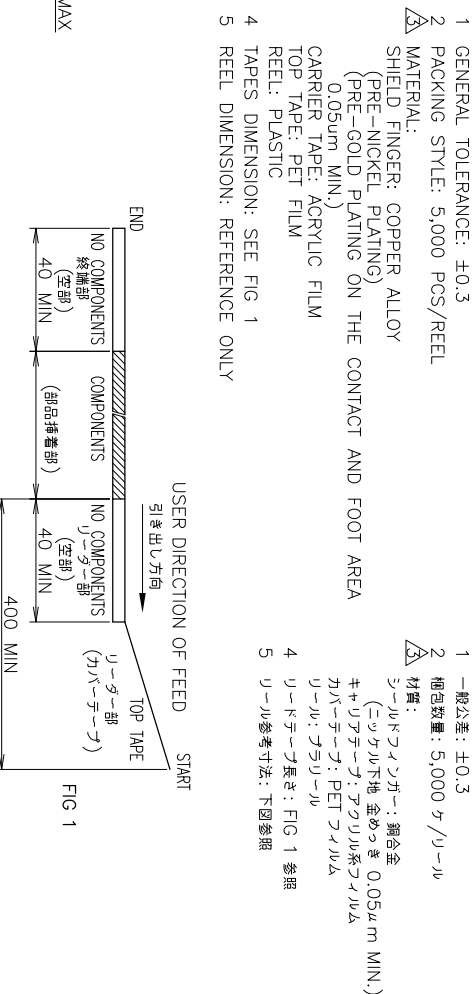
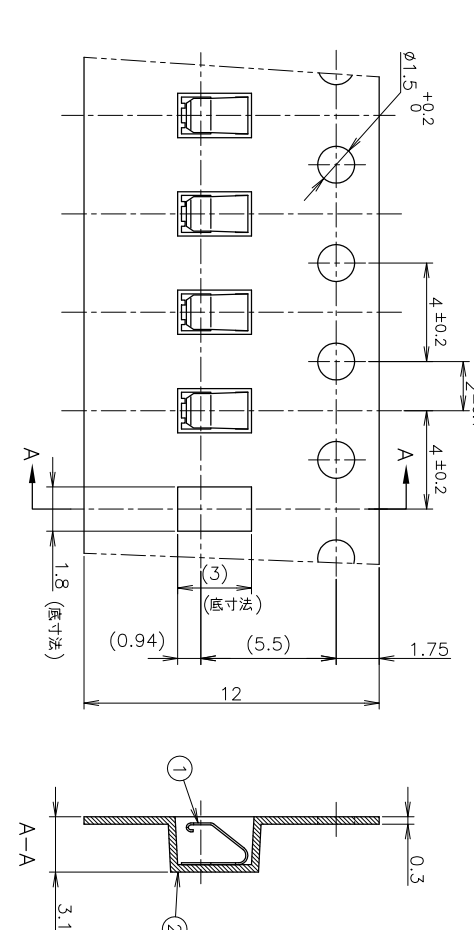
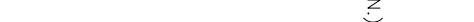
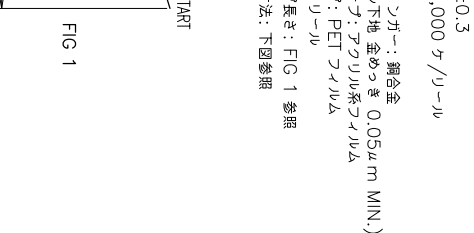
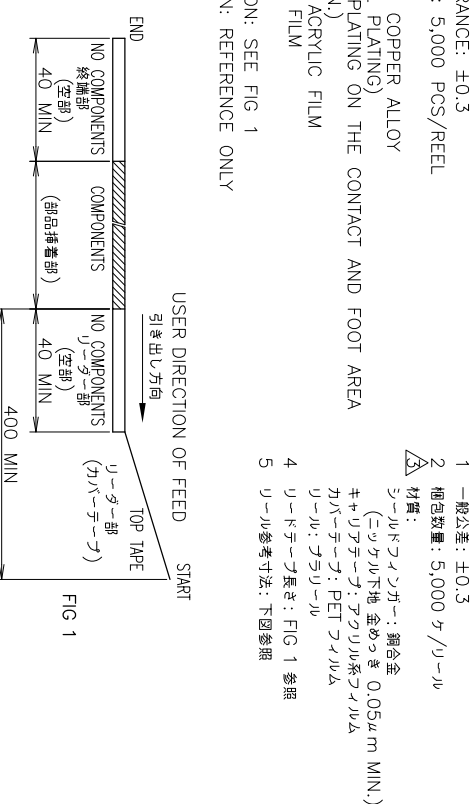
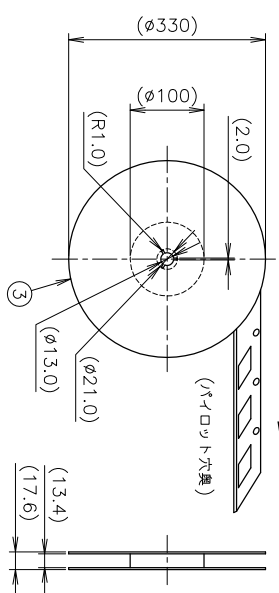
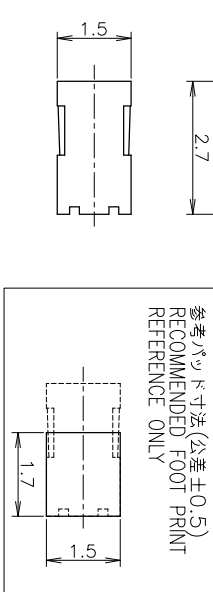
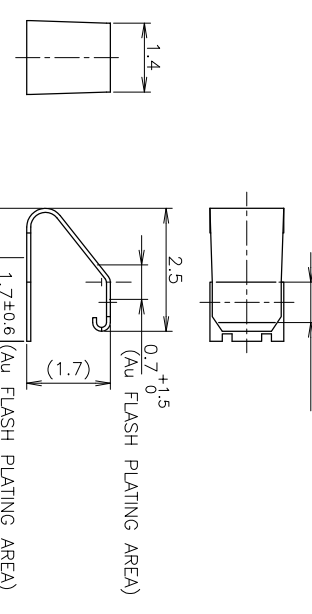

1447360-9	3100069	旧型番: 3400196	旧型番: 3150008	1
1447360-9	3100069	旧型番: 3400196	旧型番: 3150038	5000 (部品装着部)
①	1715	シールドフィンガー	シールドフィンガー (旧型番: 3400196)	5000
②	1715	シールドフィンガー	シールドフィンガー (旧型番: 3400196)	5000
③	1715	シールドフィンガー	シールドフィンガー (旧型番: 3400196)	5000

THIS DRAWING IS A CONTROLLED DOCUMENT.		THIS DRAWING IS A CONTROLLED DOCUMENT.	
PACKAGING CAT. NO.	OLD PACKAGING CAT. NO.	DESIGNATION	CAT. NO.
1447360-9	3100069	シールドフィンガー	1447360-9
DIM: K.TAMURA 14SEF2000		Tyco Electronics AMP K.K.	
CHK: K.KODAIRA 25SEF2000		Kawasaki, Japan	
APD: K.KODAIRA 25SEF2000		PACKAGING OF SHIELD FINGER 1715	
PRODUCT SPEC		ON CONTINUOUS TAPES	
製品仕様		シールドフィンガー 1715用 テーピング用	
APPLICATION SPEC		取得番号後	
FINISH		RESTRICTED	
MATERIAL		SCALE 5:1	
材料		SHEET 1 OF 1	
③		REV A1	