

THIS DRAWING IS UNPUBLISHED. RELEASED FOR PUBLICATION  
 COPYRIGHT BY ALL RIGHTS RESERVED.

LOC		DIST		REVISIONS			
F	LTR	DESCRIPTION	DATE	OWN	APVD		
P		REVISED PER ECO-11-005139	19MAR11	RK	HMR		

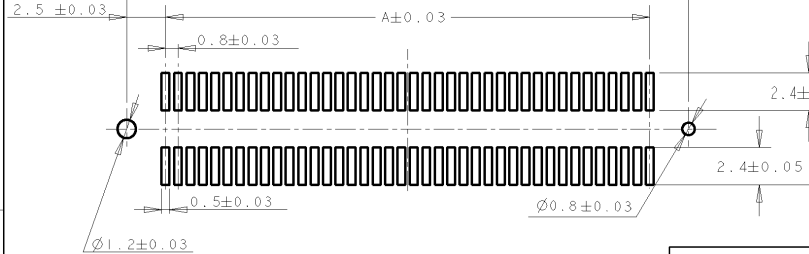
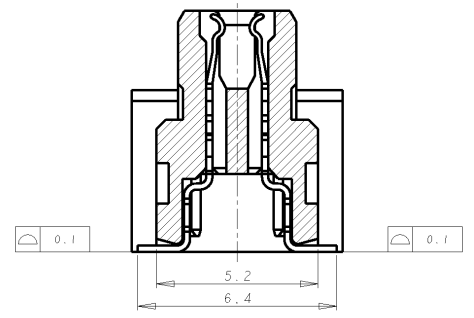
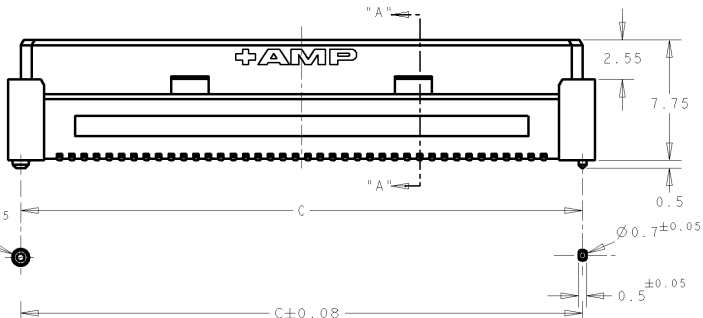
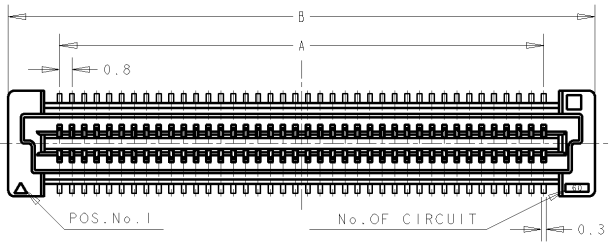

- NOTES:
- △ MATERIAL: HOUSING: L.C.P. (HIGH TEMP. THERMOPLASTIC) UL 94V-0, NATURAL. CONTACT: BERYLLIUM COPPER.
  - △ FINISH: CONTACT AREA: 0.0002 MIN GOLD ON 0.0013 MIN ALL OVER NICKEL. SOLDERING AREA: 0.002 MIN MATTE-TIN
  - 3. POSITION SERIES: SEE TABLE. (SHEET 2)
  - 4. CONN STACK HEIGHT COMBINE OF PLUG "Y" H VS REC "X" H. STACK HEIGHT = Y + X - 5

RECOMMENDED P.C. BOARD LAYOUT

DIMENSIONS: mm		TOLERANCES UNLESS OTHERWISE SPECIFIED:		OWN: FLORENCE TAN 14SIP04				
0 PLC ± 1 PLC ±0.30 2 PLC ±0.25 3 PLC ±0.20 4 PLC ± ANGLES ±°		MATERIAL △ FINISH △		CRE: ERIC TNG APVD: SEIFONG PRODUCT SPEC: 108-5390 APPLICATION SPEC: 114-5254 WEIGHT: -				NAME: RCEPTACLE ASSEMBLY 9H TYPE FOR FH 0.8mm PITCH B-T-B CONNECTOR SIZE: A3 CAGE CODE: 00779 DRAWING NO: C-5179009
CUSTOMER DRAWING				SCALE: 4:1		SHEET 1 OF 2		REV P

AMP 1470-19 REV 09MAY94  
 P1: ENGINEER DRAWING

THIS DRAWING IS UNPUBLISHED.		RELEASED FOR PUBLICATION		LOC		DIST		REVISIONS									
COPYRIGHT		BY		ALL RIGHTS RESERVED.		DY -		F LTR		DESCRIPTION		DATE		DWN		APVD	
								- SEE SHEET 1 OF 2									

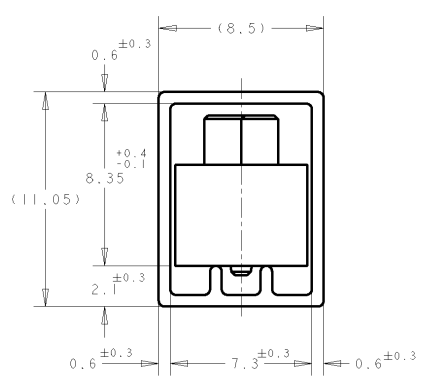
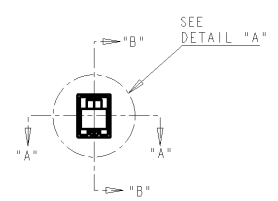
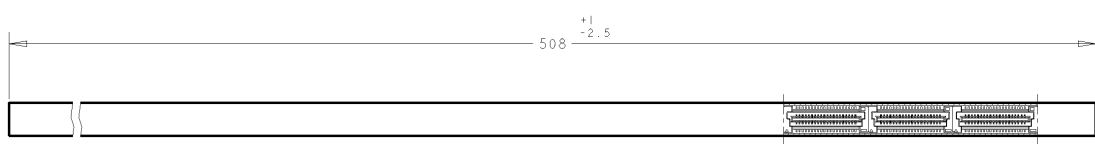

DETAIL "A"  
(SCALE 5-1)

84.20	85.80	79.20	200	6-	-0
76.20	77.80	71.20	180	5-	-9
68.20	69.80	63.20	160	5-	-8
60.20	61.80	55.20	140	5-	-6
52.20	53.80	47.20	120	5-	-5
44.20	45.80	39.20	100	5-	-4
36.20	37.80	31.20	80	5-	-3
28.20	29.80	23.20	60	5-	-2
20.20	21.80	15.20	40	5-	-1
C	B	A	POS.	PART No.	

DIMENSIONS: mm		TOLERANCES UNLESS OTHERWISE SPECIFIED:		DWN FLORENCE TAN 14SLP04		CHK ERIC TING		TE Connectivity NAME RECEPTACLE ASSEMBLY 9H TYPE FOR FH 0.8mm PITCH B-T-B CONNECTOR					
		0 PLC ± 1 PLC ±0.30 2 PLC ±0.25 3 PLC ±0.20 4 PLC ± ANGLES ±°		APVD SEIFONG PRODUCT SPEC 108-5390 APPLICATION SPEC 114-5254 WEIGHT -		SIZE A3						CAGE CODE 00779	
MATERIAL 		FINISH 		CUSTOMER DRAWING				SCALE 4:1		SHEET 2 OF 2		REV P	

AMP 14TD-19 REV 09M194