

8	7	6	5	4	3	2	1
DATE APPROVED BY: [Signature]	DESIGNED BY: [Signature]						
BY: [Signature]	DATE: [Date]						

REVISIONS		DATE	BY	APP
1	INITIALS			
2	DESCRIPTION			
3	REF: PFA0-0340-04			
4				

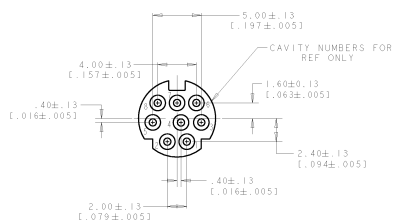

- △ RECEPTACLE CONTACTS: COPPER ALLOY.
- RECEPTACLE SHIELD: COPPER ALLOY.
- HOUSING: THERMOPLASTIC, BLACK, 94V-0 RATED.
- △ PLATING: RECEPTACLE CONTACTS - GOLD FLASH PLATED ON MATING END, MATTE-TIN PLATED .0030 MIN (.000120 MINI THICK ON SOLDER TAIL ALL OVER .0013 MIN (.000050 MINI THICK NICKEL).
- △ PLATING: SHIELD: PRE-TIN PLATED
- 4. RECEPTACLE ASSEMBLY MATES WITH 8 PIN 9.00 ± .10 [±.354 ± .004]
- △ DATUMS AND BASIC DIMENSION SUPPLIED BY CUSTOMER.

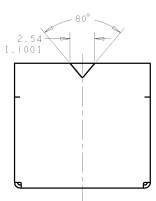
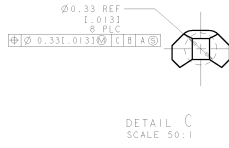
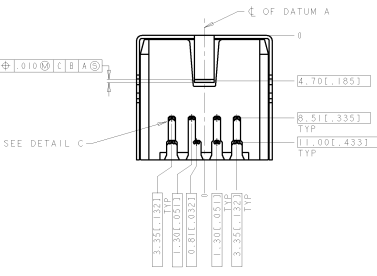
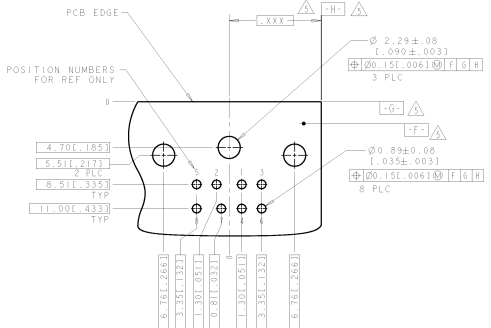
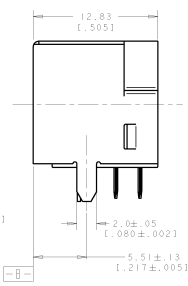
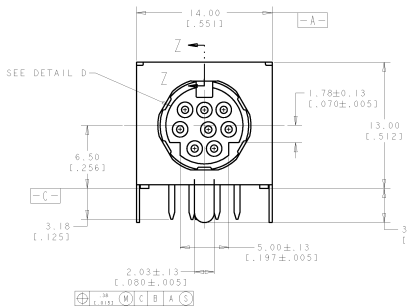

MATERIALS AND FINISHES TO BE USED UNLESS OTHERWISE SPECIFIED IN THIS DRAWING		REV: 05/20/05	P/N: ST49268-1 AS SHOWN	
SYMBOL	DESCRIPTION	SYMBOL	DESCRIPTION	SYMBOL
△	PLATING	△	RECEPTACLE CONTACTS	△
△	SHIELD	△	RECEPTACLE SHIELD	△
△	HOUSING	△	HOUSING	△

UNIT: mm (INCHES)	STANDARD: MIL-STD-883C	DATE: 05/20/05	REV: 05/20/05
SYMBOL	DESCRIPTION	SYMBOL	DESCRIPTION
△	PLATING	△	RECEPTACLE CONTACTS
△	SHIELD	△	RECEPTACLE SHIELD
△	HOUSING	△	HOUSING

DATE: 05/20/05	REV: 05/20/05	SYMBOL: △	DESCRIPTION: RECEPTACLE ASSY, 8 POS. RIGHT ANGLE, MINIATURE CIRCULAR DIN
DATE: 05/20/05	REV: 05/20/05	SYMBOL: △	DESCRIPTION: RECEPTACLE ASSY, 8 POS. RIGHT ANGLE, MINIATURE CIRCULAR DIN
DATE: 05/20/05	REV: 05/20/05	SYMBOL: △	DESCRIPTION: RECEPTACLE ASSY, 8 POS. RIGHT ANGLE, MINIATURE CIRCULAR DIN