

NUMBER C-1734146
METRIC
3RD ANGLE PROJECTION

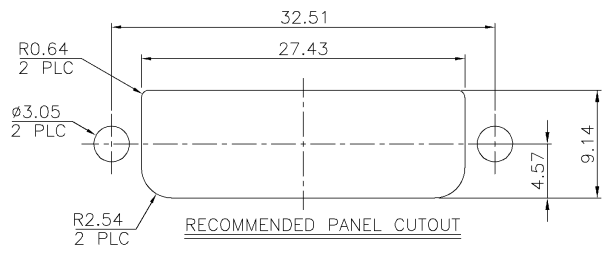

- NOTES:
- MATERIAL:
HOUSING: THERMOPLASTIC, UL 94V-0 RATED WHITE COLOR.
CONTACT: PHOSPHOR BRONZE, THICKNESS=0.3mm.
SHELL: STEEL, THICKNESS=0.5mm.
HOOK: BRASS, THICKNESS=0.5mm.
NUT: BRASS, THICKNESS=4.0mm.
 - FINISH:
CONTACT: GOLD PLATED (SEE TABLE) ON CONTACT AREA. 100µ" MIN. BRIGHT TIN PLATED ON SOLDERTAILS 50µ" MIN. NICKEL UNDERPLATED OVERALL
SHIELD: 50µ" MIN. NICKEL UNDERPLATED OVERALL
HOOK: 100µ" MIN. BRIGHT TIN PLATED OVER 30µ" MIN. NICKEL UNDERPLATED.
NUT: BRASS, NICKEL PLATED.
 - #4-40 UNC SCREW, SCREW HEAD LENGTH: 6.0±0.5mm.
 - WAVE SOLDER CAPABLE TO 245°C PER TE Connectivity SPEC 109-202, CONDITION A.

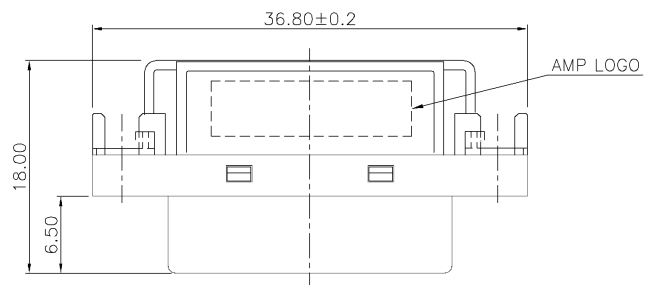
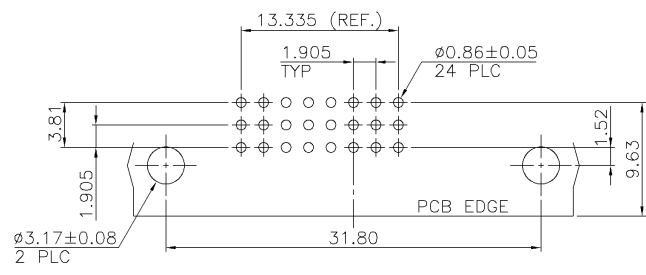
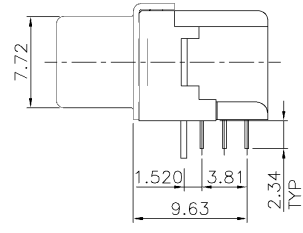
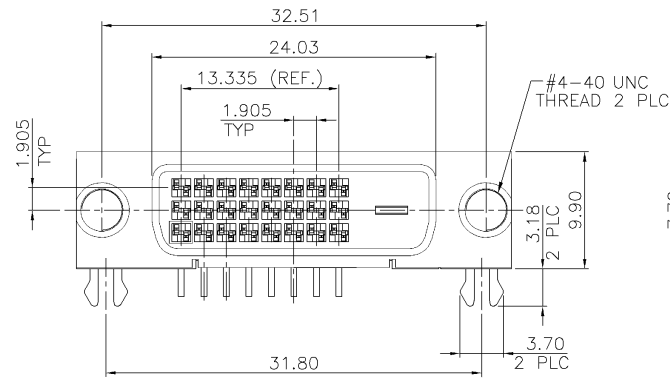

W/	30u"	1-1734146-3
W/	10u"	1-1734146-2
W/	GOLD FLASH	1-1734146-1
W/O	30u"	1734146-3
W/O	10u"	1734146-2
W/O	GOLD FLASH	1734146-1
SCREW	GOLD PLATED	PART NUMBER

TOLERANCES UNLESS OTHERWISE SPECIFIED: 0 PLC ± 0.50 1 PLC ± 0.35 2 PLC ± 0.25 3 PLC ± 0.15 ANGLES ± 3°	DWN O. HU 08-JAN-2007	TE Connectivity
MATERIAL	CHK S. HOU 08-JAN-2007	NAME
SEE NOTE	APVD W.J. KE 08-JAN-2007	DVI-D ATX RCPT. CONN., R/A, WITH BOARDLOCK
FINISH	PRODUCT SPEC 108-1941	LOC DW
SEE NOTE	APPLICATION SPEC	SCALE
	WEIGHT	SIZE A ₃
		DRAWING NO C-1734146
		REV A2
		SHEET 1 OF 2

A2	REVISED PER ECO-11-005301	RK HMR	11APR11
LTR	REVISION RECORD	DWN CHK	DATE

PRINT DIST
DW

8 7 6 5 4 3 2 1 CUSTOMER DRAWING

NUMBER C-1734146
 3RD ANGLE PROJECTION
 METRIC

PRINT DIST DW
 DIMENSIONS IN MILLIMETERS. DO NOT SCALE PRINT.

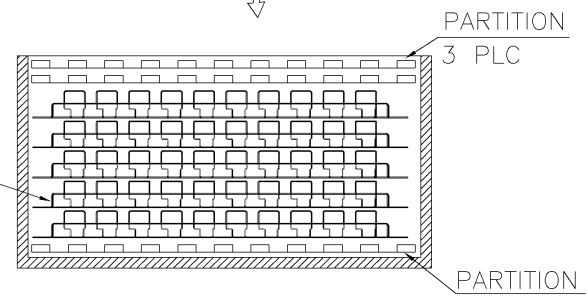
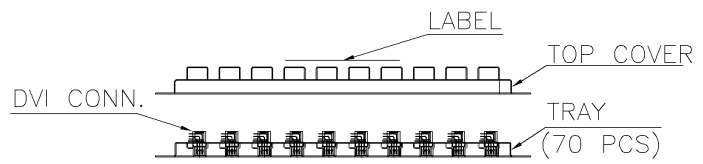

5 TRAY PER CARTON

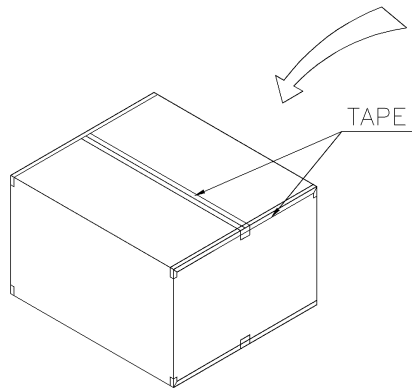

3.55	2.63	340X278X146	340X275X19.6	350
G.W./CARTON	N.W./CARTON	CARTON SIZE	TRAY SIZE	QUANTITY

TOLERANCES UNLESS OTHERWISE SPECIFIED:		DWN	O. HU	STE TE Connectivity
0 PLC ±		CHK	08-JAN-2007	
1 PLC ±		S. HOU		NAME
2 PLC ±		08-JAN-2007		
3 PLC ±		W.J. KE		DVI-D ATX RCPT. CONN., R/A, WITH BOARDLOCK
ANGLES ±		08-JAN-2007		
MATERIAL	SEE NOTE	APVD	PRODUCT SPEC	LOC SIZE DRAWING NO DW A ₃ C-1734146
FINISH	SEE NOTE	APPLICATION SPEC	WEIGHT	
LTR	REVISION RECORD	SEE SHEET 1.	DWN/CHK DATE	SCALE
				SHEET

LTR	REVISION RECORD	SEE SHEET 1.	DWN/CHK DATE

CUSTOMER DRAWING 1