

DATA SHEET

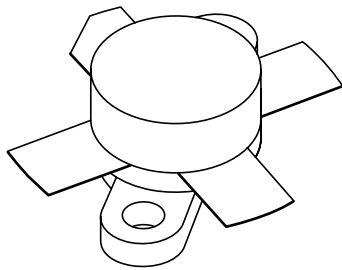

BLF246

VHF power MOS transistor

Product specification
Supersedes data of 1996 Oct 21

2003 Aug 05

VHF power MOS transistor

BLF246

FEATURES

- High power gain
- Low noise figure
- Easy power control
- Good thermal stability
- Withstands full load mismatch.

APPLICATIONS

- Large signal amplifier applications in the VHF frequency range.

DESCRIPTION

Silicon N-channel enhancement mode vertical D-MOS transistor encapsulated in a 4-lead, SOT121B flange package with a ceramic cap. All leads are isolated from the flange. A marking code, showing gate-source voltage (V_{GS}) information is provided for matched pair applications. Refer to the "General" section of the handbook for further information.

CAUTION
This product is supplied in anti-static packing to prevent damage caused by electrostatic discharge during transport and handling. For further information, refer to Philips specs.: SNW-EQ-608, SNW-FQ-302A, and SNW-FQ-302B.

PINNING - SOT121B

PIN	DESCRIPTION
1	drain
2	source
3	gate
4	source

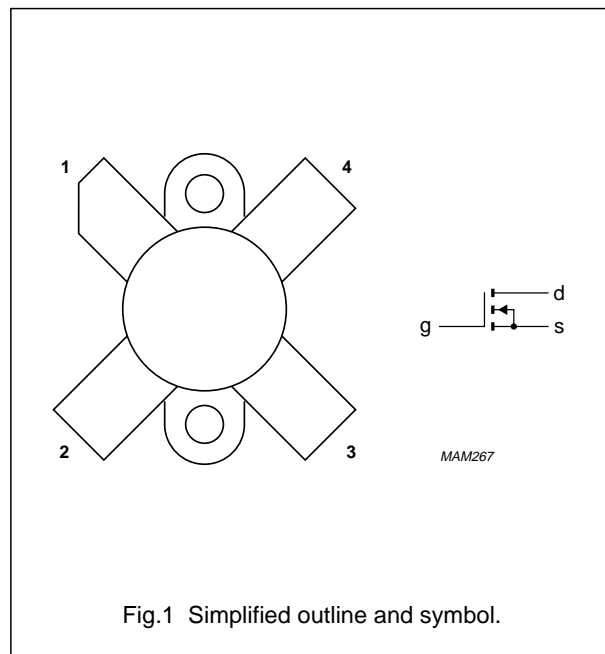

QUICK REFERENCE DATA

RF performance at $T_h = 25\text{ }^\circ\text{C}$ in a common source test circuit.

MODE OF OPERATION	f (MHz)	V_{DS} (V)	P_L (W)	G_p (dB)	η_D (%)
CW, class-B	108	28	80	≥ 16	≥ 55

WARNING
Product and environmental safety - toxic materials
This product contains beryllium oxide. The product is entirely safe provided that the BeO disc is not damaged. All persons who handle, use or dispose of this product should be aware of its nature and of the necessary safety precautions. After use, dispose of as chemical or special waste according to the regulations applying at the location of the user. It must never be thrown out with the general or domestic waste.

VHF power MOS transistor

BLF246

LIMITING VALUES

In accordance with the Absolute Maximum System (IEC 60134).

SYMBOL	PARAMETER	CONDITIONS	MIN.	MAX.	UNIT
V_{DS}	drain-source voltage		–	65	V
V_{GS}	gate-source voltage		–	± 20	V
I_D	DC drain current		–	13	A
P_{tot}	total power dissipation	$T_{amb} \leq 25\text{ }^\circ\text{C}$	–	130	W
T_{stg}	storage temperature		–65	+150	$^\circ\text{C}$
T_j	junction temperature		–	200	$^\circ\text{C}$

THERMAL CHARACTERISTICS

SYMBOL	PARAMETER	VALUE	UNIT
$R_{th\ j-mb}$	thermal resistance from junction to mounting base	1.35	K/W
$R_{th\ mb-h}$	thermal resistance from mounting base to heatsink	0.2	K/W

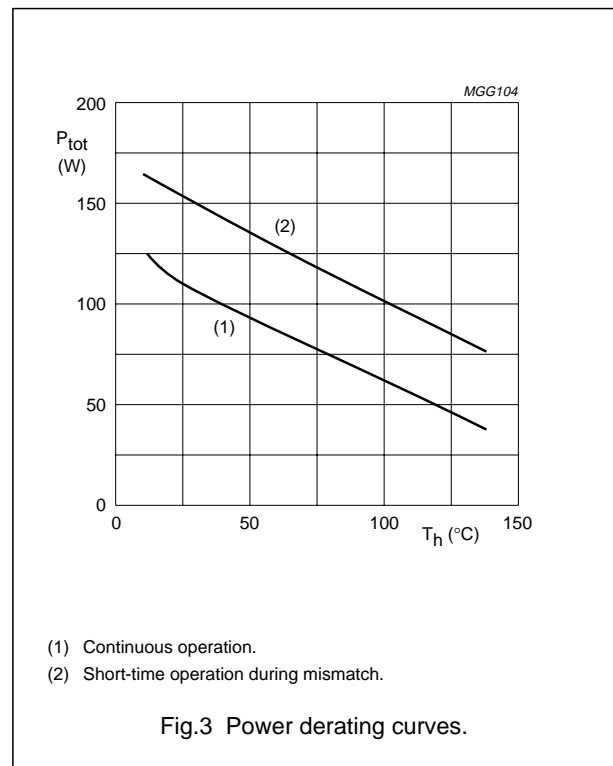
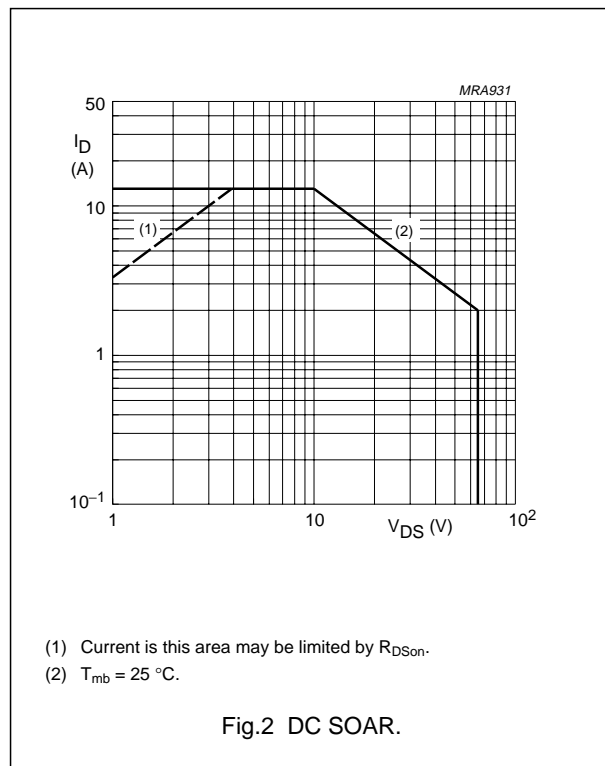

VHF power MOS transistor

BLF246

CHARACTERISTICS $T_j = 25\text{ }^\circ\text{C}$ unless otherwise specified.

SYMBOL	PARAMETER	CONDITIONS	MIN.	TYP.	MAX.	UNIT
$V_{(BR)DSS}$	drain-source breakdown voltage	$V_{GS} = 0$; $I_D = 50\text{ mA}$	65	–	–	V
I_{DSS}	drain-source leakage current	$V_{GS} = 0$; $V_{DS} = 28\text{ V}$	–	–	2.5	mA
I_{GSS}	gate-source leakage current	$V_{GS} = \pm 20\text{ V}$; $V_{DS} = 0$	–	–	1	μA
V_{GSth}	gate-source threshold voltage	$I_D = 50\text{ mA}$; $V_{DS} = 10\text{ V}$	2	–	4.5	V
ΔV_{GS}	gate-source voltage difference of matched pairs	$I_D = 50\text{ mA}$; $V_{DS} = 10\text{ V}$	–	–	100	mV
g_{fs}	forward transconductance	$I_D = 2.5\text{ A}$ or 5 A ; $V_{DS} = 10\text{ V}$	3	4.2	–	S
R_{DSon}	drain-source on-state resistance	$I_D = 5\text{ A}$; $V_{GS} = 10\text{ V}$	–	0.2	0.3	Ω
I_{DSX}	on-state drain current	$V_{GS} = 10\text{ V}$; $V_{DS} = 10\text{ V}$	–	22	–	A
C_{is}	input capacitance	$V_{GS} = 0$; $V_{DS} = 28\text{ V}$; $f = 1\text{ MHz}$	–	225	–	pF
C_{os}	output capacitance	$V_{GS} = 0$; $V_{DS} = 28\text{ V}$; $f = 1\text{ MHz}$	–	180	–	pF
C_{rs}	feedback capacitance	$V_{GS} = 0$; $V_{DS} = 28\text{ V}$; $f = 1\text{ MHz}$	–	25	–	pF

 V_{GS} group indicator

GROUP	LIMITS (V)		GROUP	LIMITS (V)	
	MIN.	MAX.		MIN.	MAX.
A	2.0	2.1	O	3.3	3.4
B	2.1	2.2	P	3.4	3.5
C	2.2	2.3	Q	3.5	3.6
D	2.3	2.4	R	3.6	3.7
E	2.4	2.5	S	3.7	3.8
F	2.5	2.6	T	3.8	3.9
G	2.6	2.7	U	3.9	4.0
H	2.7	2.8	V	4.0	4.1
J	2.8	2.9	W	4.1	4.2
K	2.9	3.0	X	4.2	4.3
L	3.0	3.1	Y	4.3	4.4
M	3.1	3.2	Z	4.4	4.5
N	3.2	3.3			

VHF power MOS transistor

BLF246

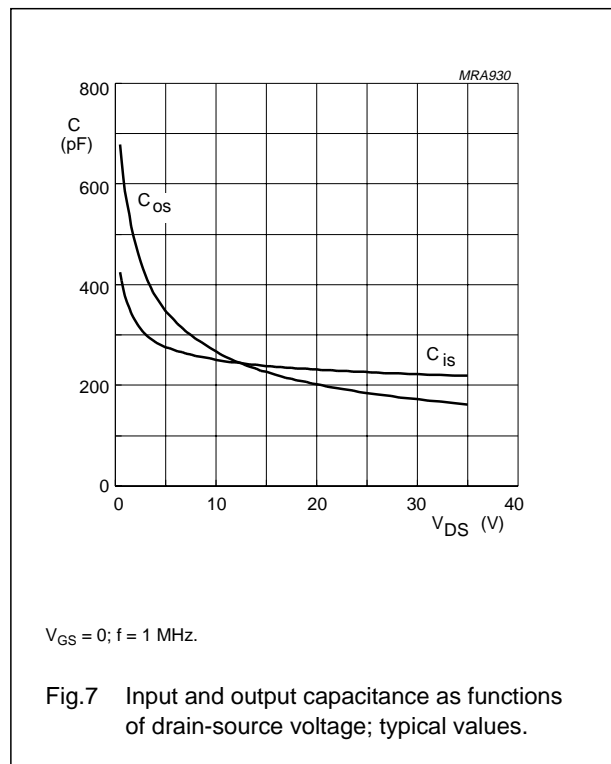
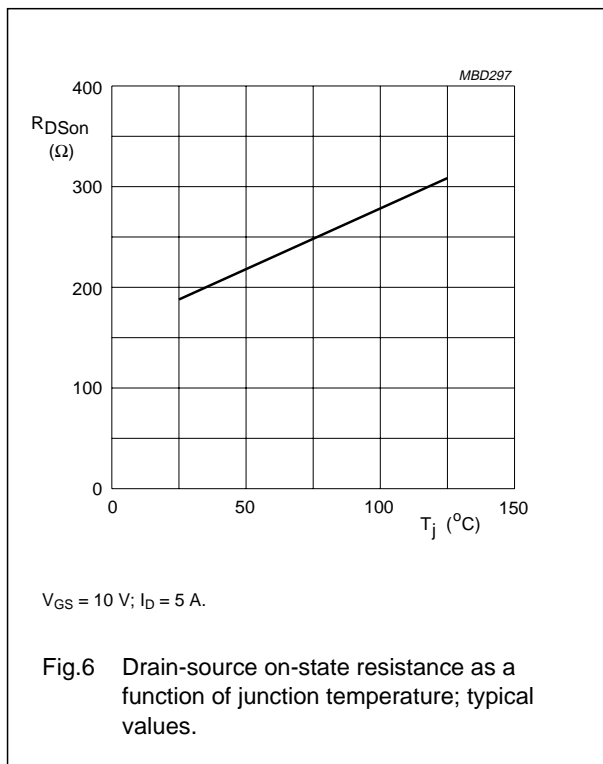
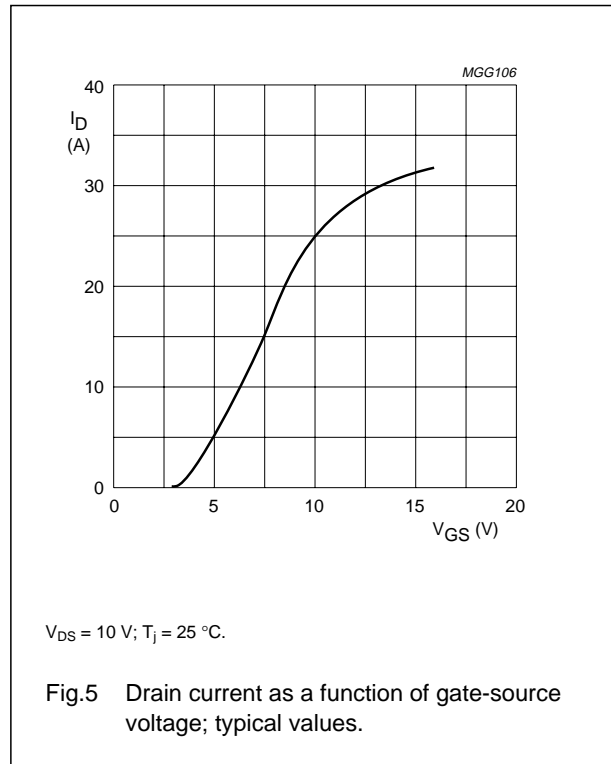
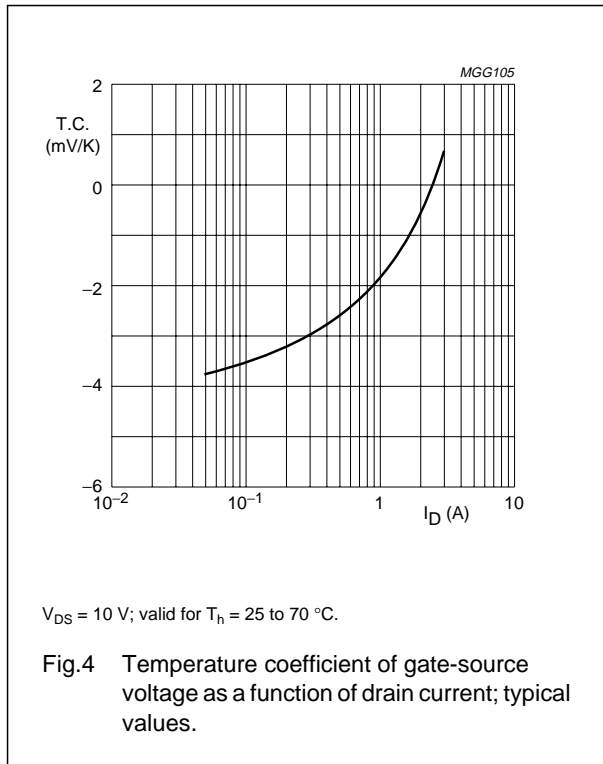

VHF power MOS transistor

BLF246

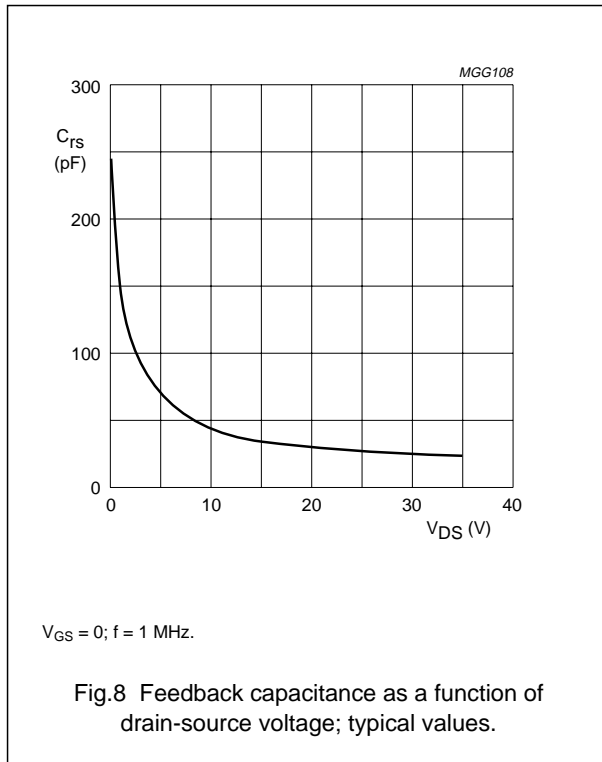
**APPLICATION INFORMATION**

RF performance in CW operation in a common source test circuit.

$T_h = 25$ °C; $R_{th,mb-h} = 0.2$ K/W; $R_{GS} = 12$ Ω unless otherwise specified.

MODE OF OPERATION	f (MHz)	V_{DS} (V)	I_D (A)	P_L (W)	G_p (dB)	η_D (%)
CW, class-B	108	28	0.1	80	>16	>55
CW, class-B	108	28	0.1	80	typ. 18	typ. 65
CW, class-C	108	28	0 ⁽¹⁾	80	typ. 15	typ. 72

Note

- $V_{GS} = 0$ (class-C).

Ruggedness in class-B operation

The BLF246 is capable of withstanding a load mismatch corresponding to VSWR = 50: 1 through all phases under the following conditions: $V_{DS} = 28$ V; $f = 108$ MHz; $T_h = 25$ °C; $R_{th,mb-h} = 0.2$ K/W at rated output power.

Noise figure

Measured with 80 W power-matched source and load in the test circuit (see Fig.9) with $V_{DS} = 28$ V; $I_D = 2$ A; $f = 108$ MHz; $R_{GS} = 27$ Ω; $T_h = 25$ °C; $R_{th,mb-h} = 0.2$ K/W; $F =$ typ. 3 dB.

VHF power MOS transistor

BLF246

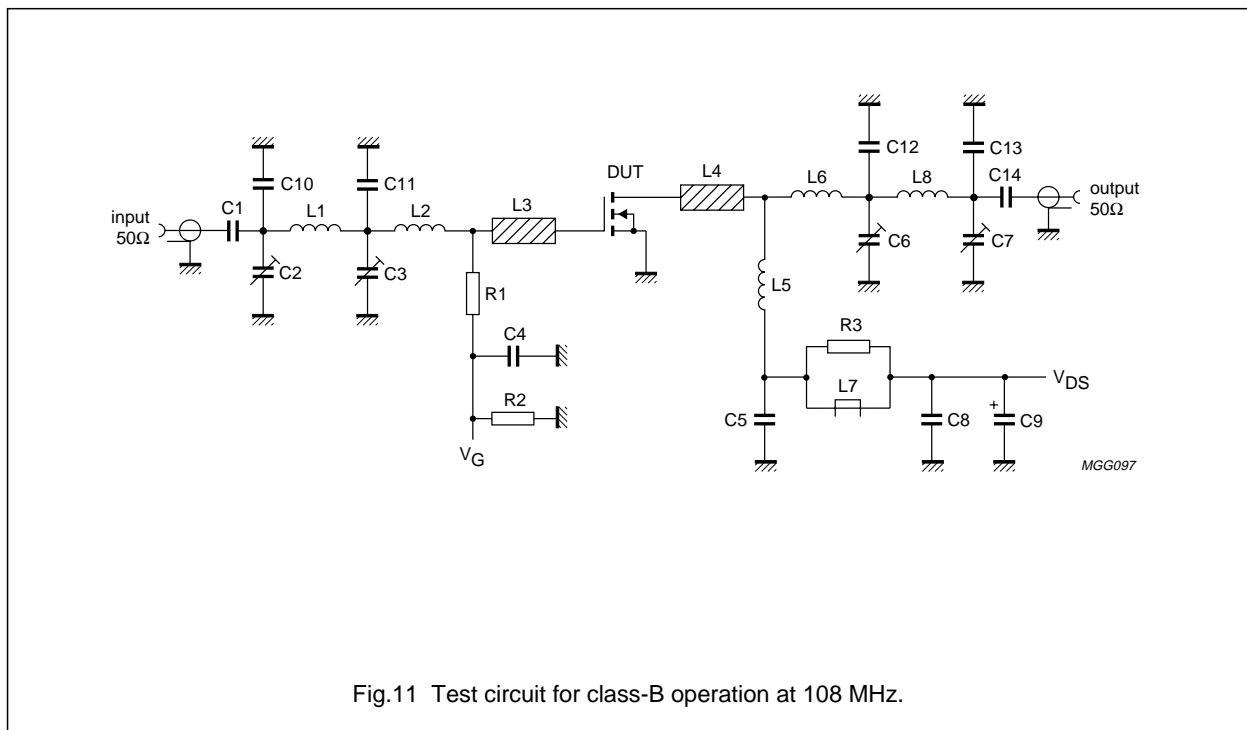
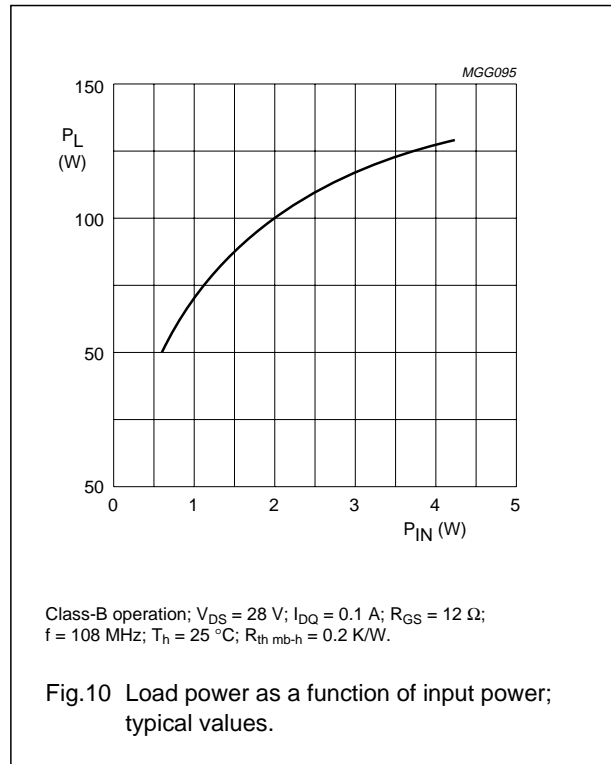
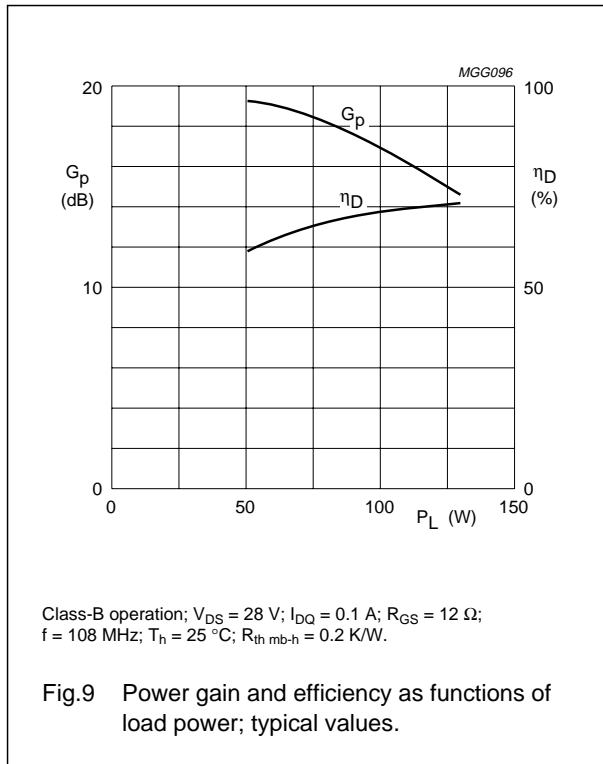

VHF power MOS transistor

BLF246

List of components (see Figs 11 and 12).

COMPONENT	DESCRIPTION	VALUE	DIMENSIONS	CATALOGUE NO.
C1, C4, C5, C8, C14	multilayer ceramic chip capacitor	100 nF		2222 852 47104
C2, C3, C6, C7	film dielectric trimmer	5 to 60 pF		2222 809 08003
C9	electrolytic capacitor	2.2 μ F, 63 V		2222 030 38228
C10	multilayer ceramic chip capacitor; note 1	68 pF + 39 pF in parallel		
C11	multilayer ceramic chip capacitor; note 1	69 pF + 100 pF in parallel		
C12	multilayer ceramic chip capacitor; note 1	2x 100 pF in parallel		
C13	multilayer ceramic chip capacitor; note 1	62 pF		
L1	5 turns enamelled 0.6 mm copper wire	52 nH	length 6.5 mm int. dia. 3 mm leads 2 \times 10 mm	
L2	2 turns enamelled 0.6 mm copper wire	19 nH	length 3.5 mm int. dia. 3 mm leads 2 \times 7.5 mm	
L3, L4	stripline; note 2	31 Ω	length 13 mm width 6 mm	
L5	3 turns enamelled 1.6 mm copper wire	36 nH	length 12 mm int. dia. 6 mm leads 2 \times 5 mm	
L6	hairpin of enamelled 1.6 mm copper wire	14 nH	length 20 mm	
L7	grade 3B Ferroxcube HF choke			4312 020 36640
L8	3 turns enamelled 1.6 mm copper wire	52 nH	length 8 mm int. dia. 6 mm leads 2 \times 9 mm	
R1	metal film resistor	2 \times 24 Ω in parallel, 0.4 W		
R2	metal film resistor	100 k Ω , 0.4 W		
R3	metal film resistor	10 Ω , 0.4 W		

Notes

1. American Technical Ceramics capacitor, type 100B or other capacitor of the same quality.
2. The striplines are mounted on a double copper-clad PCB with epoxy fibre-glass dielectric ($\epsilon_r = 4.5$), thickness 1.6 mm.

VHF power MOS transistor

BLF246

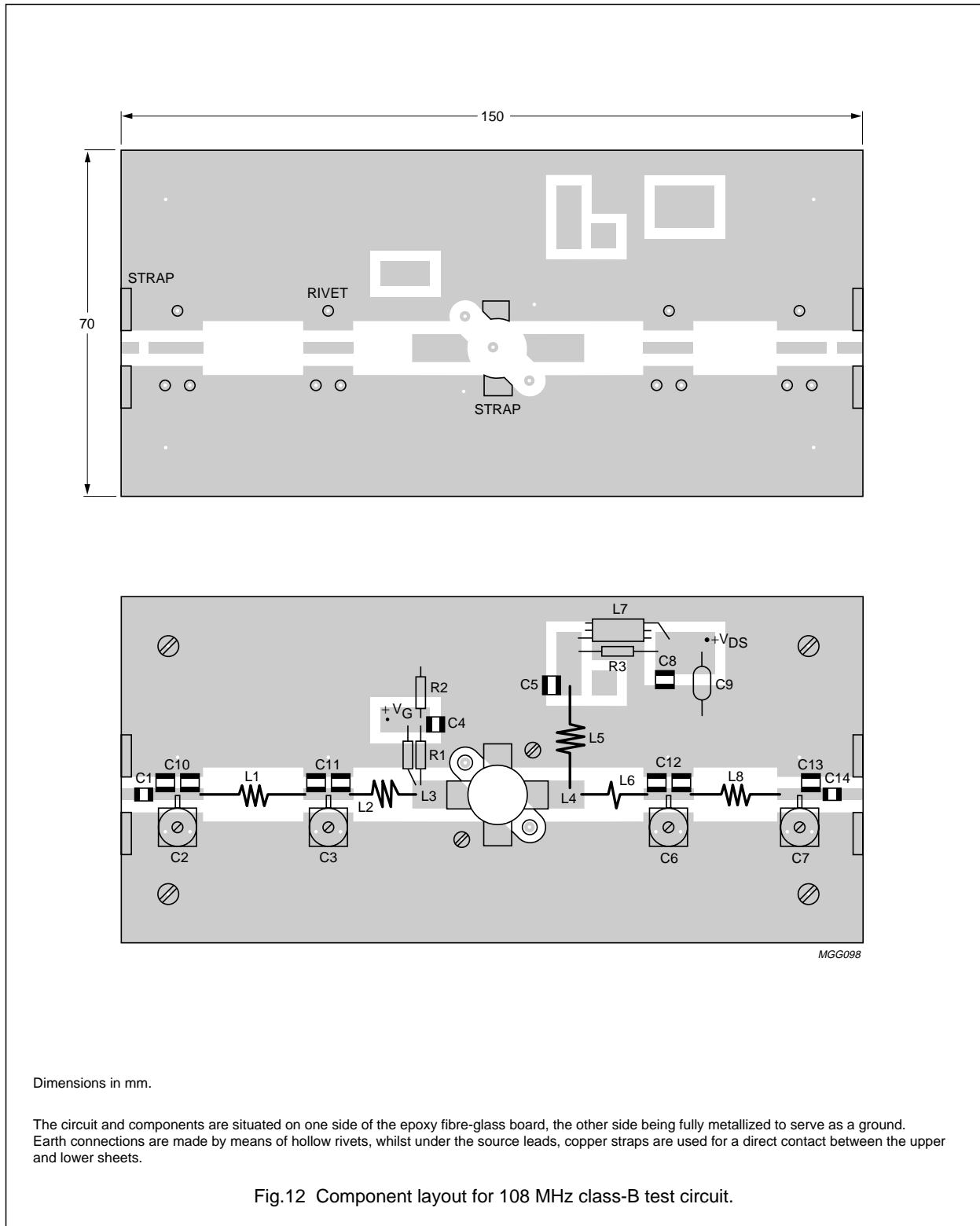

VHF power MOS transistor

BLF246

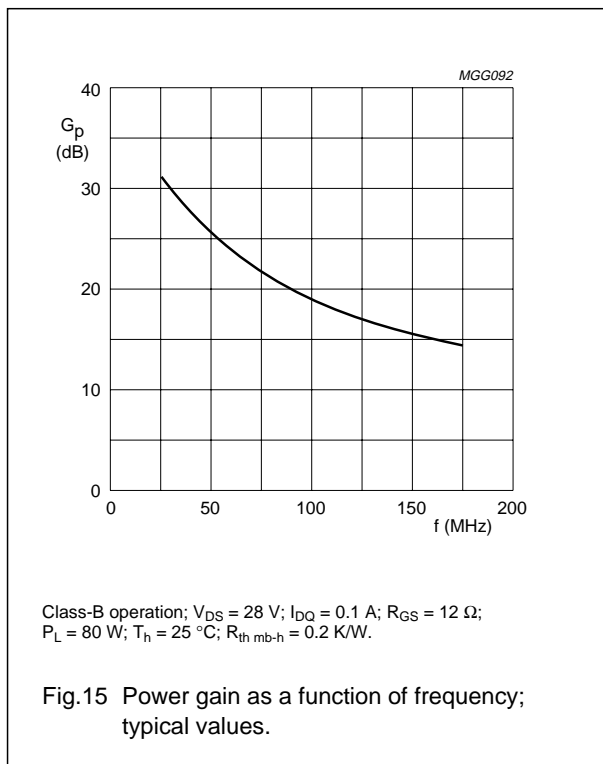
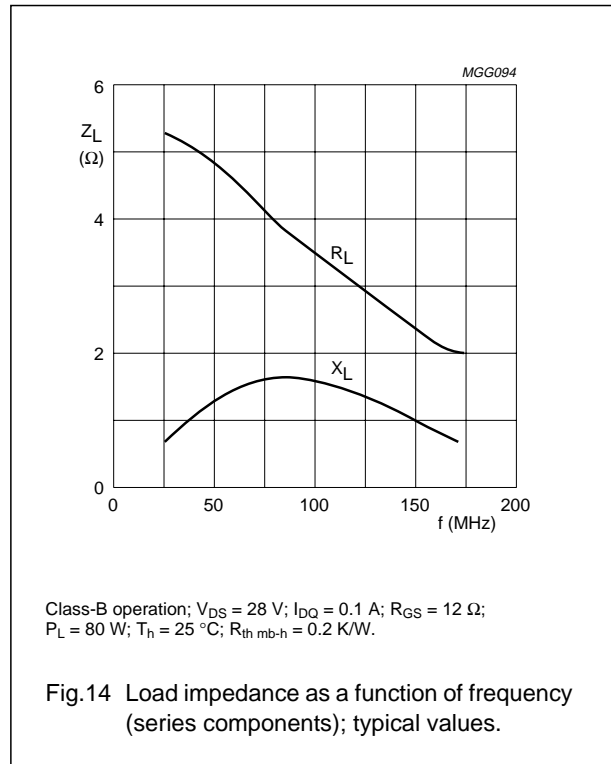
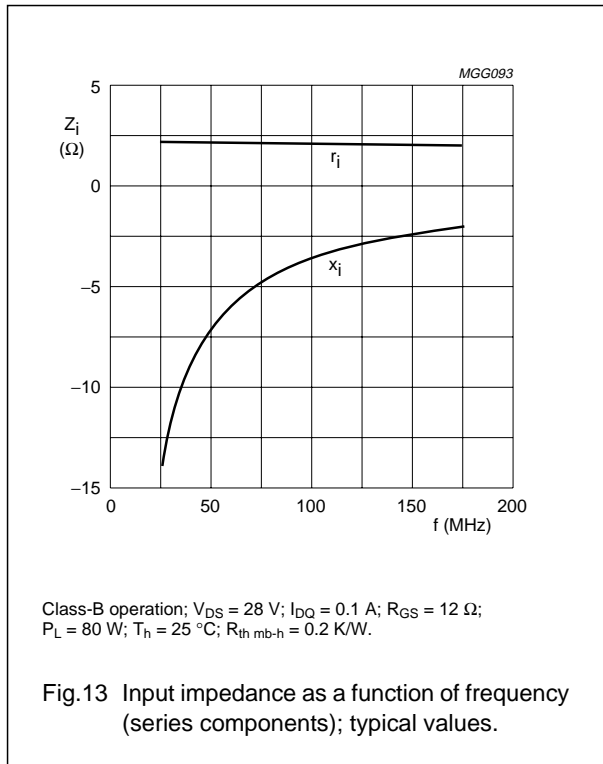

VHF power MOS transistor

BLF246

BLF246 scattering parameters $V_{DS} = 28\text{ V}$; $I_D = 50\text{ mA}$; note 1

f (MHz)	S ₁₁		S ₂₁		S ₁₂		S ₂₂	
	S ₁₁	∠ Φ	S ₂₁	∠ Φ	S ₁₂	∠ Φ	S ₂₂	∠ Φ
5	0.83	-91.4	23.64	124.0	0.05	34.6	0.79	-88.1
10	0.75	-125.6	13.95	103.2	0.05	14.4	0.69	-122.2
20	0.73	-147.1	7.17	84.8	0.06	-2.7	0.68	-143.6
30	0.75	-154.3	4.64	73.4	0.05	-12.7	0.70	-150.6
40	0.78	-157.9	3.30	64.6	0.05	-20.1	0.73	-154.2
50	0.80	-160.3	2.48	57.5	0.04	-25.9	0.77	-156.7
60	0.83	-162.2	1.94	51.4	0.04	-30.5	0.80	-158.9
70	0.86	-164.1	1.56	46.1	0.04	-34.1	0.83	-160.8
80	0.88	-165.8	1.27	41.4	0.03	-36.8	0.85	-162.7
90	0.89	-167.3	1.06	37.6	0.03	-38.6	0.87	-164.3
100	0.91	-168.6	0.89	34.2	0.02	-39.6	0.89	-165.9
125	0.93	-171.7	0.62	27.1	0.02	-37.1	0.92	-169.3
150	0.95	-174.2	0.45	22.3	0.01	-20.7	0.94	-172.1
175	0.96	-176.6	0.34	19.3	0.01	24.3	0.95	-174.6
200	0.97	-178.3	0.27	17.4	0.01	62.3	0.96	-176.7
250	0.98	178.3	0.18	16.1	0.02	81.9	0.97	179.7
300	0.98	175.4	0.13	19.5	0.03	85.4	0.98	176.8
350	0.98	172.6	0.10	24.8	0.04	86.0	0.98	174.1
400	0.98	170.3	0.09	33.5	0.05	85.6	0.98	171.6
450	0.98	167.9	0.08	41.5	0.06	85.3	0.98	169.2
500	0.98	165.6	0.08	49.6	0.06	83.9	0.98	166.9
600	0.98	161.1	0.09	61.3	0.08	81.9	0.98	162.5
700	0.98	156.7	0.10	66.5	0.10	79.6	0.98	158.0
800	0.97	152.0	0.12	69.1	0.12	78.2	0.97	153.7
900	0.97	147.0	0.14	69.5	0.13	76.0	0.97	149.3
1000	0.96	142.0	0.16	70.1	0.16	74.3	0.97	144.8

Note

- For more extensive S-parameters see internet:
<http://www.semiconductors.philips.com.markets/communications/wirelesscommunicationms/broadcast>.

VHF power MOS transistor

BLF246

BLF246 scattering parameters $V_{DS} = 28\text{ V}$; $I_D = 100\text{ mA}$; note 1

f (MHz)	S ₁₁		S ₂₁		S ₁₂		S ₂₂	
	S ₁₁	∠ Φ	S ₂₁	∠ Φ	S ₁₂	∠ Φ	S ₂₂	∠ Φ
5	0.81	-113.3	30.83	116.1	0.04	26.8	0.77	-111.3
10	0.77	-142.3	17.04	99.5	0.04	11.1	0.72	-140.7
20	0.76	-158.6	8.64	85.7	0.04	-0.8	0.71	-156.6
30	0.77	-163.5	5.67	77.3	0.04	-7.7	0.72	-161.5
40	0.79	-165.8	4.12	70.5	0.04	-12.7	0.74	-163.3
50	0.80	-167.2	3.18	64.6	0.03	-16.7	0.76	-164.5
60	0.82	-168.2	2.54	59.3	0.03	-19.9	0.78	-165.4
70	0.84	-169.2	2.08	54.5	0.03	-22.4	0.80	-166.3
80	0.85	-170.0	1.74	50.4	0.03	-24.0	0.82	-167.1
90	0.87	-170.9	1.48	46.6	0.02	-24.9	0.84	-168.0
100	0.88	-171.8	1.27	43.0	0.02	-25.1	0.86	-169.0
125	0.90	-173.9	0.90	35.4	0.02	-20.6	0.89	-171.3
150	0.92	-175.9	0.67	29.8	0.01	-5.0	0.91	-173.3
175	0.94	-177.8	0.51	26.0	0.01	24.7	0.93	-175.2
200	0.95	-179.6	0.41	22.7	0.01	52.6	0.94	-177.1
250	0.96	177.3	0.27	18.6	0.02	76.2	0.96	179.7
300	0.97	174.4	0.20	17.8	0.03	82.2	0.97	176.9
350	0.97	171.7	0.15	19.4	0.03	84.2	0.97	174.3
400	0.97	169.2	0.13	23.4	0.04	84.3	0.98	171.9
450	0.97	166.7	0.11	28.4	0.05	84.6	0.98	169.6
500	0.97	164.3	0.10	34.9	0.06	83.3	0.98	167.4
600	0.97	159.5	0.09	46.8	0.07	81.6	0.98	163.1
700	0.96	154.5	0.10	55.1	0.09	79.5	0.98	158.8
800	0.96	149.3	0.11	61.0	0.10	78.8	0.98	154.5
900	0.95	143.6	0.12	63.0	0.11	76.3	0.97	150.0
1000	0.92	136.3	0.12	67.1	0.12	78.0	0.97	145.2

Note

- For more extensive S-parameters see internet:
<http://www.semiconductors.philips.com.markets/communications/wirelesscommunicationms/broadcast>.

VHF power MOS transistor

BLF246

PACKAGE OUTLINE

Flanged ceramic package; 2 mounting holes; 4 leads

SOT121B

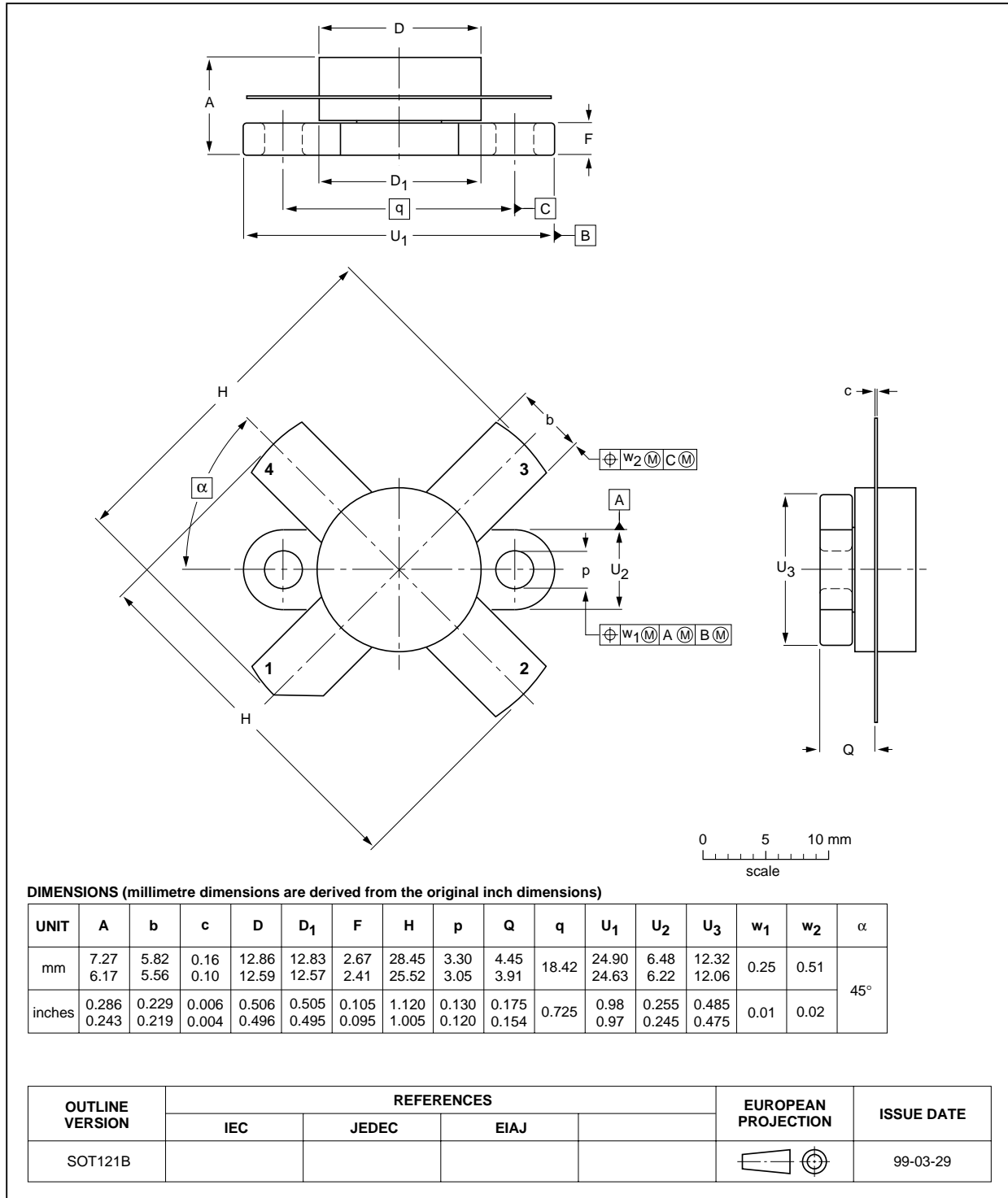

VHF power MOS transistor

BLF246

DATA SHEET STATUS

LEVEL	DATA SHEET STATUS ⁽¹⁾	PRODUCT STATUS ⁽²⁾⁽³⁾	DEFINITION
I	Objective data	Development	This data sheet contains data from the objective specification for product development. Philips Semiconductors reserves the right to change the specification in any manner without notice.
II	Preliminary data	Qualification	This data sheet contains data from the preliminary specification. Supplementary data will be published at a later date. Philips Semiconductors reserves the right to change the specification without notice, in order to improve the design and supply the best possible product.
III	Product data	Production	This data sheet contains data from the product specification. Philips Semiconductors reserves the right to make changes at any time in order to improve the design, manufacturing and supply. Relevant changes will be communicated via a Customer Product/Process Change Notification (CPCN).

Notes

1. Please consult the most recently issued data sheet before initiating or completing a design.
2. The product status of the device(s) described in this data sheet may have changed since this data sheet was published. The latest information is available on the Internet at URL <http://www.semiconductors.philips.com>.
3. For data sheets describing multiple type numbers, the highest-level product status determines the data sheet status.

DEFINITIONS

Short-form specification — The data in a short-form specification is extracted from a full data sheet with the same type number and title. For detailed information see the relevant data sheet or data handbook.

Limiting values definition — Limiting values given are in accordance with the Absolute Maximum Rating System (IEC 60134). Stress above one or more of the limiting values may cause permanent damage to the device.

These are stress ratings only and operation of the device at these or at any other conditions above those given in the Characteristics sections of the specification is not implied. Exposure to limiting values for extended periods may affect device reliability.

Application information — Applications that are described herein for any of these products are for illustrative purposes only. Philips Semiconductors make no representation or warranty that such applications will be suitable for the specified use without further testing or modification.

DISCLAIMERS

Life support applications — These products are not designed for use in life support appliances, devices, or systems where malfunction of these products can reasonably be expected to result in personal injury. Philips Semiconductors customers using or selling these products for use in such applications do so at their own risk and agree to fully indemnify Philips Semiconductors for any damages resulting from such application.

Right to make changes — Philips Semiconductors reserves the right to make changes in the products - including circuits, standard cells, and/or software - described or contained herein in order to improve design and/or performance. When the product is in full production (status 'Production'), relevant changes will be communicated via a Customer Product/Process Change Notification (CPCN). Philips Semiconductors assumes no responsibility or liability for the use of any of these products, conveys no licence or title under any patent, copyright, or mask work right to these products, and makes no representations or warranties that these products are free from patent, copyright, or mask work right infringement, unless otherwise specified.

Philips Semiconductors – a worldwide company

Contact information

For additional information please visit <http://www.semiconductors.philips.com>. Fax: **+31 40 27 24825**

For sales offices addresses send e-mail to: sales.addresses@www.semiconductors.philips.com.

© Koninklijke Philips Electronics N.V. 2003

SCA75

All rights are reserved. Reproduction in whole or in part is prohibited without the prior written consent of the copyright owner.

The information presented in this document does not form part of any quotation or contract, is believed to be accurate and reliable and may be changed without notice. No liability will be accepted by the publisher for any consequence of its use. Publication thereof does not convey nor imply any license under patent- or other industrial or intellectual property rights.

Printed in The Netherlands

613524/04/pp15

Date of release: 2003 Aug 05

Document order number: 9397 750 11597

Let's make things better.

**Philips
Semiconductors**



PHILIPS