

4

3

2

1

THIS DRAWING IS UNPUBLISHED. RELEASED FOR PUBLICATION
 © COPYRIGHT - By - ALL RIGHTS RESERVED.

LOC	DIST	REVISIONS		
FB	00	P	LTR	DESCRIPTION
		P		REVISED PER ECO-11-005033
				DATE
				24MAR11
				DWN
				RK
				APVD
				HMR

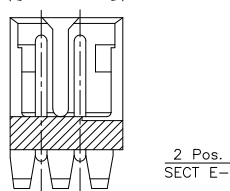
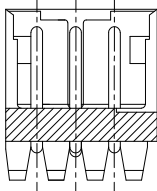
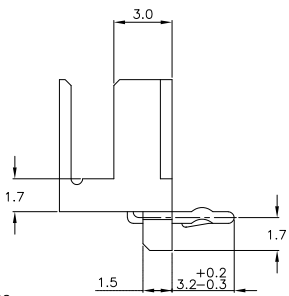
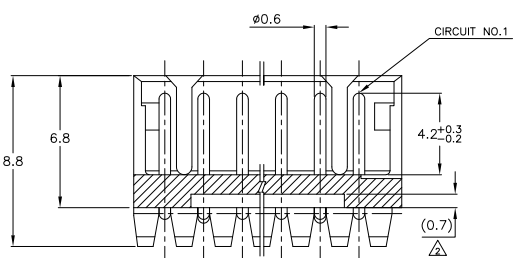
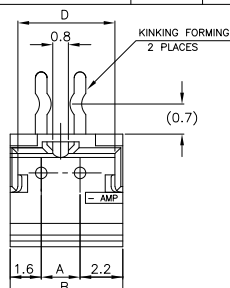
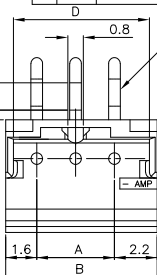
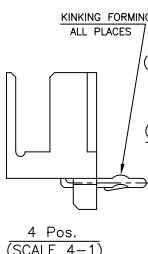
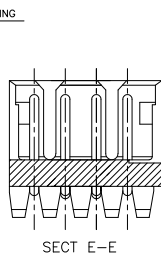
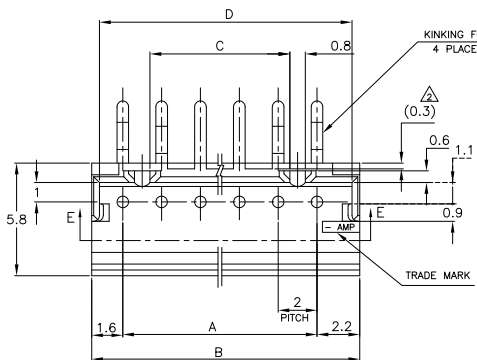

7-292250-5	5-292250-5	3-292250-5	1-292250-5	15	28	31.8	25.2	31.0
7- -4	5- -4	3- -4	1- -4	14	26	29.8	23.2	29.0
7- -3	5- -3	3- -3	1- -3	13	24	27.8	21.2	27.0
7- -2	5- -2	3- -2	1- -2	12	22	25.8	19.2	25.0
7- -1	5- -1	3- -1	1- -1	11	20	23.8	17.2	23.0
7- -0	5- -0	3- -0	1- -0	10	18	21.8	15.2	21.0
6- -9	4- -9	2- -9	-9	9	16	19.8	13.2	19.0
6- -8	4- -8	2- -8	-8	8	14	17.8	11.2	17.0
6- -7	4- -7	2- -7	-7	7	12	15.8	9.2	15.0
6- -6	4- -6	2- -6	-6	6	10	13.8	7.2	13.0
6- -5	4- -5	2- -5	-5	5	8	11.8	5.2	11.0
6- -4	4- -4	2- -4	-4	4	6	9.8	3.2	9.0
6- -3	4- -3	2- -3	-3	3	4	7.8	—	7.0
6-292250-2	4-292250-2	2-292250-2	292250-2	2	2	5.8	—	5.0
BLACK	YELLOW	BLUE	NATURAL	Pos.	A	B	C	D

NOTES:
 1. MATERIAL: HOUSING - NYLON 66 (UL94V-0)
 POST - TIN BRASS
 Δ 12 POS ~ 15 POS ONLY

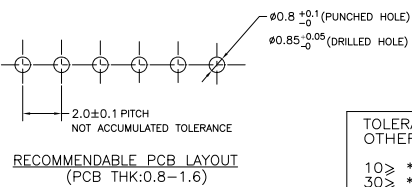

TOLERANCES UNLESS OTHERWISE SPECIFIED:

10 > *	: ±0.2
30 > * > 10	: ±0.25
100 > * > 30	: ±0.3
ANGLE	: ±3°

THIS DRAWING IS A CONTROLLED DOCUMENT.

DIMENSIONS:	TOLERANCES UNLESS OTHERWISE SPECIFIED:
mm	
0 PLC	±
1 PLC	±
2 PLC	±
3 PLC	±
4 PLC	±
ANGLES	±
FINISH	
MATERIAL	SEE NOTE

DWN	S.XU	31JAN03	STE TE Connectivity
CHK	S.YAO	31JAN03	
APVD	T.SASAKI	31JAN03	
NAME	POST HEADER ASS'Y BOX-H DIP (AMP CT CONNECTOR 2mm PITCH)		
PRODUCT SPEC	108-60016		
APPLICATION SPEC			
SIZE	A3	CAGE CODE	00779
DRAWING NO	C-292250		RESTRICTED TO
WEIGHT			—
CUSTOMER DRAWING	SCALE	5:1	SHEET 1 of 1
			REV P