

LOC	DIST	P	LTR	REVISED	DESCRIPTION	DATE	DMN	APPD
ES	00	C3		REVISED ECR-111-021545		24OCT11	C.Z	S.Y

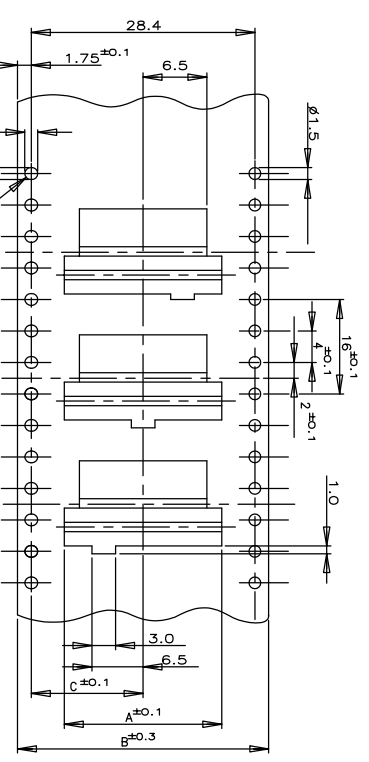

(AS SHOWN : 3P)

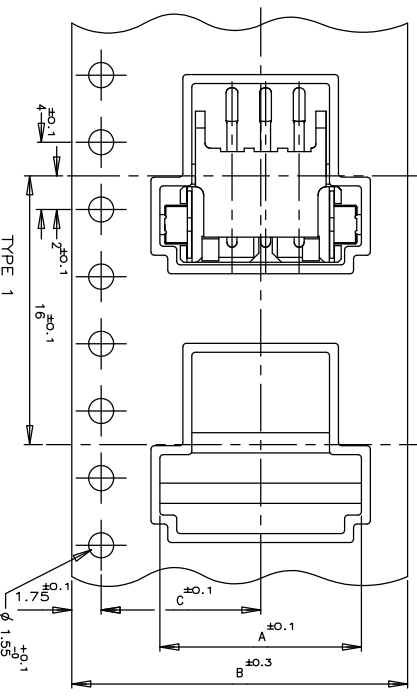
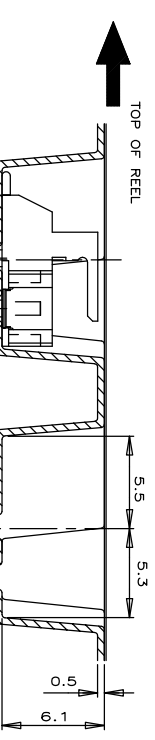

THREE KINDS OF DIFFERENT POCKETS AS 1 SET USED FOR 7P ONLY

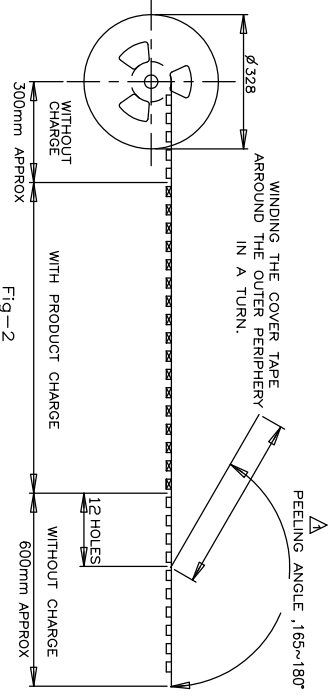
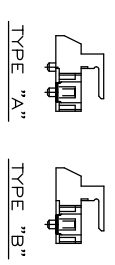

COLOR		WITH		WITHOUT		WITH		WITHOUT	
PLATE	TAPE TYPE	TYPE OF BOSS	TYPE OF C	TYPE OF B	TYPE OF A	QTY/REEL	Pos	TAPING P/N	
BLACK	TYPE 2	B	20.2	44	24	500	9	1-292173-9	-8
			20.2	44	22		8	1-	-8
		B	14.2	32	20		7	1-	-7
			14.2	32	18		6	1-	-6
		B	11.5	24	16		5	1-	-5
			11.5	24	14		4	1-	-4
	TYPE 3	A	11.5	24	10		2	1-	-2
			20.2	44	24		9	0-	-9
		B	20.2	44	22		8	0-	-8
			14.2	32	20		7	0-	-7
		B	14.2	32	18		6	0-	-6
			11.5	24	16		5	0-	-5
B	11.5	24	14		4	0-	-4		
					3	0-	-3		

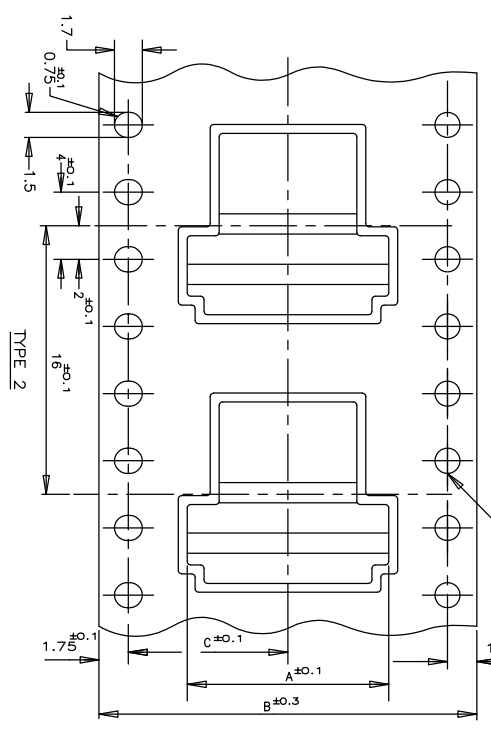

TOLERANCE UNLESS OTHERWISE SPECIFIED:
 10~> ±0.2
 30~> ±0.25
 100~> ±0.3
 ANGLE ±3°
NOTES:
 ▲ PEELING RESISTANCE : 0.198N~0.688N (20gf~70gf)
 SPEED : 300mm/min

THIS DRAWING IS A CONTROLLED DOCUMENT.	DMN	JACK HOU	21SEP10
DIMENSIONS: MM	CHK	MARTIN LI	21SEP10
TOLERANCES UNLESS OTHERWISE SPECIFIED:	APPD	STEVEN YAO	21SEP10
0 P.L.C 1 P.L.C 2 P.L.C 3 P.L.C 4 P.L.C	PRODUCT SPEC		
FINISH ANGLES	APPLICATION SPEC		
MATERIAL	WEIGHT		
CUSTOMER DRAWING			

ON TAPING (EMBOSS)		TE CONNECTIVITY	
CT CONNECTOR POST HEADER ASS'Y		TE Connectivity	
(BOX-H SMT TYPE W/BOSS & TAIL)			
NAME	SIZE	SCALE	SHEET
A3	00779	1/1	6
CASE CODE	DRAWING NO		REV
292173			C3

NO.	DATE	DESCRIPTION	BY
1		SEE SHEET 1	

(AS SHOWN : 3P)

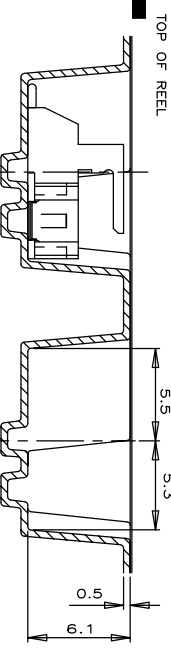
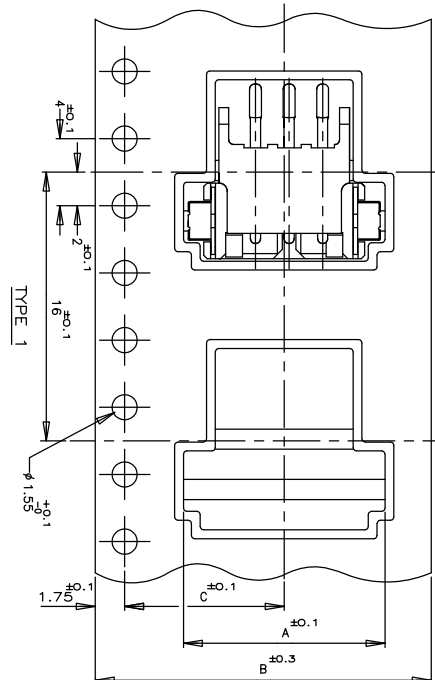

TYPE 3 FOR 7P ONLY
THREE KINDS OF DIFFERENT POCKETS AS 1 SET
USED FOR 7P ONLY

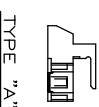

WINDING THE COVER TAPE AROUND THE OUTER PERIPHERY IN A TURN.
PEELING ANGLE : 165~180°

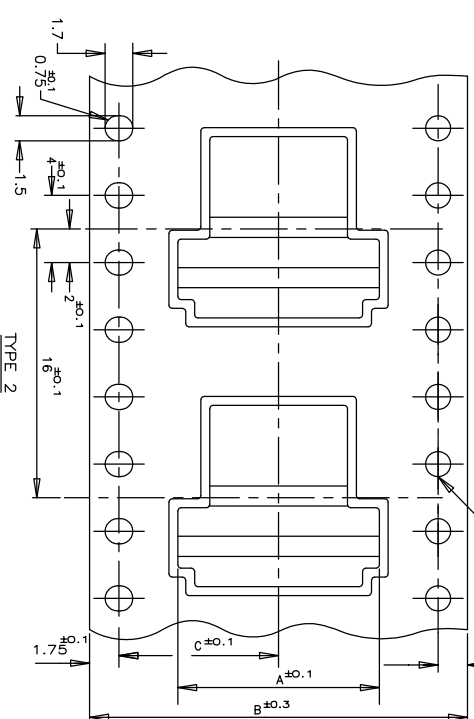
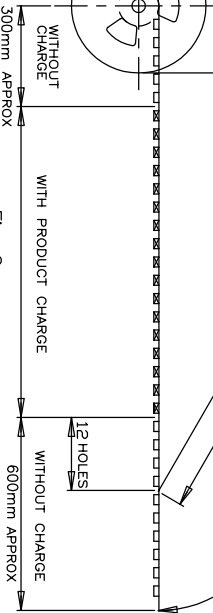

NOTE:

Δ PEELING RESISTANCE : 0.196N~0.688N (20gf~70gf)
SPEED : 300mm/min

1470-19 (3/11)

THIS DRAWING IS A CONTROLLED DOCUMENT.

DIM.	CHK.	DRAWN
APRO		

NAME	ON TAPING (EMBOSS)
TE CT CONNECTOR POST HEADER ASS'Y (BOX-H SMT TYPE W/O BOSS & W/ TAIL)	
CAGE CODE	
DRAWING NO	
SIZE	
RESTRICTED TO	

SCALE: 1/1 SHEET: 2 OF 6 REV: C3

TYPE	SIZE	QTY/ REEL	POST	TAPING P/N			
BLACK	TYPE 1 A	11.5	24	10	500	2	2-292173-2
	TYPE 2 A	20.2	44	24	9	2	2-292173-9
	TYPE 3 A	14.2	32	20	7	3	-7
	TYPE 2 A	11.5	24	16	5	3	-5
	TYPE 1 A	11.5	24	10	3	3	-3
NATURAL	TYPE 1 A	11.5	24	10	2	3	-2
	TYPE 2 A	20.2	44	24	9	2	-9
	TYPE 3 A	14.2	32	20	7	2	-7
	TYPE 2 A	14.2	32	18	6	2	-6
	TYPE 1 A	11.5	24	16	5	2	-5

LOC	DIST	REV	DESCRIPTION	DATE	DMN	APPD
ES	00					
P	LTR					
			SEE SHEET 1			

(AS SHOWN : -4)

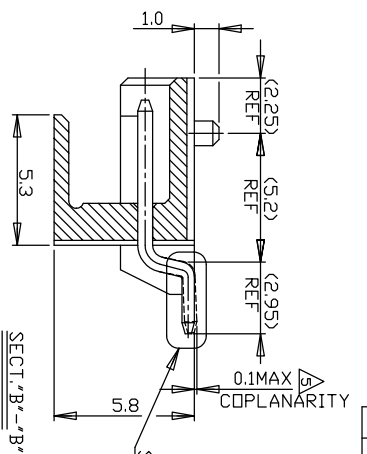
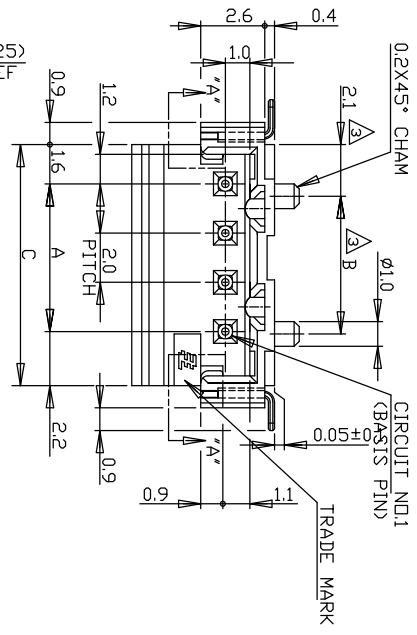

- NOTES:
1. MATERIAL:HSG-6T PKG.F.30X(U)94V(-0)
COLDBLACK NATURAL
POST: TIN BRASS
TAIL: TIN BRASS
OCCUPANT AREA ON PC BOARD
4P&3P
2P&3P
TO BE MEASURED WITH CONNECTOR PLACED ON HORIZONTAL DATUM SURFACE, FLAT OF SOLDER TINE AND TAIL FROM DATUM SURFACE IS 0.1mm MAX

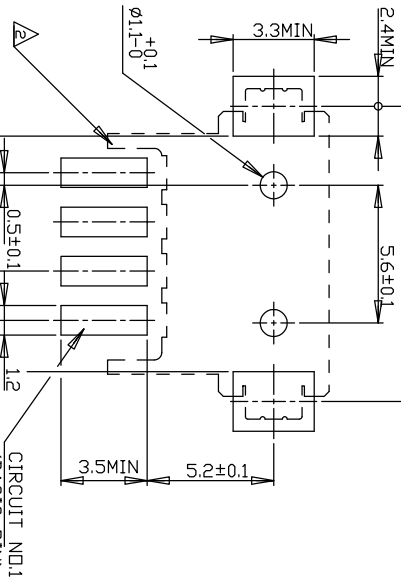
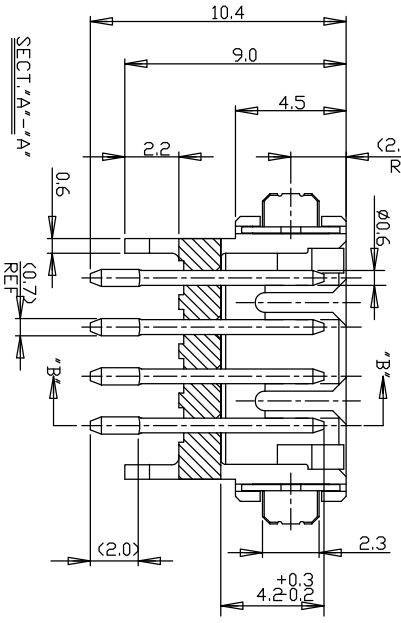

A	B	C	D	Pos.	P/N
16.0	15.6	19.8	22.0	9	1-292173-9
14.0	13.6	17.8	20.0	8	1-292173-8
12.0	11.6	15.8	18.0	7	1-292173-7
10.0	9.6	13.8	16.0	6	1-292173-6
8.0	7.6	11.8	14.0	5	1-292173-5
6.0	5.6	9.8	12.0	4	1-292173-4
4.0	4.0	7.8	10.0	3	1-292173-3
2.0	2.0	5.8	8.0	2	1-292173-2



TE Connectivity

SMT TYPE POST HDR ASS'Y (H)
WITH BOSS & TAIL TYPE
(TE CT CONN. 2mm PITCH)

NAME	APND	CHK	DMN
PRODUCT SPEC	108-60016		
APPLICATION SPEC			
WEIGHT			
CUSTOMER DRAWING			
SIZE	A3	00779	292173
SCALE	5:1	SHEET	3 OF 6
REV	C3		

TOLERANCES UNLESS OTHERWISE SPECIFIED:
10.0* ±0.2
30.0*±10 ±0.25
100.0*±30 ±0.3
ANGEL ±3°

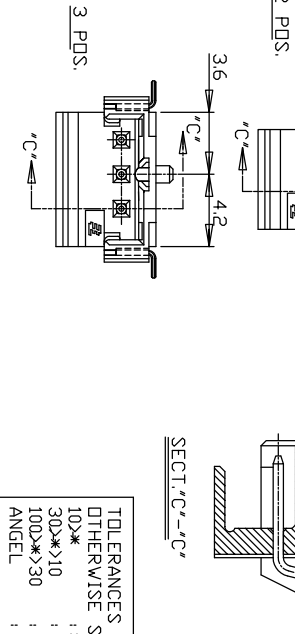

LOC	DIST	REV	DESCRIPTION	DATE	DMN	APPD
ES	00					
P	LTR		SEE SHEET 1			

LAYOUT FOR 292173-X,1-292173-X

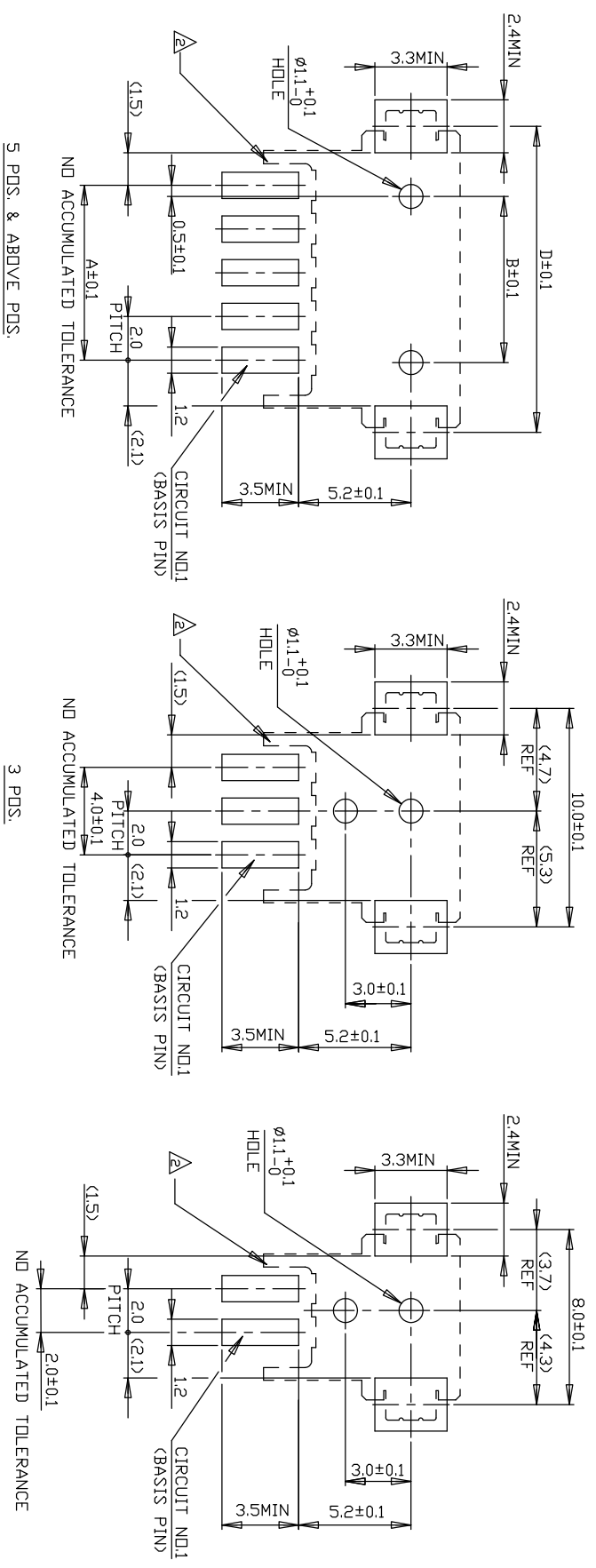

5 PDS. & ABOVE PDS.

3 PDS.

2 PDS.

RECOMMENDED P.C. BOARD LAYOUT
(P.C.B. THK:0.8mm MIN)

THIS DRAWING IS A CONTROLLED DOCUMENT.

DIM	CHK	APD	NAME
-	-	-	DMN
-	-	-	CHK

DMN: TE Connectivity

DIMENSIONS:	TOLERANCES UNLESS OTHERWISE SPECIFIED:
MM	±
0 PL	±
1 PL	±
2 PL	±
3 PL	±
4 PL	±
ANGLES	±
FINISH	±

PRODUCT SPEC: SMT TYPE POST HDR ASS'Y (H)
WITH BOSS & TAIL TYPE
(TE CT CONN. 2mm PITCH)

APPLICATION SPEC: DRAWING NO: A3 00779 ©=292173

CUSTOMER DRAWING: RESTRICTED TO

SCALE: 5:1 SHEET: 4 OF 6 REV: C3

REVISIONS

NO	DESCRIPTION	DATE	DMN	APRD
1				

(AS SHOWN : 4P)

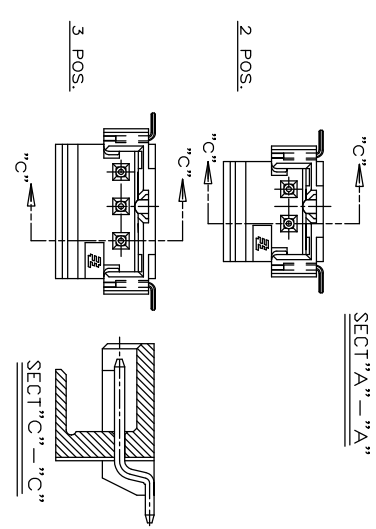
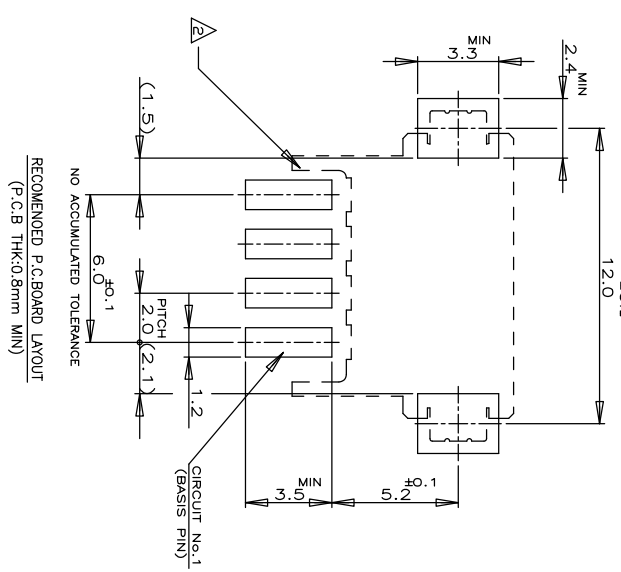
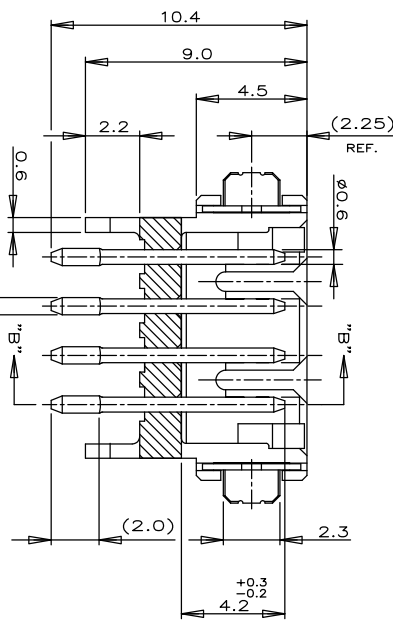
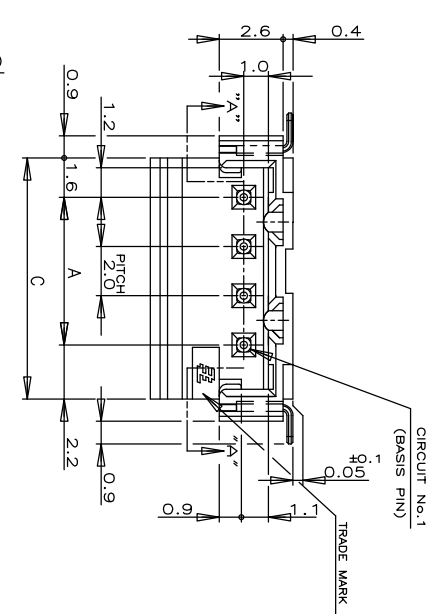
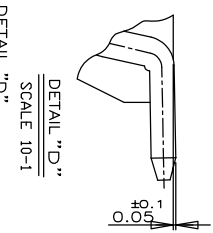

- NOTES:
- 1. MATERIAL : HSG-6T PA(G.F.30%)(UL94V-0)
COLOR:BLACK,NATURAL
POST:TIN BRASS
TAIL: TIN BRASS
OCCUPANT AREA ON PC BOARD TO BE MEASURED WITH CONNECTOR PLACED ON HORIZONTAL DATUM SURFACE.FLOAT OF SOLDER TINE AND TAIL FROM DATUM SURFACE IS 0.1mm MAX

SIZE	16.0	19.8	22.0	9	3-292173-9	2-292173-9
14.0	17.8	20.0	8	3-	-8	2- -8
12.0	15.8	18.0	7	3-	-7	2- -7
10.0	13.8	16.0	6	3-	-6	2- -6
8.0	11.8	14.0	5	3-	-5	2- -5
6.0	9.8	12.0	4	3-	-4	2- -4
4.0	7.8	10.0	3	3-	-3	2- -3
2.0	5.8	8.0	2	3-	-2	2- -2

A	C	D	Pos.	P/N
			NATURAL	BLACK

THIS DRAWING IS A CONTROLLED DOCUMENT.

DIMENSIONS: MM

DIM: / CHK: /

APRD: /

PRODUCT SPEC: 108-60016

APPLICATION SPEC: /

WEIGHT: /

CUSTOMER DRAWING: /

NAME: SMT TYPE POST HDR ASS'Y (BOX-H)
W/O BOSS WITH TAIL TYPE
(IE CT CONN. 2mm PITCH)

DATE: / /

DMN: /

APRD: /

SCALE: 5:1

SHEET: 5 OF 6

REV: C3

RESTRICTED

TE Connectivity

TOLERANCES UNLESS OTHERWISE SPECIFIED:

10 μ m	+0.2
30 μ m	+0.25
100 μ m	+0.3
ANGLE	+3°

THIS DRAWING IS UNPUBLISHED.
 © COPYRIGHT - By -
 RELEASED FOR PUBLICATION
 ALL RIGHTS RESERVED

LOC	DIST	REVISONS	
ES 00		DESCRIPTION	DATE
P	LTR		DMN
-	SEE SHEET 1		APRD

LAYOUT FOR 2-292173-X-3-2-292173-X

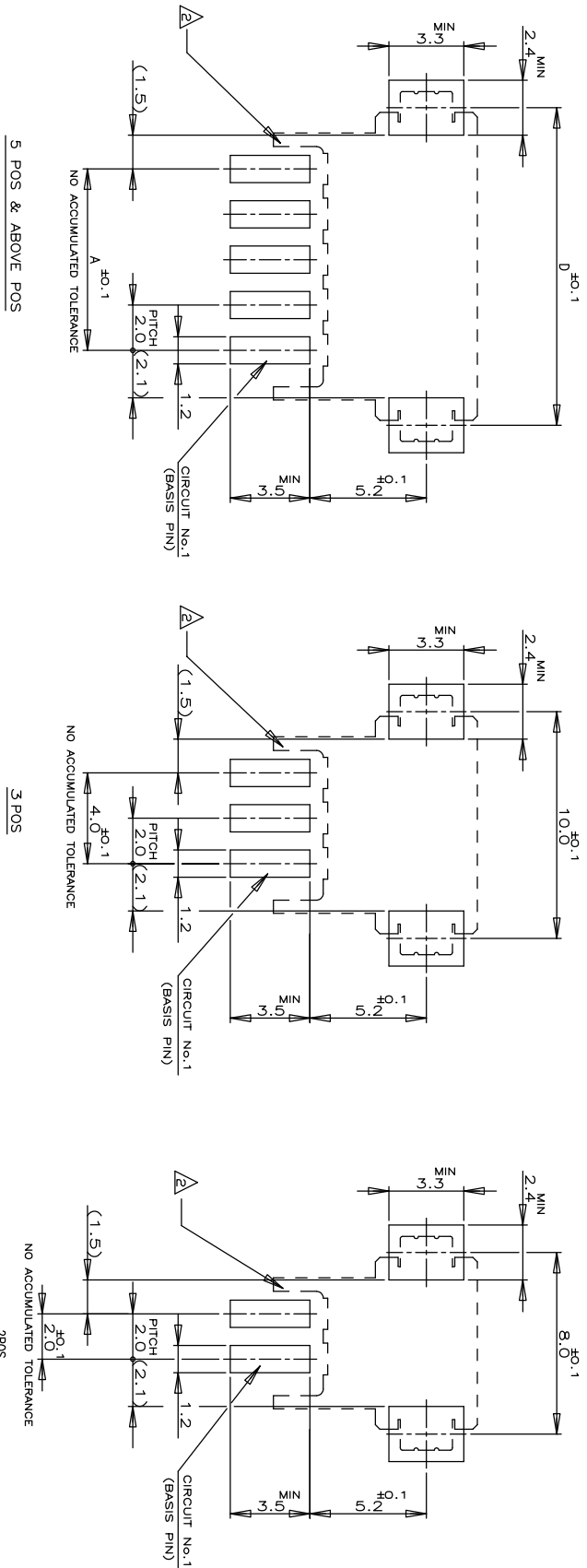

RECOMMENDED P.C.BOARD LAYOUT
 (P.C.B THK:0.8mm MIN)

THIS DRAWING IS A CONTROLLED DOCUMENT.		DMN	APRD	NAME
DIMENSIONS: MM		CHK		STE TE Connectivity
TOLERANCES UNLESS OTHERWISE SPECIFIED:		APRD		SMT TYPE POST HDR ASS'Y (H)
0 PLG	±			W/O WITH TAIL TYPE
1 PLG	±			(IE CT CONN. 2mm PITCH)
2 PLG	±			
3 PLG	±			
4 PLG	±			
ANGLES	±			
FINISH	±			
MATERIAL				
PRODUCT SPEC				
APPLICATION SPEC				
WEIGHT				
CUSTOMER DRAWING				
SIZE				
CASE CODE				
DRAWING NO				
A3 00779				
SCALE				
5:1				
SHEET				
6 OF 6				
REV				
C3				