

4

3

2

1

THIS DRAWING IS UNPUBLISHED. RELEASED FOR PUBLICATION
COPYRIGHT BY TYCO ELECTRONICS CORPORATION. ALL RIGHTS RESERVED.

LOC	DIST	REVISIONS			
P	LTR	DESCRIPTION	DATE	DWN	APVD
FB	00	RELEASED	FB00-0013-03	23JAN03	J.J. T.S.

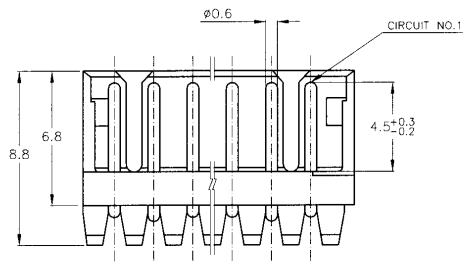
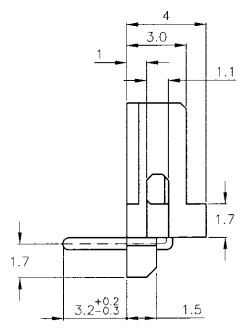
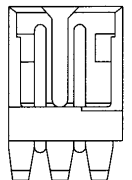
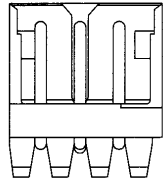
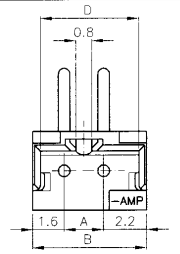
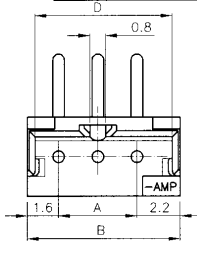
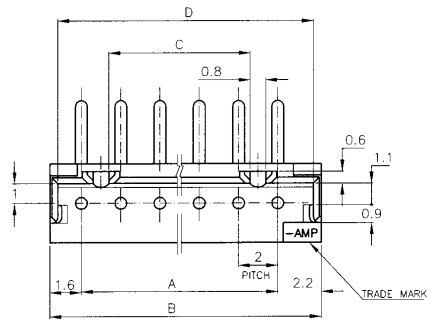

4~15 Pos.

NOTES:

- 1.MATERIAL: HOUSING - NYLON 66 (UL94V-0)
POST - TIN BRASS
- 2.THIS PRODUCT IS "NO-KINK" VERSION OF P/N 292253
- 3.MATING RECEPTACLE P/N 173977

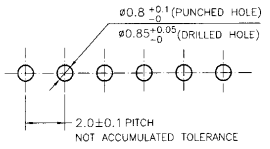

RECOMMENDABLE PCB LAYOUT
(PCB THK:0.8-1.6)

TOLERANCES UNLESS OTHERWISE SPECIFIED:

10 > *	> 10	: ±0.2
30 > *	> 30	: ±0.25
100 > *	> 100	: ±0.3
ANGLE		: ±3°

THIS DRAWING IS A CONTROLLED DOCUMENT.

DIMENSIONS:	TOLERANCES UNLESS OTHERWISE SPECIFIED:
MM	0 PLC ±
	1 PLC ±
	2 PLC ±
	3 PLC ±
	4 PLC ±
	ANGLES ±
MATERIAL	FINISH
SEE NOTE	SEE NOTE

					15	28	31.8	25.2	31.0
					14	26	29.8	23.2	29.0
					13	24	27.8	21.2	27.0
9-292143-2	7-292143-2	5-292143-2	3-292143-2	1-292143-2	12	22	25.8	19.2	25.0
9- -1	7- -1	5- -1	3- -1	1- -1	11	20	23.8	17.2	23.0
9- -0	7- -0	5- -0	3- -0	1- -0	10	18	21.8	15.2	21.0
8- -9	6- -9	4- -9	2- -9	-9	9	16	19.8	13.2	19.0
8- -8	6- -8	4- -8	2- -8	-8	8	14	17.8	11.2	17.0
8- -7	6- -7	4- -7	2- -7	-7	7	12	15.8	9.2	15.0
8- -6	6- -6	4- -6	2- -6	-6	6	10	13.8	7.2	13.0
8- -5	6- -5	4- -5	2- -5	-5	5	8	11.8	5.2	11.0
8- -4	6- -4	4- -4	2- -4	-4	4	6	9.8	3.2	9.0
8- -3	6- -3	4- -3	2- -3	-3	3	4	7.8	—	7.0
8-292143-2	6-292143-2	4-292143-2	2-292143-2	292143-2	2	2	5.8	—	5.0
RED	BLACK	YELLOW	BLUE	NATURAL	Pos.	A	B	C	D

PART NO.	
108-60016	
NAME: POST HEADER ASS'Y HORIZONTAL TYPE (AMP CT CONNECTOR 2mm PITCH)	
SIZE	CAGE CODE
A3	00779
DRAWING NO	292143
SCALE	5:1
SHEET	1 OF 1
REV	0