

POWER MODULES

IRK.26, .41, .56, .71, .91 SERIES

High Voltage Thyristor/Diode and Thyristor/Thyristor

FEATURES

- ⊕ *Electrically isolated base plate.*
- ⊕ *3500 V_{RMS} isolating voltage.*
- ⊕ *Simplified mechanical designs, rapid assembly.*
- ⊕ *Auxiliary cathode terminals for wiring convenience.*
- ⊕ *High surge capability.*
- ⊕ *Wide choice of circuit configurations.*
- ⊕ *Large creepage distances.*

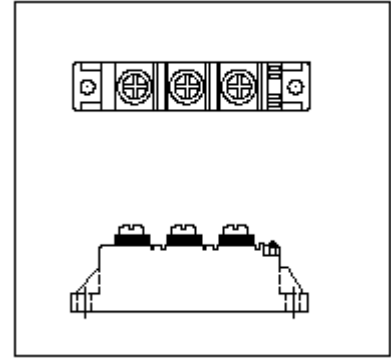

DESCRIPTION

These IRK series of Power Modules use power diodes and thyristors in a variety of circuit configurations. The semiconductor chips are electrically isolated from the metal base, allowing common heatsinks and compact assemblies to be built. They can be interconnected to form single phase or three phase bridges or AC controllers. These modules are intended for general purpose applications such as regulated power supplies, lighting circuits and temperature and motor speed control circuits.

MAJOR RATINGS & CHARACTERISTICS

Parameters	IRK.26	IRK.41	IRK.56	IRK.71	IRK.91	Units
$I_{T(AV)}$ or $I_{F(AV)}$ @ 85°C	27	45	60	75	95	A
$I_{O(RMS)}$ (*)	60	100	135	165	210	A
I_{TSM} @ 50 Hz	400	850	1310	1665	1785	A
I^2t @ 50 Hz	800	3610	8500	13860	15910	A ² s
$I^2\sqrt{t}$	8000	36100	85000	138600	159100	A ² √s
V_{RRM} range	400V - 1600V					V
T_{STG}	-40 to 125					°C
T_J	-40 to 125					°C

(*) As A.c. Switch

POWER MODULES

IRK.26, .41, .56, .71, .91 SERIES

ELECTRICAL SPECIFICATION VOLTAGE RATINGS

Type Number	Voltage Code	V_{RRM} / V_{DRM} , max. repetitive peak reverse and off-state blocking voltage V	V_{RSM} , max. non-repetitive peak reverse voltage V	I_{DRM} / I_{RRM} max. @ 125°C mA
	04	400	500	20
IRK.26/41/56/71/91	06	600	700	20
	08	800	900	20
	10	1000	1100	20
	12	1200	1300	20
	14	1400	1500	20
	16	1600	1700	20

ON-STATE CONDUCTION

Parameter	IRK.26	IRK.41	IRK.56	IRK.71	IRK.91	Units	Conditions		
$I_{T(AV)}$ $I_{F(AV)}$	27	45	60	75	95	A	180°C conduction, half sine wave $T_C = 85^\circ\text{C}$		
$I_{O(RMS)}$	60	100	135	165	210	A	As AC switch		
I_{TSM} or I_{FSM}	Max. peak one cycle non-repetitive on-state or forward current	400	850	1310	1665	1785	A	t = 10ms No voltage reapplied Sinusoidal half wave, Initial $T_J = T_J$ max.	
		335	715	1100	1400	1500	A	t = 10ms 100% V_{RRM} reapplied	
		470	940	1450	1850	2000	A	t = 10ms $T_J = 25^\circ\text{C}$ No voltage reapplied	
I^2t	Maximum I^2t for fusing	800	3610	8500	13860	15910	A ² s	t = 10ms No voltage reapplied Initial $T_J = T_J$ max.	
		560	2560	6050	9800	11250	A ² s	t = 10ms 100% V_{RRM} reapplied	
		1100	4420	10050	17110	20000	A ² s	t = 10 ms $T_J = 25^\circ\text{C}$ No voltage reapplied	
$I^2\sqrt{t}$	Maximum $I^2\sqrt{t}$ for fusing (1)	8000	36100	85000	138600	159100	A ² s	t = 0.1 to 10ms. No voltage reapplied.	
$V_{T(TO)}$	Max. value of threshold voltage (2)	0.92	0.88	0.85	0.82	0.80	V	Low level (3)	$T_J = T_J$ max. (4)
		0.95	0.91	0.88	0.85	0.85	V	High level	
r_t	Max. value of on-state slope resistance (2)	12.11	5.90	3.53	3.00	2.40	mΩ	Low level (3)	$T_J = T_J$ max. (4)
		11.82	5.74	3.41	2.90	2.25	mΩ	High level	
V_{TM}	Max. peak on-state or	1.95	1.81	1.54	1.59	1.58	V	$I_{TM} = \pi \times I_{T(AV)}$	$T_J = 25^\circ\text{C}$ 180°conduction
V_{FM}	forward voltage	1.95	1.81	1.54	1.59	1.58	V	$I_{FM} = \pi \times I_{F(AV)}$	
di/dt	Max. non-repetitive rate of rise of turned on current	150	150	150	150	150	A/μs	$T_J = 25^\circ\text{C}$, from 0.67 V_{DRM} $I_{TM} = \pi \times I_{T(AV)}$, $I_g = 500\text{mA}$ $t_r < 0.5 \mu\text{s}$, $t_p > 6\mu\text{s}$	
I_H	Maximum holding current	200	200	200	200	200	mA	$T_J = 25^\circ\text{C}$, anode supply = 6V, resistive load, gate open circuit	
I_L	Max. latching current	400	400	400	400	400	mA	$T_J = 25^\circ\text{C}$, anode supply = 6V, resistive load	

(1) I^2t for time $t_x = I^2\sqrt{t} \times \sqrt{t_x}$
 (3) $16.7\% \times \pi \times I_{AV} < I < \pi \times I_{AV}$

(2) Average power = $V_{T(TO)} \times I_{T(AV)} + r_t \times (I_{T(RMS)})^2$
 (4) $\pi \times I_{AV} < I < 20 \times \pi \times I_{AV}$

POWER MODULES

IRK.26, .41, .56, .71, .91 SERIES

ELECTRICAL SPECIFICATION TRIGGERING

	Parameter	IRK.26	IRK.41	IRK.56	IRK.71	IRK.91	Units	Conditions	
P_{GM}	Max. peak gate power	10	10	10	12	12	W		
$P_{G(AV)}$	Max. average gate power	2.5	2.5	2.5	3.0	3.0	W		
I_{GM}	Max. peak gate current	2.5	2.5	2.5	3.0	3.0	A		
$-V_{GM}$	Max. peak negative gate voltage	10	10	10	10	10	V		
V_{GT}	Max. gate voltage required to trigger	4.0	4.0	4.0	4.0	4.0	V	$T_J = -40^\circ\text{C}$	Anode supply = 6V resistive load
		2.5	2.5	2.5	2.5	2.5	V	$T_J = 25^\circ\text{C}$	
		1.7	1.7	1.7	1.7	1.7	V	$T_J = 125^\circ\text{C}$	
I_{GT}	Max. gate current required to trigger	170	270	270	270	270	mA	$T_J = -40^\circ\text{C}$	Anode supply = 6V resistive load
		150	150	150	150	150	mA	$T_J = 25^\circ\text{C}$	
		80	80	80	80	80	mA	$T_J = 125^\circ\text{C}$	
V_{GD}	Max. gate voltage that will not trigger	0.25	0.25	0.25	0.25	0.25	V	$T_J = 125^\circ\text{C}$ rated V_{DRM} applied	
I_{GD}	Max. gate current that will not trigger	6.0	6.0	6.0	6.0	6.0	mA	$T_J = 125^\circ\text{C}$ rated V_{DRM} applied	

BLOCKING

I_{RRM} I_{DRM}	Max. peak reverse and off-state leakage current at V_{RRM} , V_{DRM}	15	15	15	15	15	mA	$T_J = 125^\circ\text{C}$, gate open circuit
V_{INS}	RMS isolation voltage	3500	3500	3500	3500	3500	V	50 Hz circuit to base, all terminal shorted, $t = 1\text{s}$
dv/dt	Max. critical rate of rise of off-state Voltage	1000	1000	1000	1000	1000	V/ μ	$T_J = 125^\circ\text{C}$ linear to $0.67V_{DRM}$, gate open circuit

THERMAL AND MECHANICAL SPECIFICATIONS

	Parameter	IRK.26	IRK.41	IRK.56	IRK.71	IRK.91	Units	Conditions	
T_J	Junction operating temperature range	-40 to 125						$^\circ\text{C}$	
T_{stg}	Storage temp. range	-40 to 125						$^\circ\text{C}$	
R_{thJC}	Max. internal thermal resistance, junction to case	0.31	0.23	0.20	0.165	0.135	K/W	Per module, D.C. operation	
R_{thCS}	Max. thermal resistance case to heatsink	0.1						K/W	Mounting surface flat, smooth and greased (per module)
T	Mounting torque $\pm 10\%$ Module to heatsink	5						Nm	A mounting compound is recommended and the torque should be rechecked after a period of 3 hours to allow for the spread of the compound.
	Busbar to module	3						Nm	
Wt	Approximate weight	75						g	
	Case style	To-240AA							

POWER MODULES

IRK.26, .41, .56, .71, .91 SERIES

OUTLINE DIAGRAM

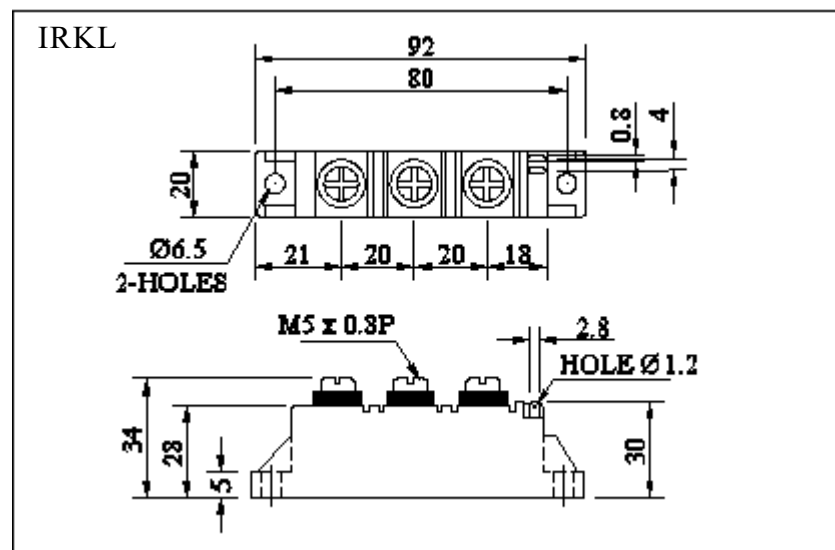
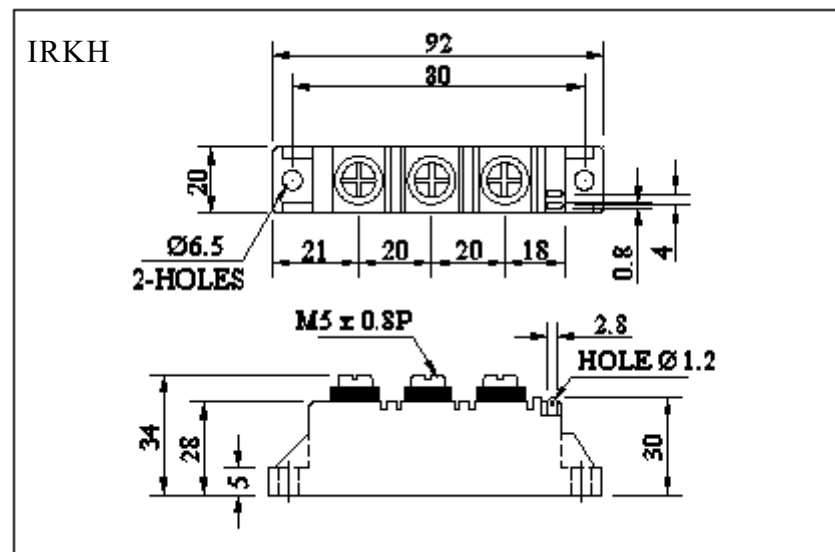
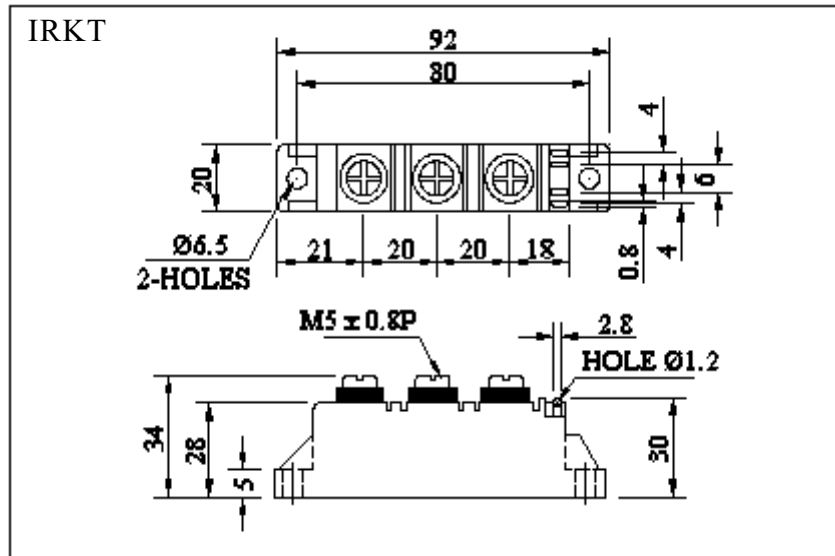

POWER MODULES

IRK.26 Series

Circuit Configuration Table

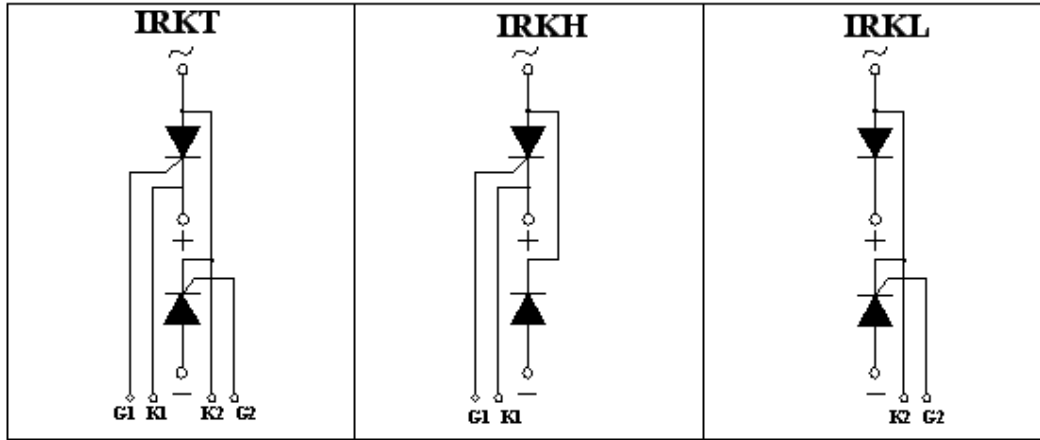

Ordering Information Table

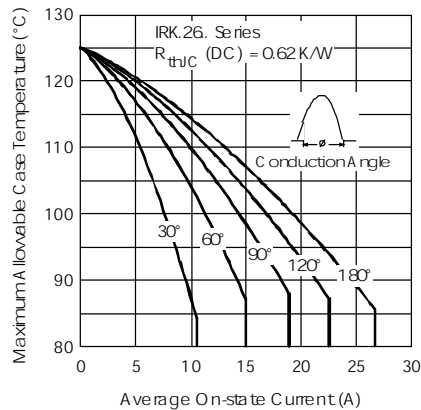
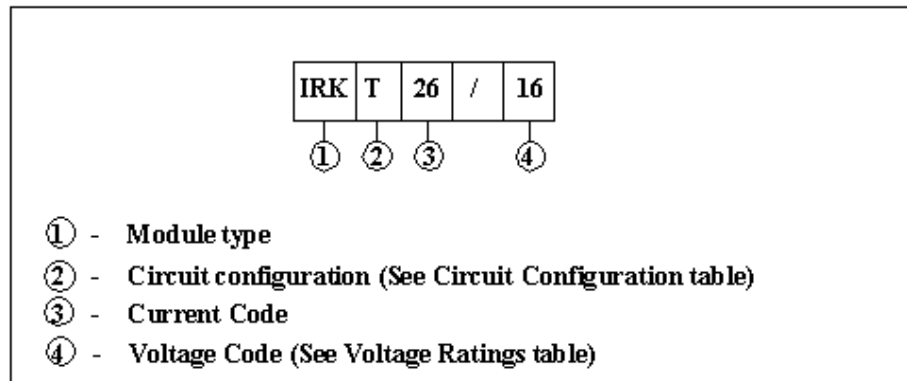

Fig. 1 - Current Ratings Characteristics

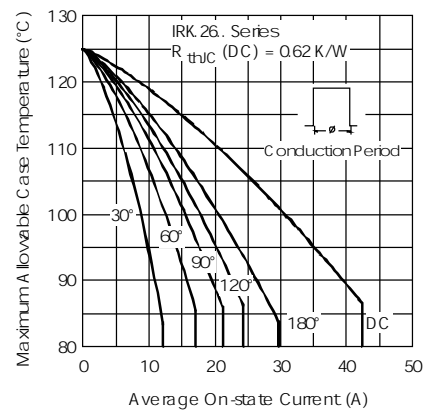

Fig. 2 - Current Ratings Characteristics

POWER MODULES

IRK.26 Series

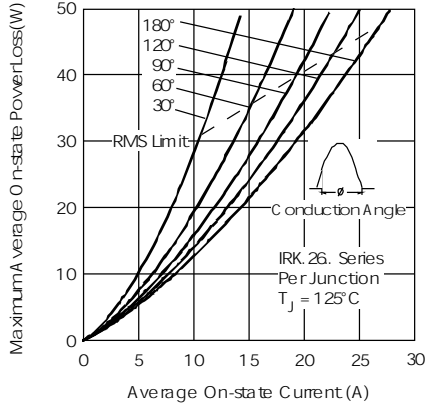

Fig. 3 - On-state Power Loss Characteristics

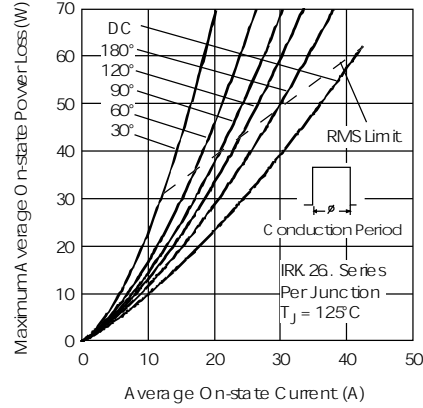

Fig. 4 - On-state Power Loss Characteristics

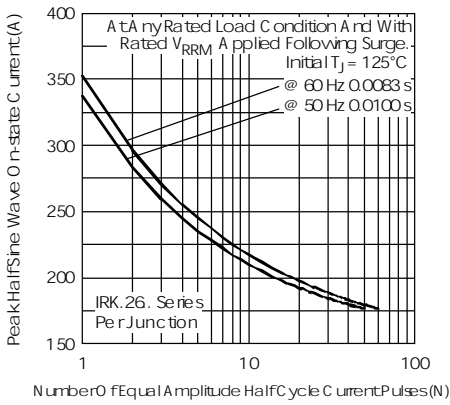

Fig. 5 - Maximum Non-Repetitive Surge Current

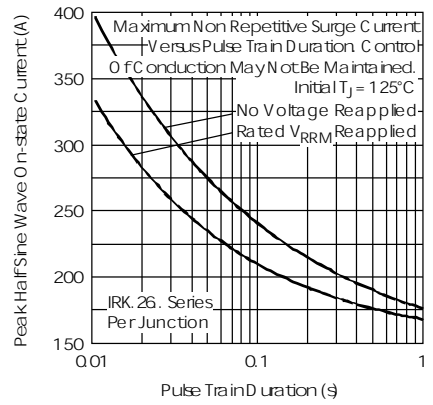

Fig. 6 - Maximum Non-Repetitive Surge Current

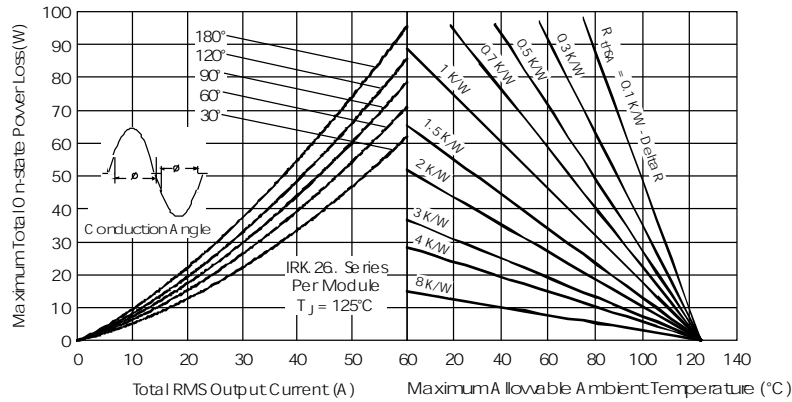

Fig. 7 - On-state Power Loss Characteristics

POWER MODULES

IRK.26 Series

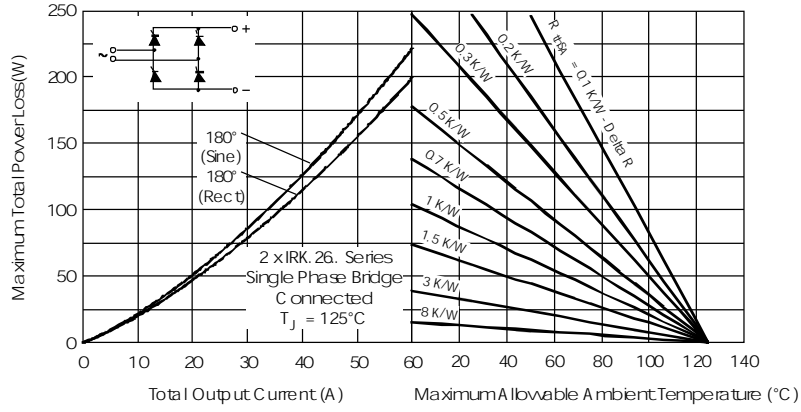

Fig. 8 - On-state Power Loss Characteristics

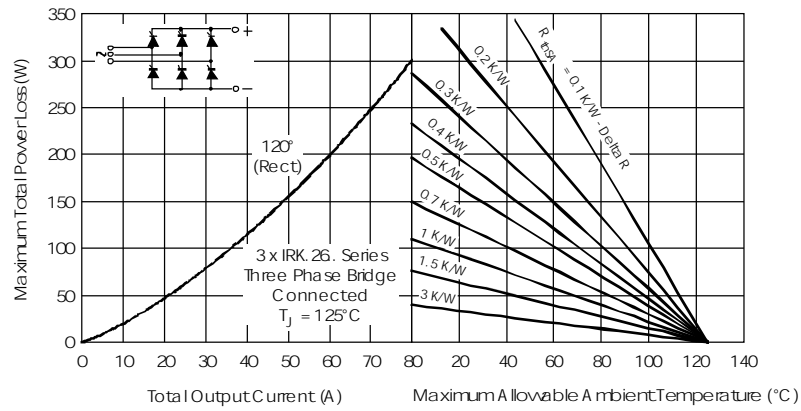

Fig. 9 - On-state Power Loss Characteristics

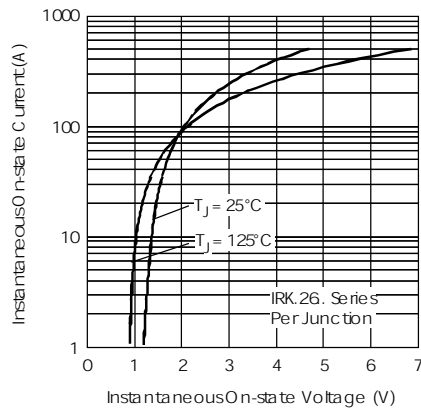

Fig. 10 - On-state Voltage Drop Characteristics

POWER MODULES

IRK.26 Series

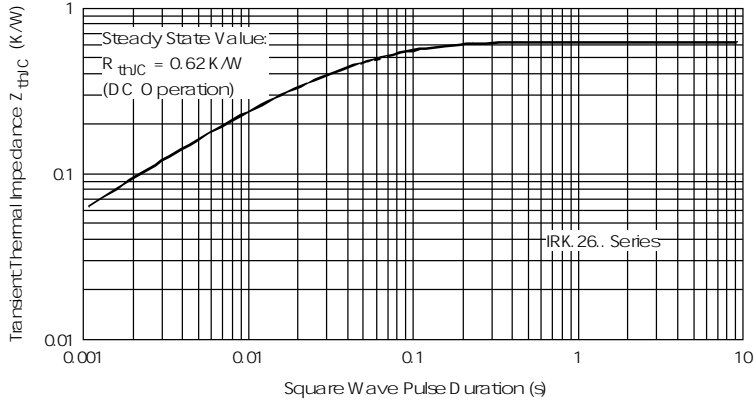

Fig. 11 - Thermal Impedance Z_{thJC} Characteristics

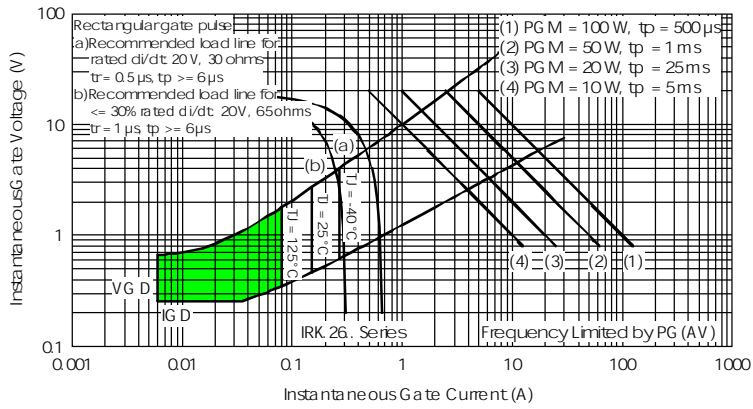
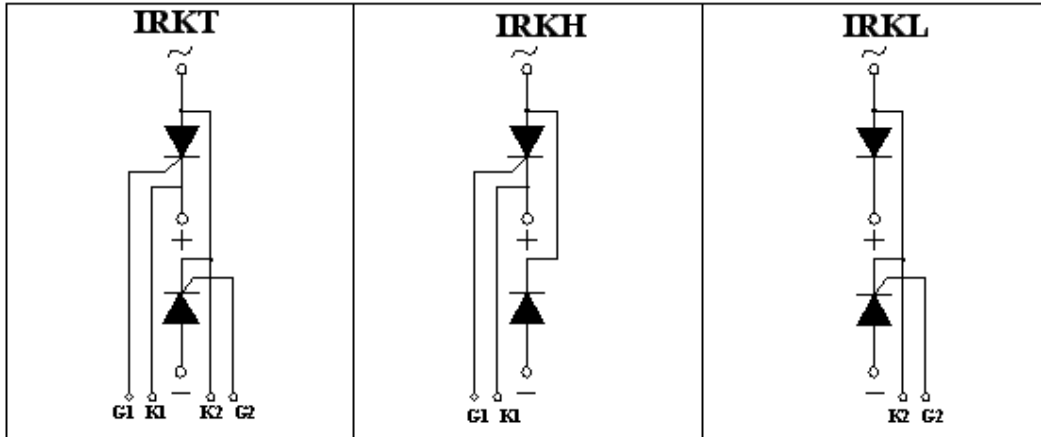

Fig. 12- Gate Characteristics

POWER MODULES

IRK.41, .56 Series

Circuit Configuration Table



Ordering Information Table

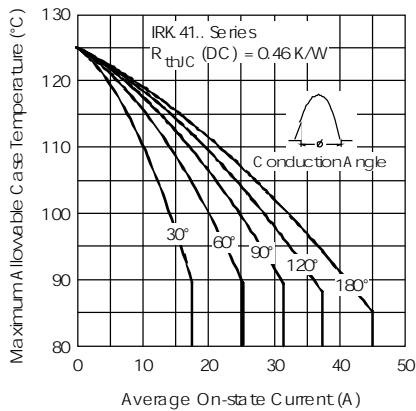
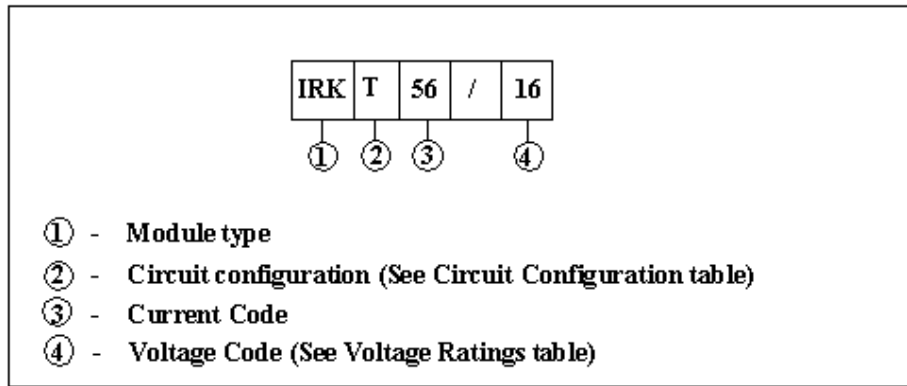

Fig. 13 - Current Ratings Characteristics

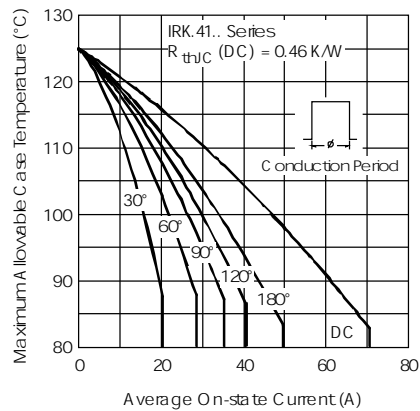

Fig. 14 - Current Ratings Characteristics

POWER MODULES

IRK.41, .56 Series

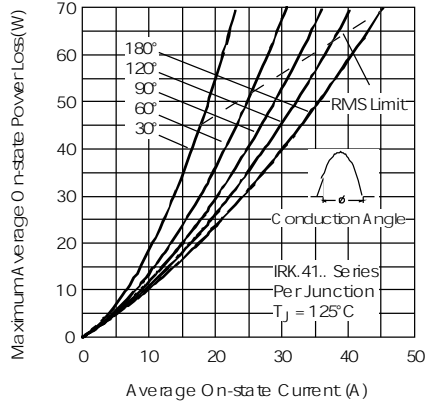

Fig. 15 - On-state Power Loss Characteristics

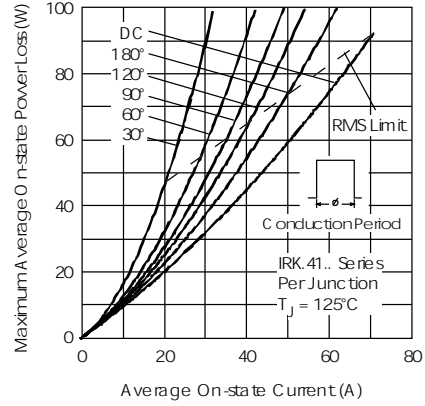

Fig. 16 - On-state Power Loss Characteristics

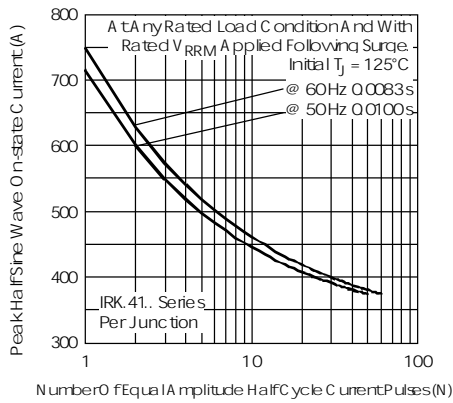

Fig. 17 - Maximum Non-Repetitive Surge Current

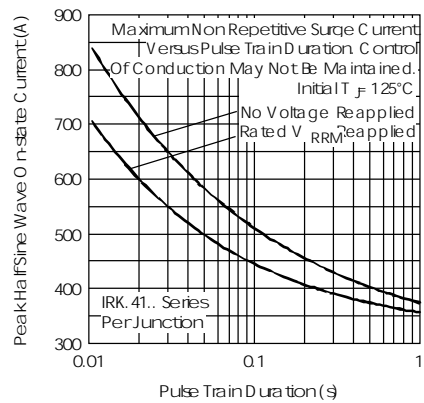

Fig. 18 - Maximum Non-Repetitive Surge Current

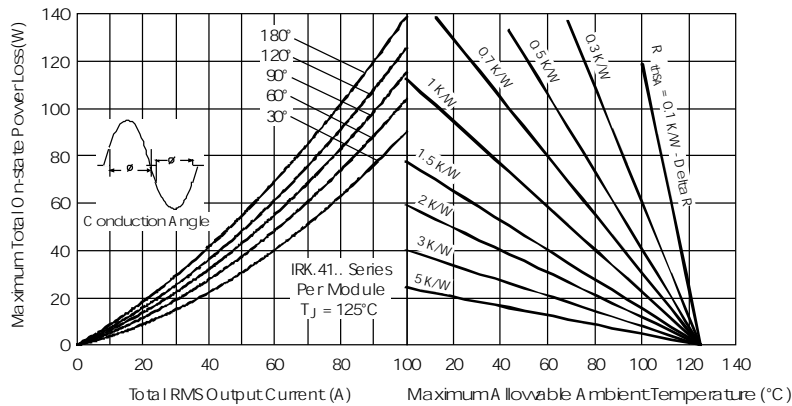

Fig. 19 - On-state Power Loss Characteristics

POWER MODULES

IRK.41, .56 Series

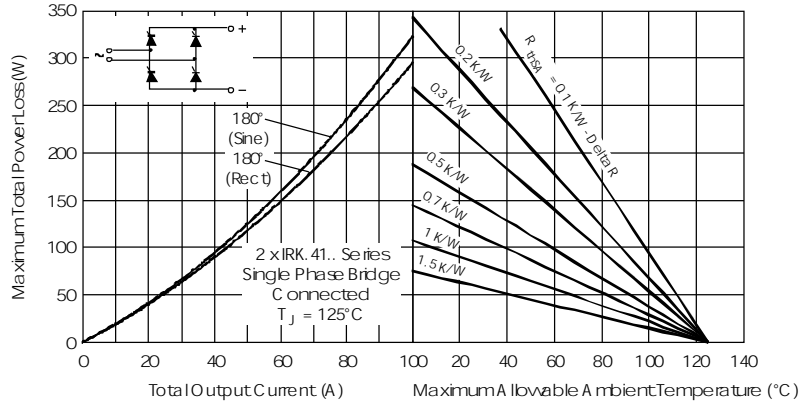

Fig. 20 - On-state Power Loss Characteristics

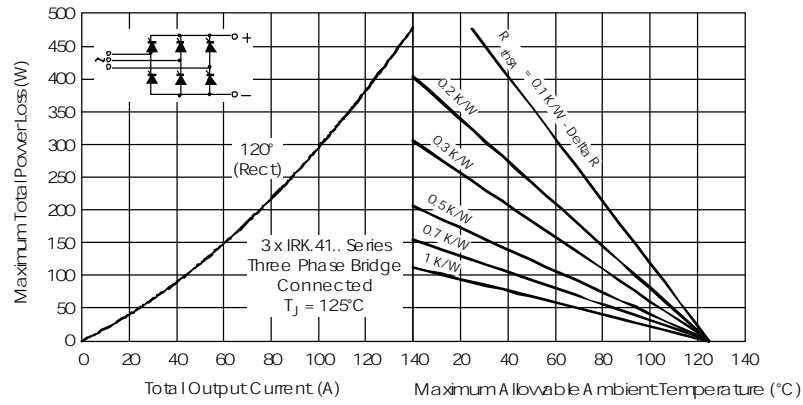

Fig. 21 - On-state Power Loss Characteristics

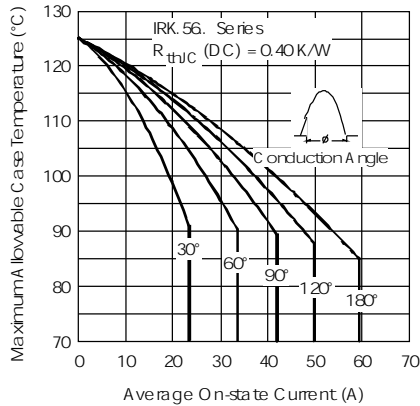

Fig. 22 - Current Ratings Characteristics

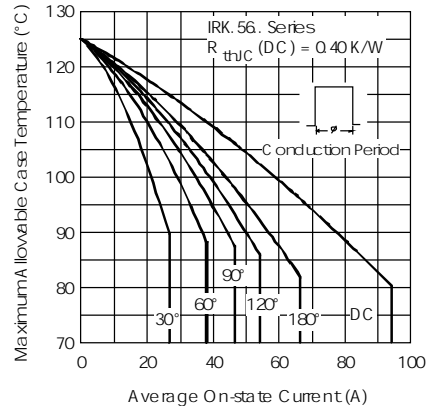

Fig. 23 - Current Ratings Characteristics

POWER MODULES

IRK.41, .56 Series

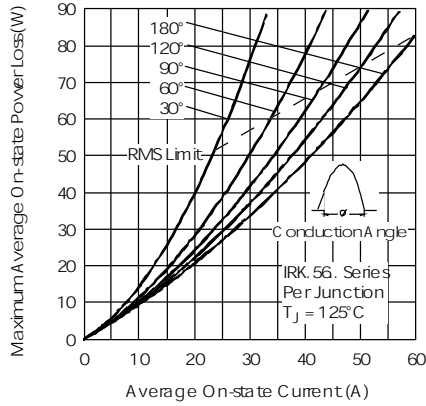

Fig. 24 - On-state Power Loss Characteristics

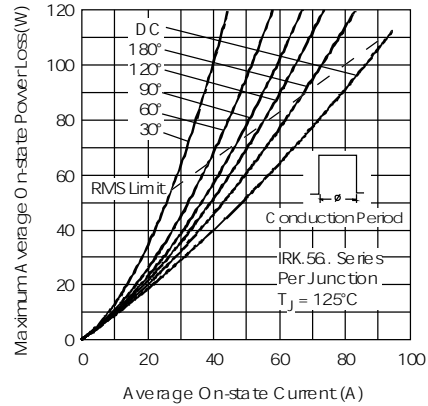

Fig. 25 - On-state Power Loss Characteristics

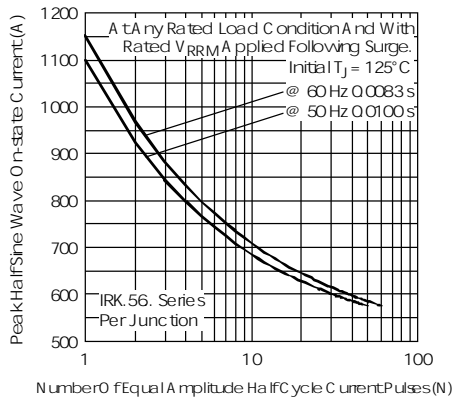

Fig. 26 - Maximum Non-Repetitive Surge Current

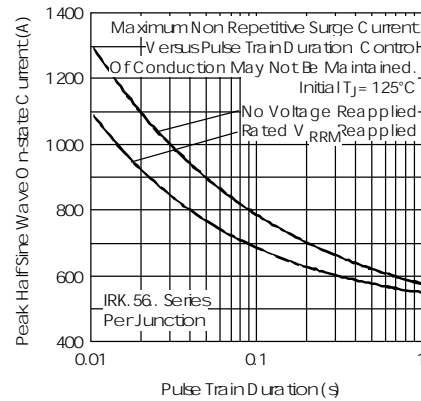

Fig. 27 - Maximum Non-Repetitive Surge Current

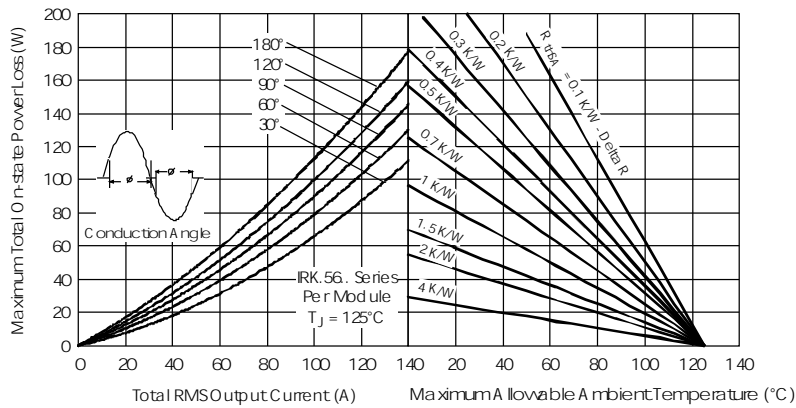

Fig. 28 - On-state Power Loss Characteristics

POWER MODULES

IRK.41, .56 Series

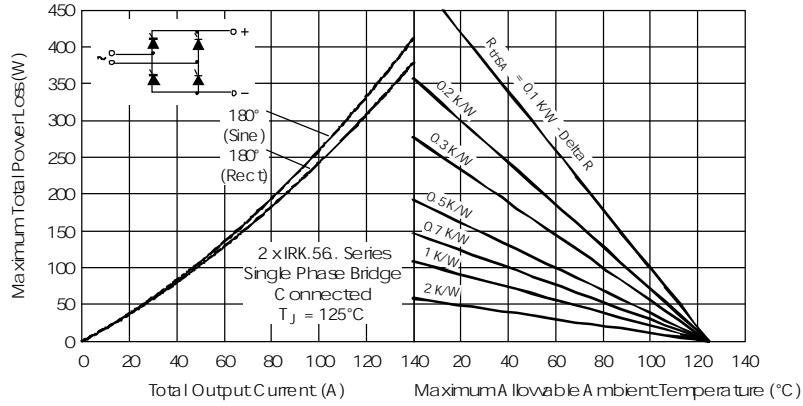

Fig. 29 - On-state Power Loss Characteristics

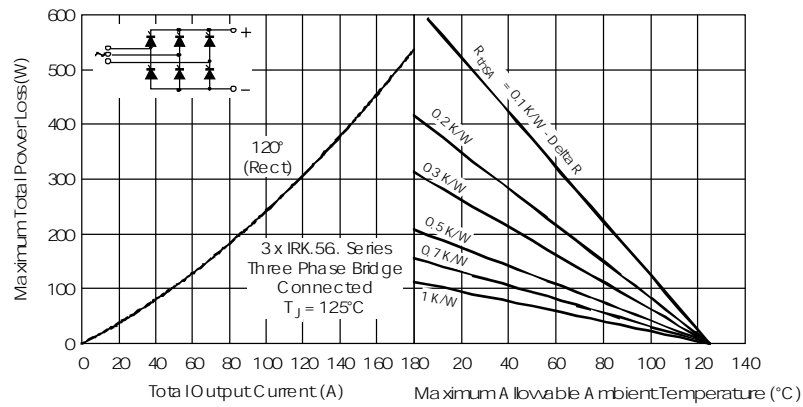

Fig. 30 - On-state Power Loss Characteristics

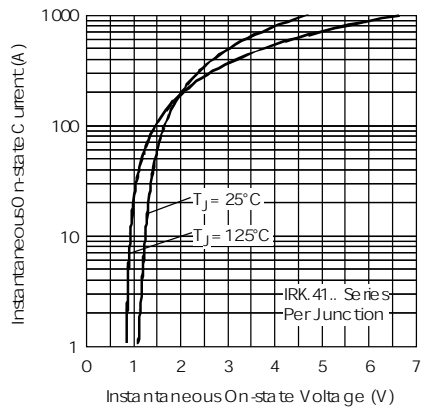

Fig. 31 - On-state Voltage Drop Characteristics

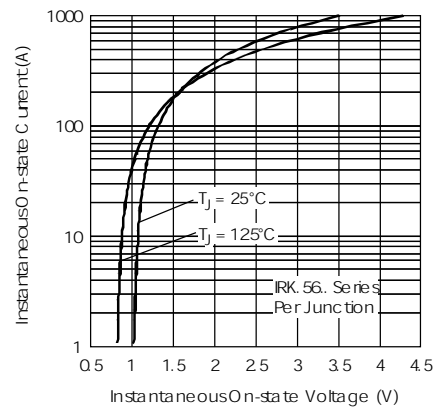

Fig. 32 - On-state Voltage Drop Characteristics

POWER MODULES

IRK.41, .56 Series

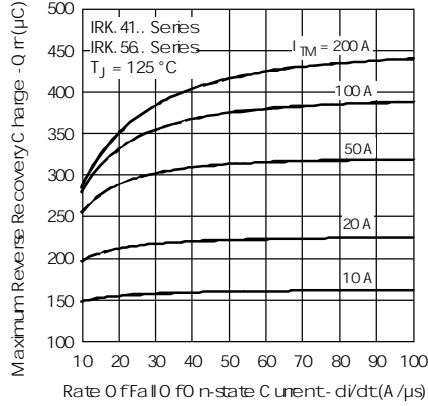

Fig. 33 - Recovery Charge Characteristics

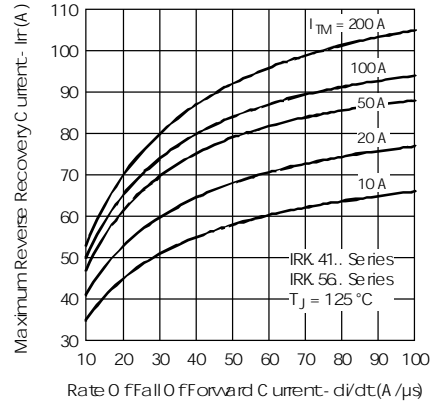

Fig. 34 - Recovery Current Characteristics

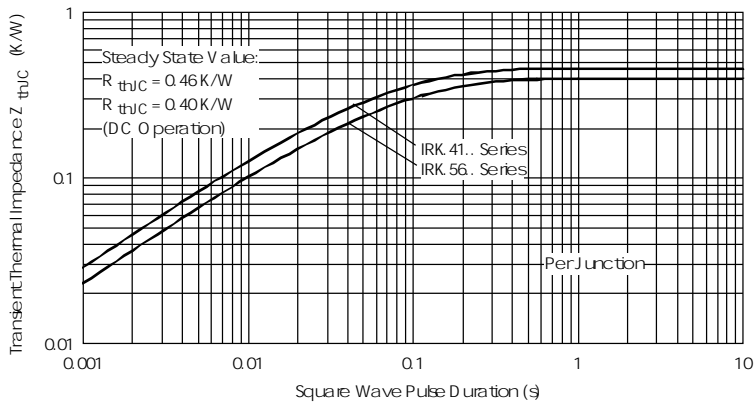

Fig. 35 - Thermal Impedance Z_{thJC} Characteristics

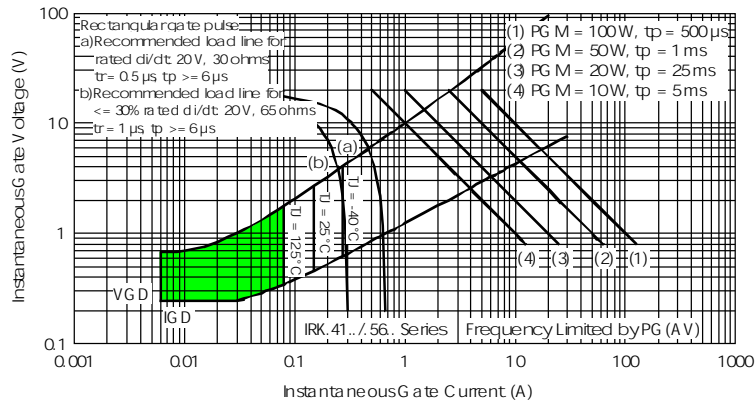
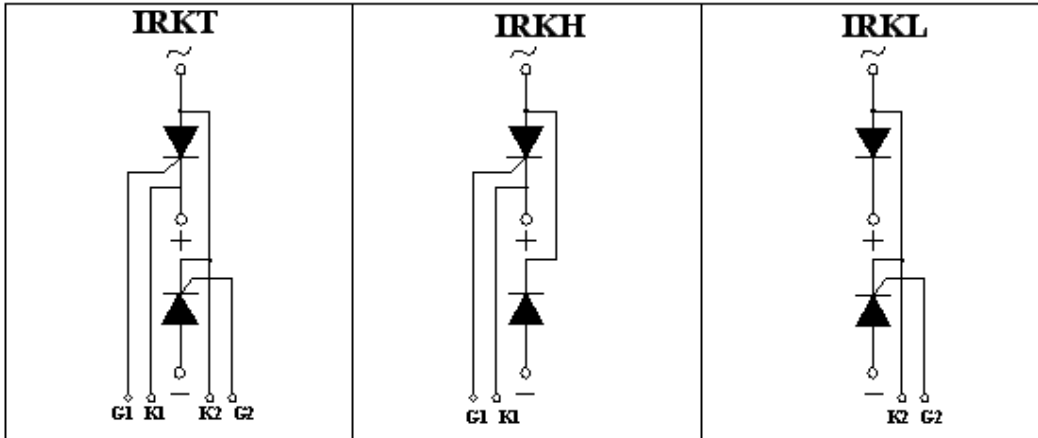

Fig. 36 - Gate Characteristics

POWER MODULES

IRK.71, .91 Series

Circuit Configuration Table



Ordering Information Table

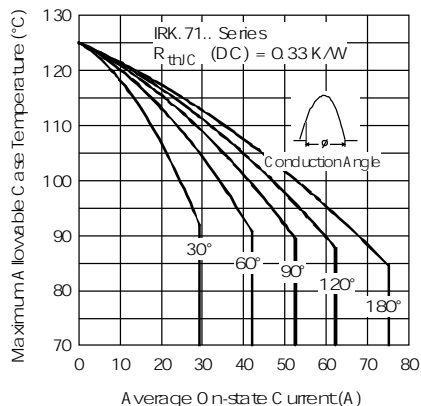
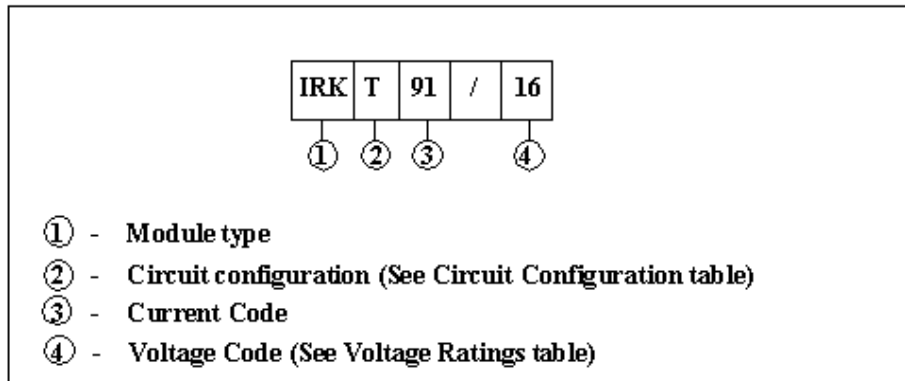

Fig. 37- Current Ratings Characteristics

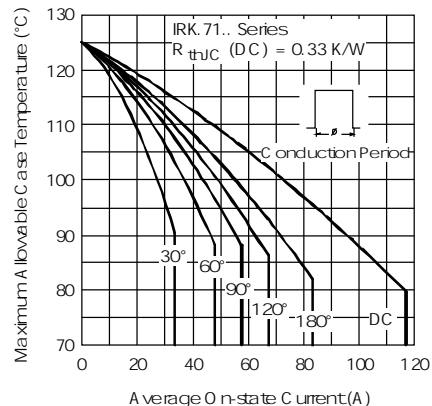

Fig. 38 - Current Ratings Characteristics

POWER MODULES

IRK.71, .91 Series

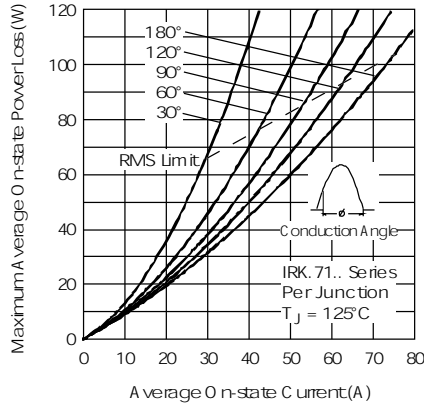

Fig. 39- On-state Power Loss Characteristics

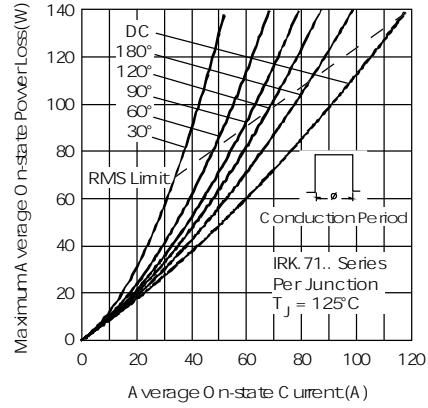

Fig.40 - On-state Power Loss Characteristics

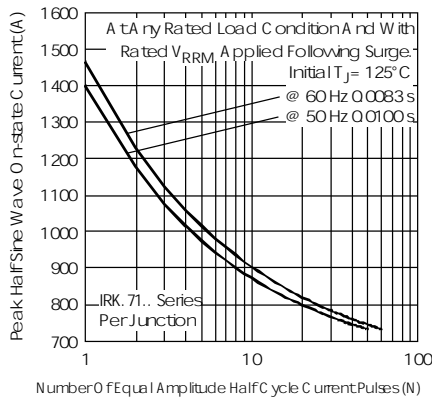

Fig. 41 - Maximum Non-Repetitive Surge Current

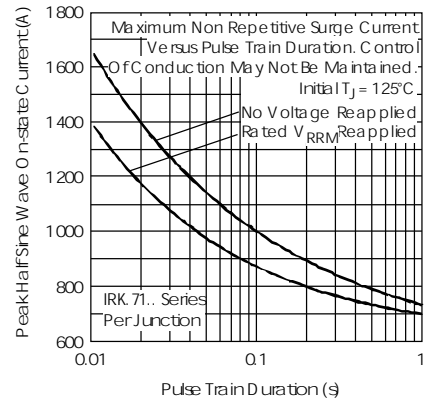

Fig. 42 - Maximum Non-Repetitive Surge Current

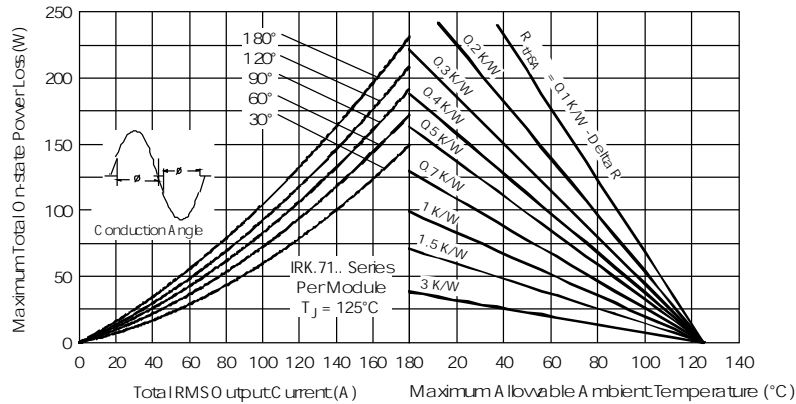

Fig. 43 - On-state Power Loss Characteristics

POWER MODULES

IRK.71, .91 Series

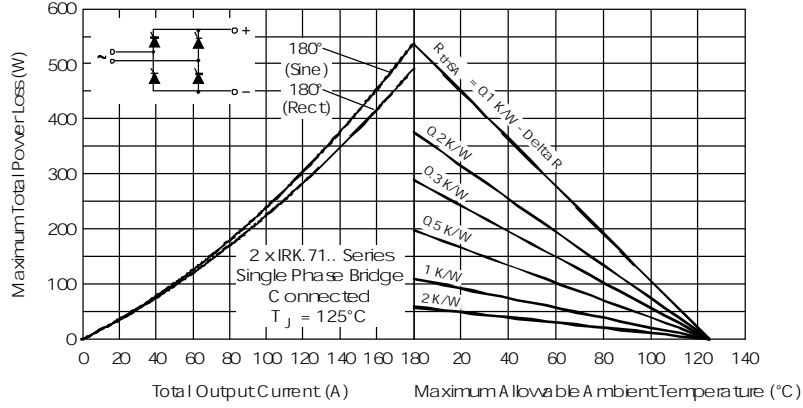

Fig. 44 - On-state Power Loss Characteristics

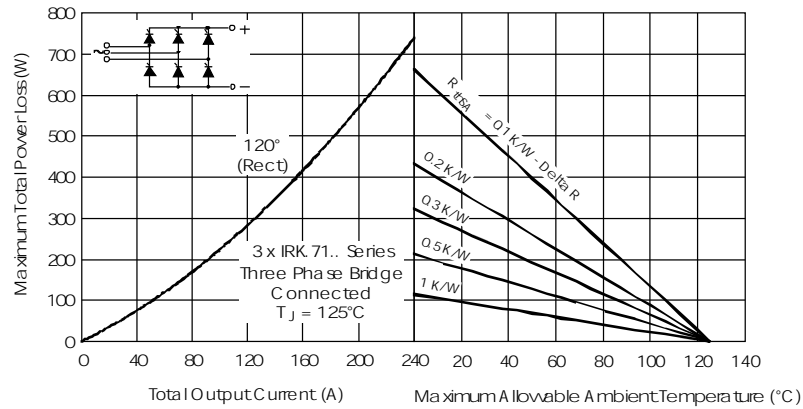

Fig. 45 - On-state Power Loss Characteristics

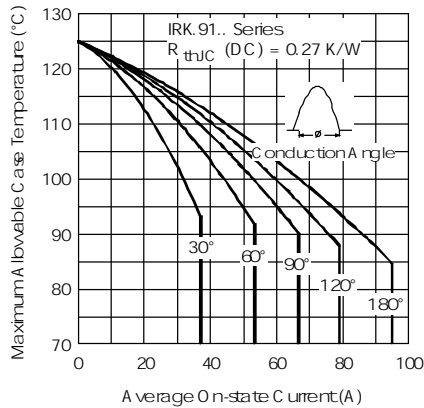

Fig. 46 - Current Ratings Characteristics

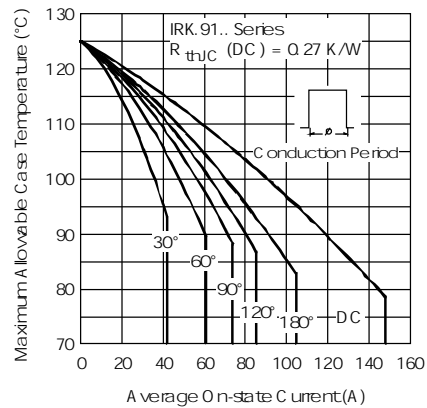

Fig. 47 - Current Ratings Characteristics

POWER MODULES

IRK.71, .91 Series

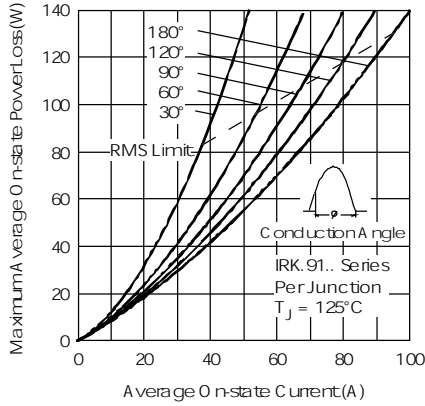

Fig. 48 - On-state Power Loss Characteristics

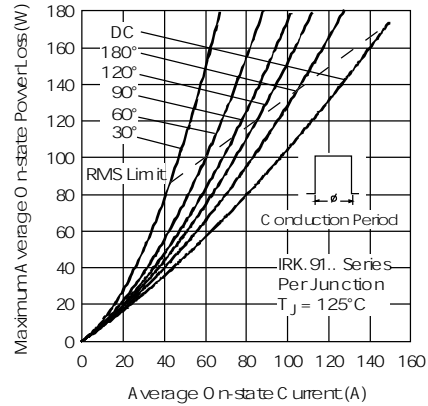

Fig. 49 - On-state Power Loss Characteristics

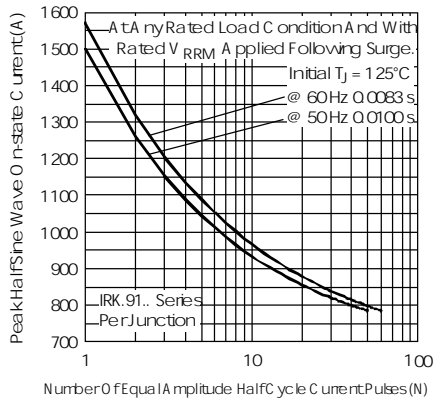

Fig. 50 - Maximum Non-Repetitive Surge Current

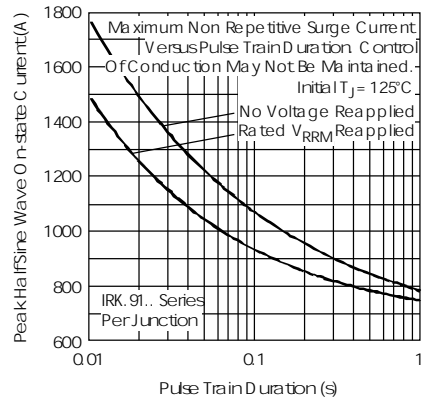

Fig. 51 - Maximum Non-Repetitive Surge Current

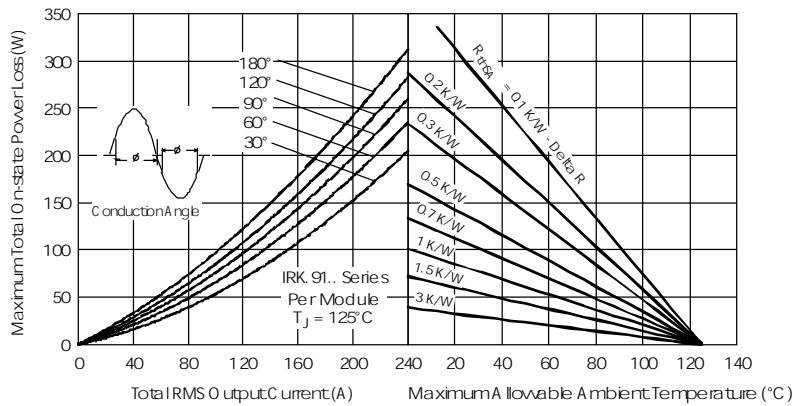

Fig. 52 - On-state Power Loss Characteristics

POWER MODULES

IRK.71, .91 Series

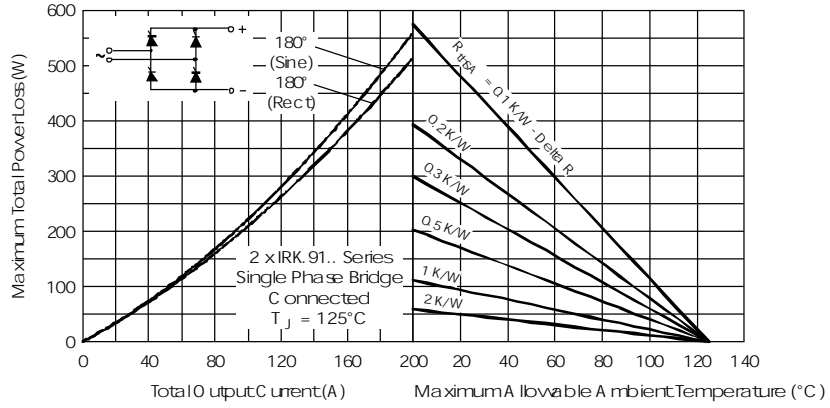

Fig. 53 - On-state Power Loss Characteristics

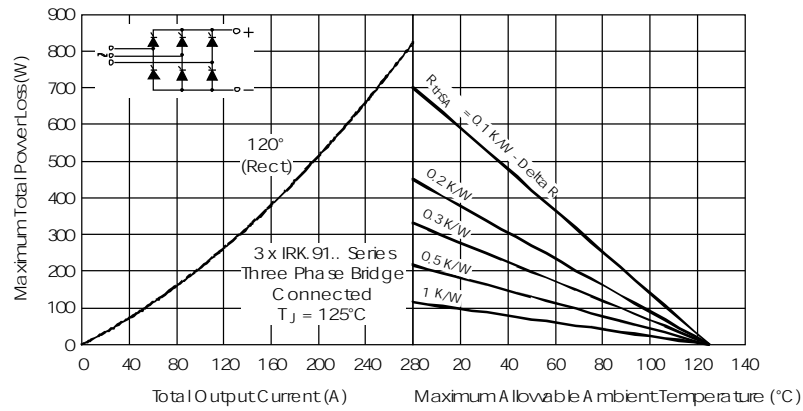

Fig. 54 - On-state Power Loss Characteristics

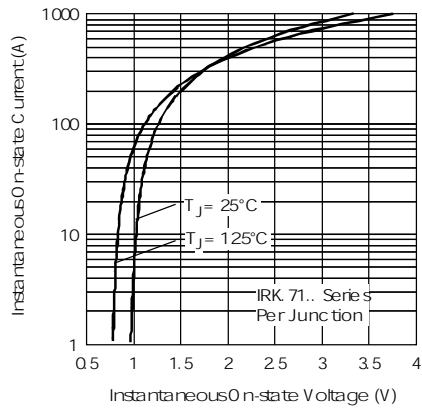

Fig. 55 - On-state Voltage Drop Characteristics

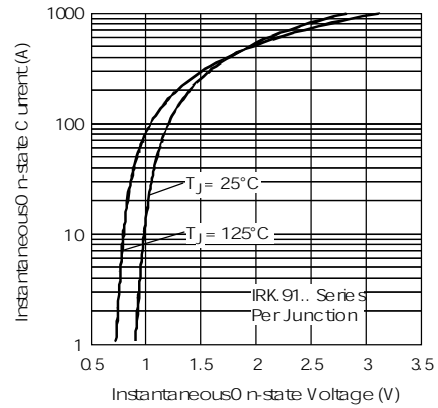

Fig. 56 - On-state Voltage Drop Characteristics

POWER MODULES

IRK.71, .91 Series

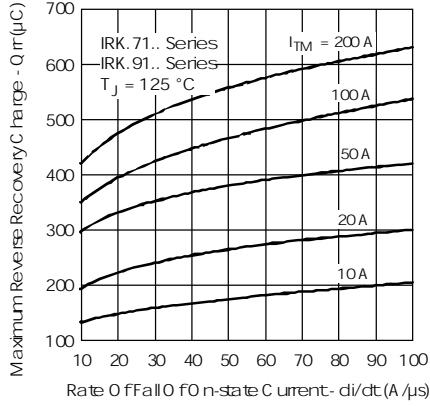

Fig. 57 - Recovery Charge Characteristics

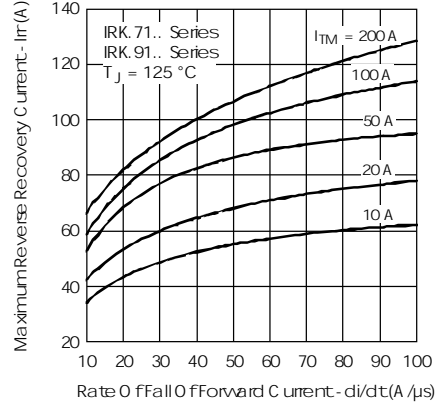

Fig. 58 - Recovery Current Characteristics

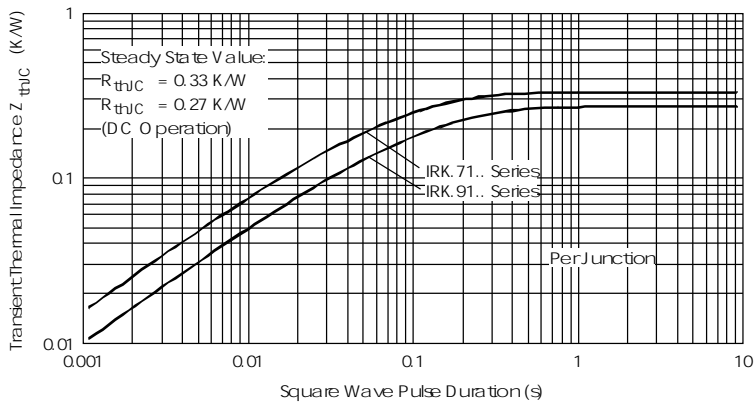

Fig. 59 - Thermal Impedance Z_{thJC} Characteristics

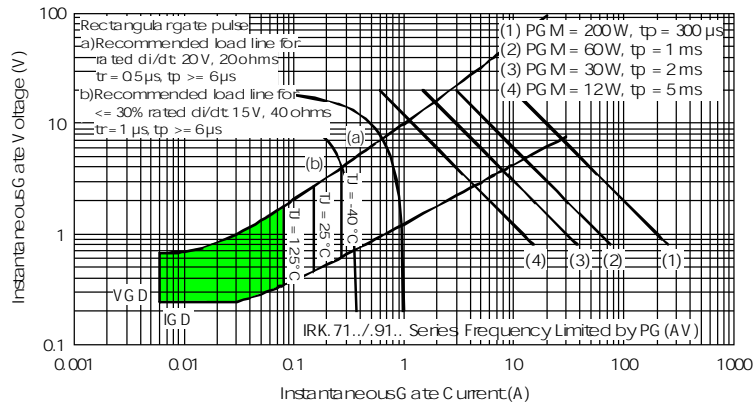

Fig. 60 - Gate Characteristics

Last Update : Apr 2006