

# Monolithic Integrated Circuit

Applications: AM-/FM-/IF- and Audio-Amplifier

## Features:

- Large supply voltage range  
 $V_S = 3 \dots 15 \text{ V}$
- High AM-Sensitivity
- Limiting threshold voltage  $V_I = 50 \mu\text{V}$
- Audio output power  $P_o = 1 \text{ W}$
- AM-Oscillator for LW, MW and SW
- Connection possibility for an external capacitor to suppress hum voltage
- AM-FM switching without high frequency voltages

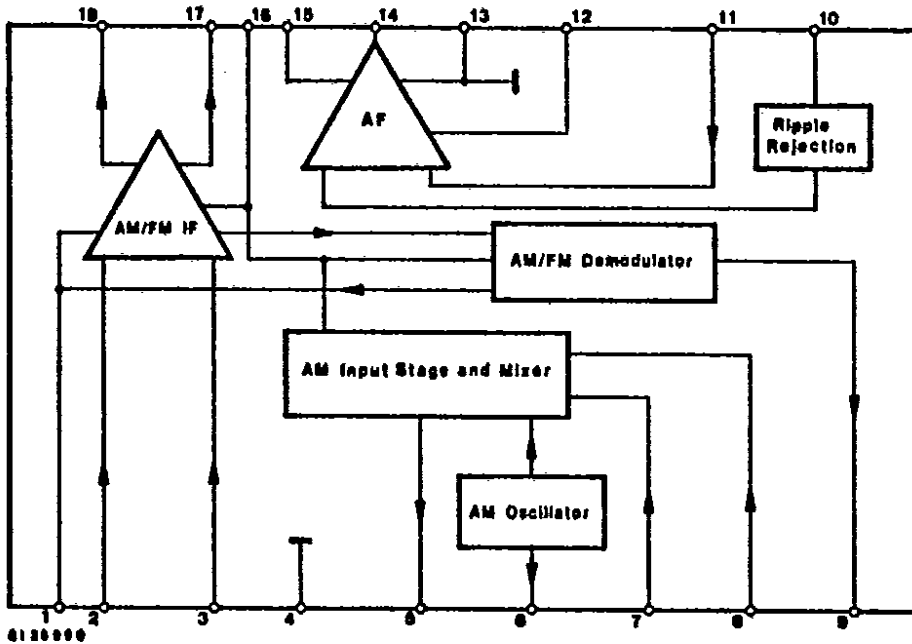

- 1 AGC/AFC-Voltage
- 2 IF-Decoupling
- 3 IF-Input
- 4 RF-Ground
- 5 AM-Mixer output
- 6 AM-Oscillator circuit
- 7 AM-Input
- 8 AM-Decoupling
- 9 Demodulator-Output
- 10 Ripple rejection
- 11 Audio-Input
- 12 Audio-Feedback
- 13 Audio-Ground
- 14 Audio-Output
- 15 +  $V_S$
- 16 +  $V_S$
- 17 Demodulator circuit
- 18 Demodulator circuit

Fig. 1 Block diagram and pin connections

## Description

The integrated circuit U 418 B includes, with exception of the FM front end, a complete AM-/FM-radio-circuit with audio power amplifier.

To avoid interference between AF- and RF-section, there are available two leads for supply voltages. An improvement in hum voltage suppression can be attained by using an external capacitor.

## Absolute maximum ratings

Reference points Pin 4, 13, unless otherwise specified

Supply voltage range	Pin 15/16	$V_S$	3...15	V
Power dissipation		$P_{tot}$	600	mW
$T_{amb} = 65^\circ\text{C}$		$T_j$	150	$^\circ\text{C}$
Junction temperature		$T_{stg}$	-25...+150	$^\circ\text{C}$
Storage temperature range				

## Thermal resistance

Junction ambient	$R_{thJA}$	Min.	Typ.	Max.	
				100	K/W



**Electrical characteristics** Min. Typ. Max.  
 $V_S = 9\text{ V}$ , reference points Pin 4 and 13,  $T_{amb} = 25^\circ\text{C}$ , unless otherwise specified

**AF Amplifier**

$R_1 = 8\ \Omega$ ,  $d = 10\%$ , Fig. 3, 5

Output power	Pin 14	$P_o$	0.9	1	W	
Supply voltage rejection ratio						
$V_{hum} = 0.35\text{ V}$ , $C_1 = 47\ \mu\text{F}$						
$f_{hum} = 100\text{ Hz}$		SVR		30	dB	
Input resistance	Pin 11	$R_i$	800		k $\Omega$	
Band width (-3 dB)		B		100...80 000	Hz	
Distortion						
$P_o = 50\text{ mW}$		d		1	%	
Voltage gain, closed loop	Pin 14	$G_v$	37	40	43	dB
Output noise voltage	Pin 14	$V_{no}$			600	$\mu\text{V}$
$R_G = 0$ , $B = 22...22\ 000$						

**AM-Amplifier**

$f_i = 1\text{ MHz}$ ,  $f_{IF} = 455\text{ kHz}$ ,  $f_{mod} = 1\text{ kHz}$ ,  $m = 0.3$

Supply quiescent current	Pin 15/16	$I_{SB}$	8	19	mA
Output quiescent voltage	Pin 14	$V_{OB}$	3.9	4.7	V
AGC-Quiescent voltage	Pin 1	$V_{AGCB}$	1.4	2.1	V
Regulation range					
$\Delta V_{OAF}/V_{OAF} = -10\text{ dB}$	Pin 7	$\Delta V_i$		70	dB
AF voltage at demodulator output	Pin 9	$V_{OAF}$		100	mV

**FM-IF Amplifier**

$f_{IF} = 10.7\text{ MHz}$ ,  $\Delta f = \pm 22.5\text{ kHz}$ ,  $f_{mod} = 1\text{ kHz}$

Supply quiescent current	Pin 15/16	$I_{SB}$	10	20	mA
Output quiescent voltage	Pin 14	$V_{OB}$	3.9	4.7	V
AFC-Quiescent voltage	Pin 1	$V_{AFCB}$	1.8	2.8	V
Limiting threshold (-3 dB)	Pin 3	$V_i$		50	$\mu\text{V}$
AF voltage at demodulator output	Pin 9	$V_{OAF}$		100	mV

Different dc voltages are developed at Pin 1 due to gain spread of AM-IF-amplifier. To determine the value of parallel resistance  $R_9$  at the output of the demodulator Pin 9 for  $V_S = 9\text{ V}$ , AM mode without signal, dc voltage should be selected at Pin 1.

Voltage groups designation:

Group	1	2	3
$V_1$	1.4...1.7 V	1.7...1.9 V	1.9...2.1 V
$R_9$	$\infty$	47 k $\Omega$	33 k $\Omega$

Example:

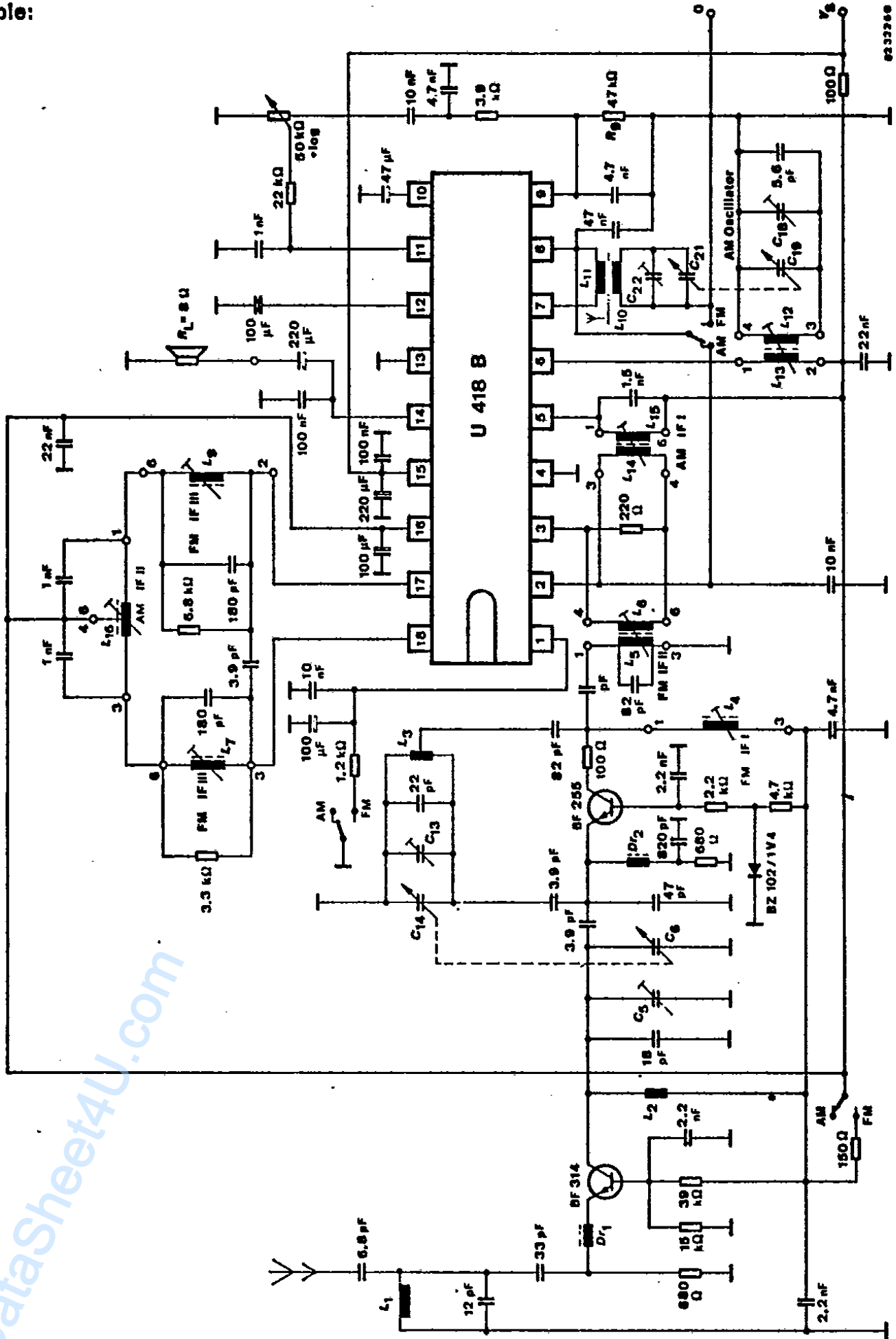
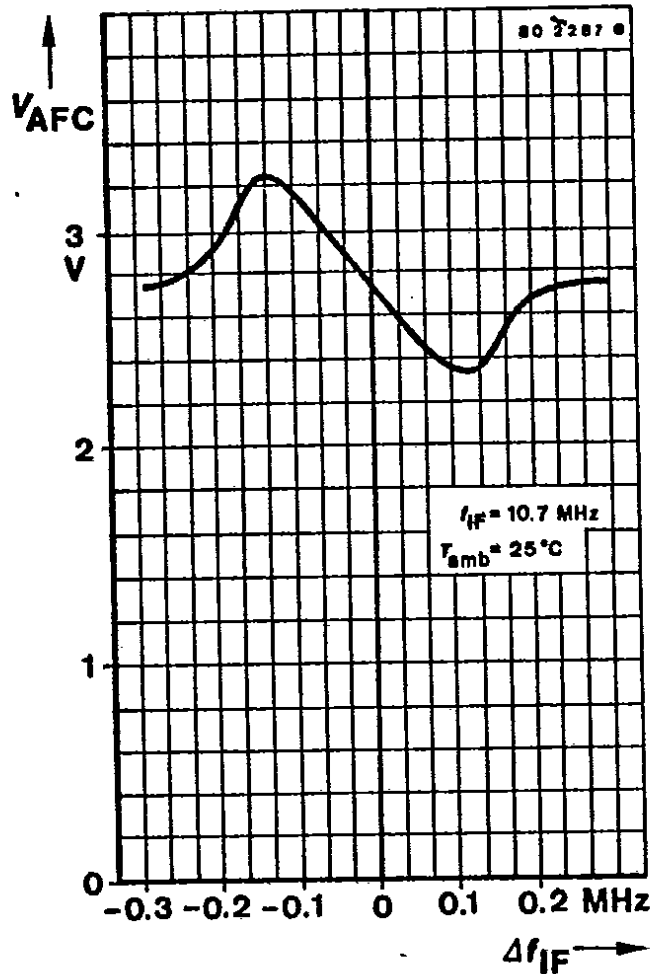
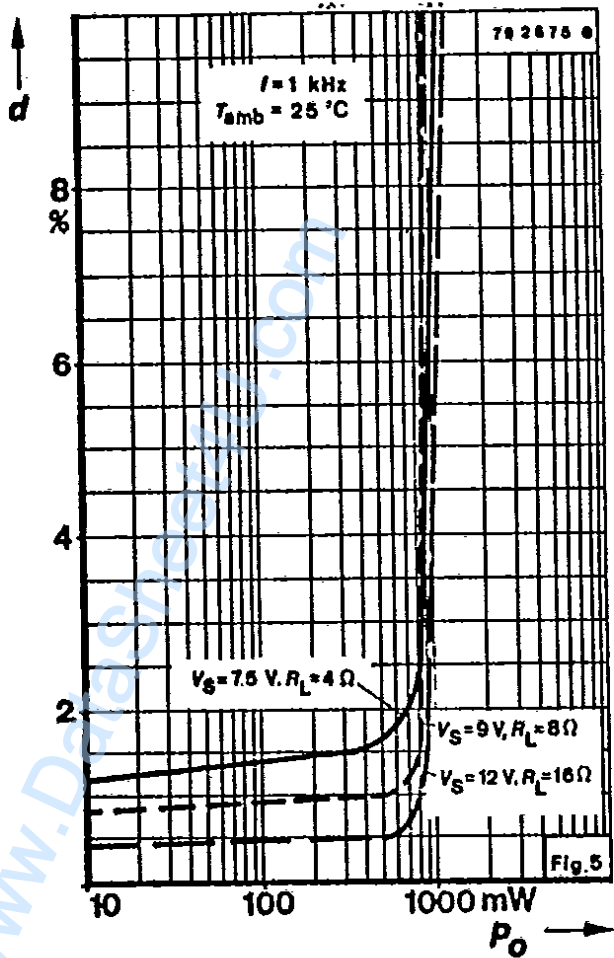
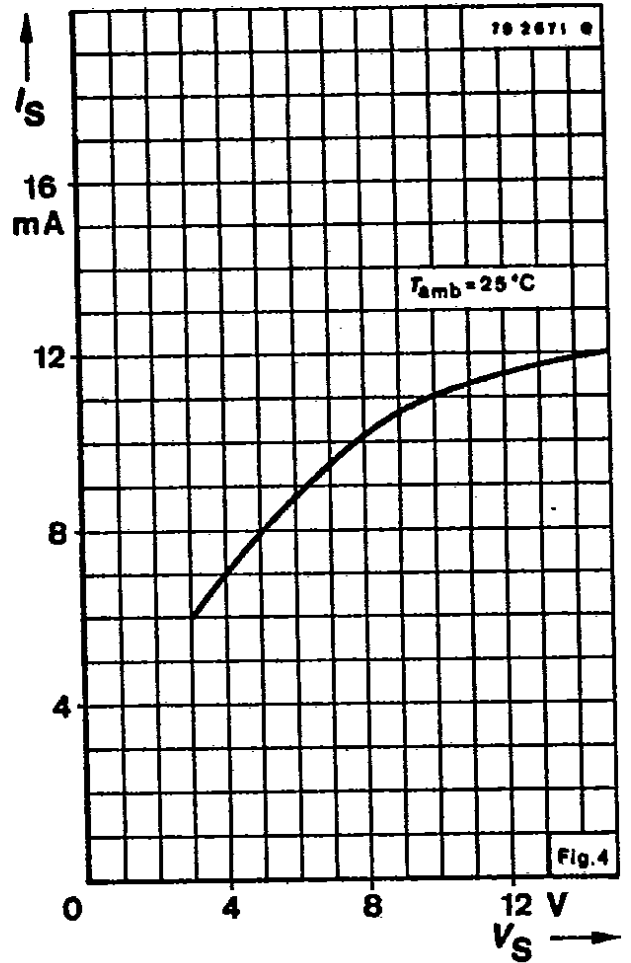
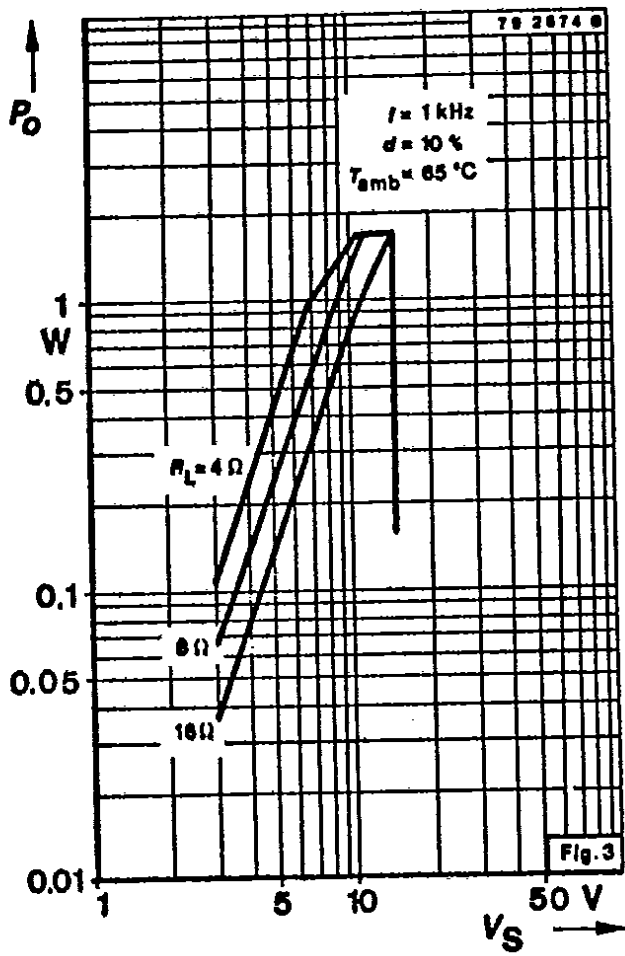
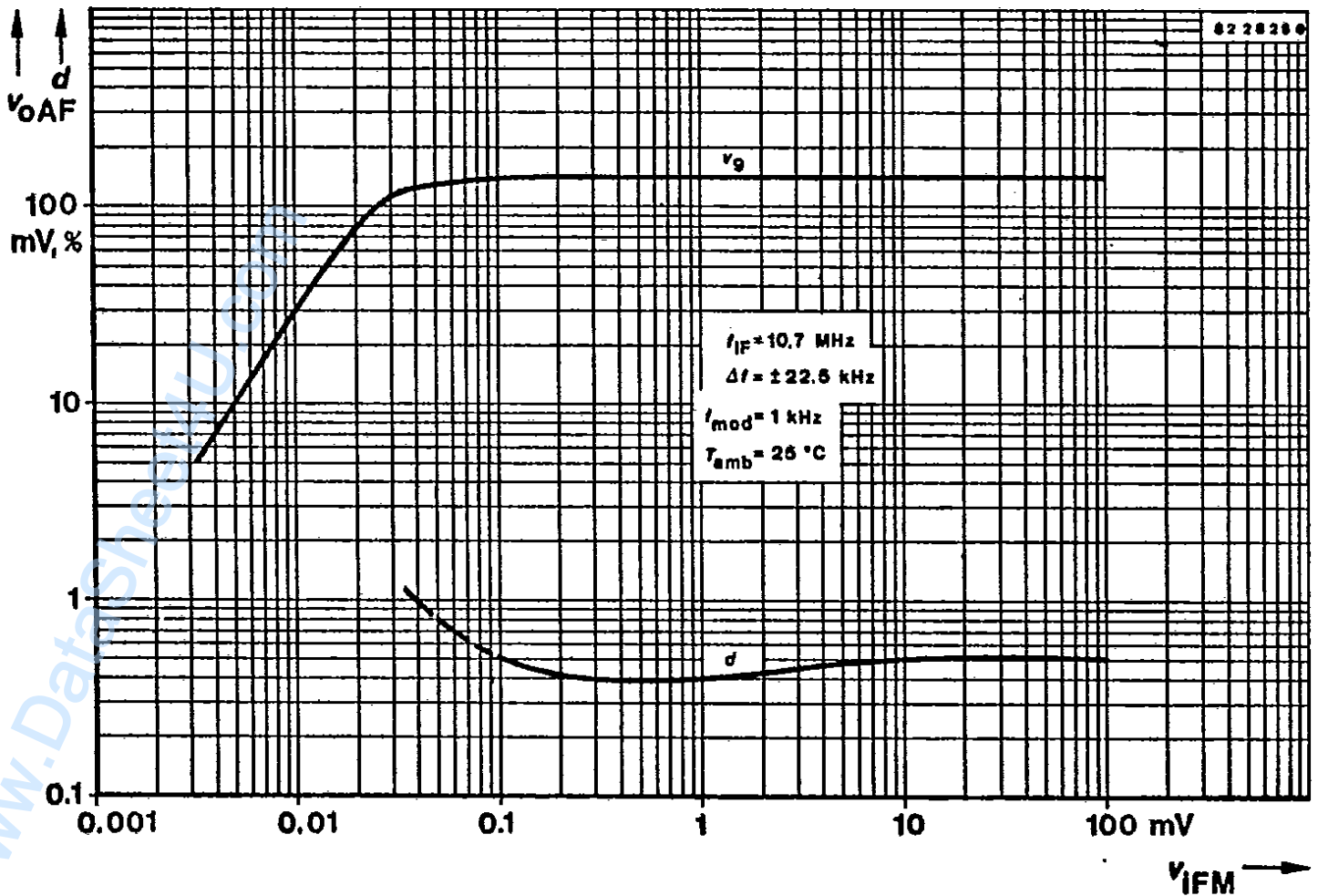
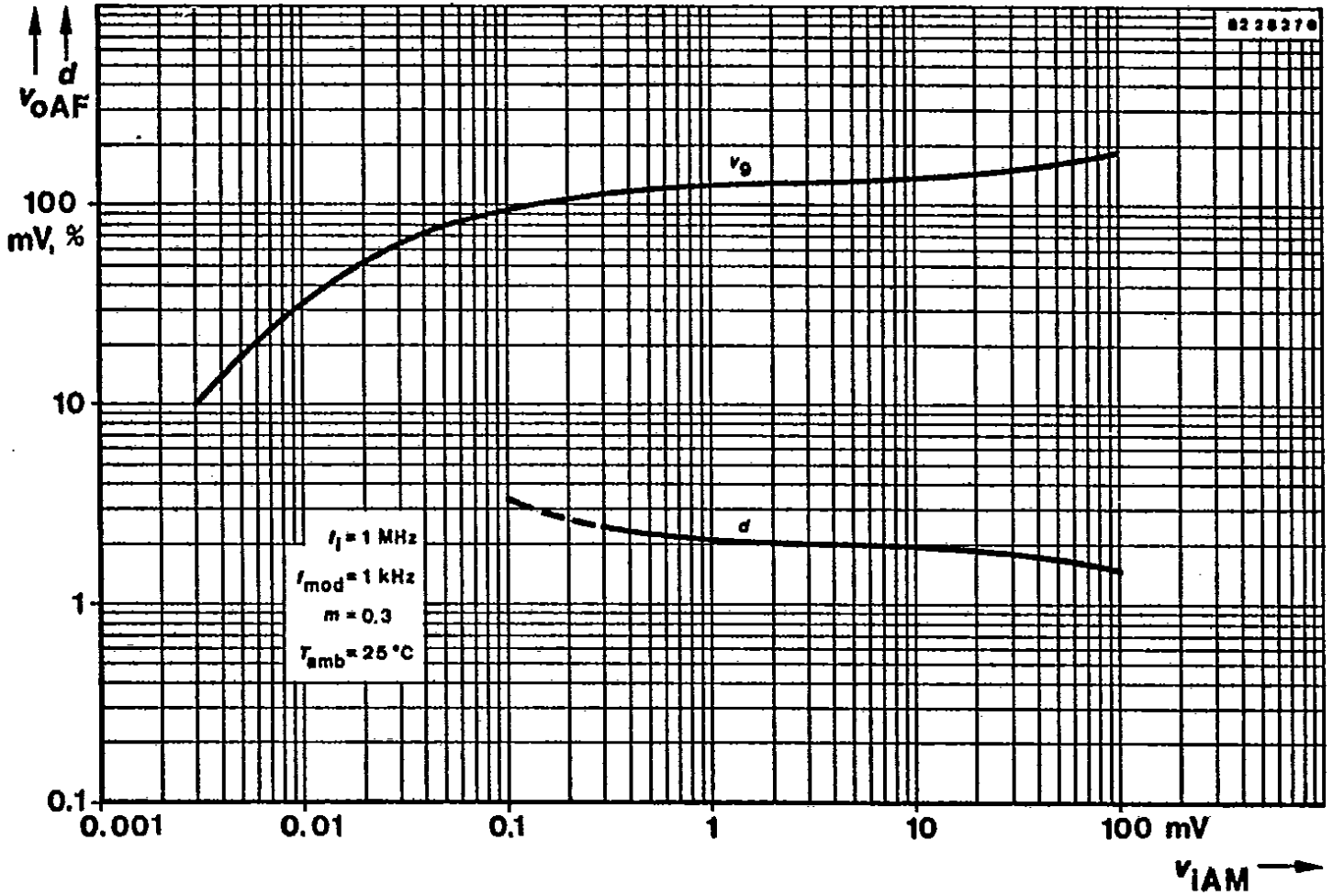

Fig. 2 FM-/AM-receiver circuit

www.DataSheet4U.com



T-77-05-07



### Dimensions in mm

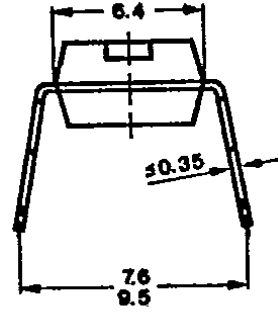
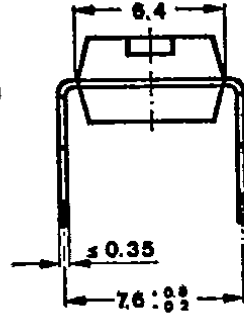
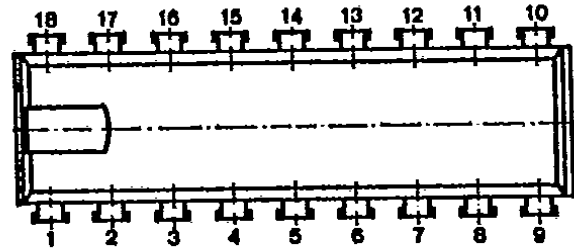
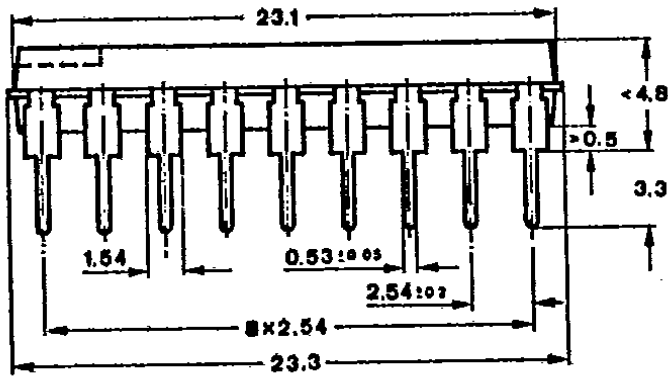

  
Technical drawings  
according to DIN  
specifications

3 010 0

Case  
20 A 18 DIN 41 866  
JEDEC MO 015 AH  
Weight max. 1.5 g