

### FEATURES

**Bias voltage range (VBIAS): 2.5 V to 5.5 V**  
**LDO input voltage range (VIN1/VIN2, VIN3): 1.8 V to 5.5 V**  
**Three 200 mA low dropout voltage regulators**  
**16-lead, 3 mm × 3 mm LFCSP**  
**Initial accuracy: ±1%**  
**Stable with 1 μF ceramic output capacitors**  
**No noise bypass capacitor required**  
**3 independent logic controlled enables**  
**Over current and thermal protection**

### Key specifications

#### High PSRR

**76 dB PSRR up to 1 kHz**  
**70 dB PSRR 10 kHz**  
**60 dB PSRR at 100 kHz**  
**40 dB PSRR at 1 MHz**

#### Low output noise

**29 μV rms typical output noise at  $V_{OUT} = 1.2 V$**   
**55 μV rms typical output noise at  $V_{OUT} = 2.8 V$**

### Excellent transient response

**Low dropout voltage: 110 mV @ 200 mA load**  
**85 μA typical ground current at no load, all LDOs enabled**  
**100 μs fast turn-on circuit**  
**Guaranteed 200 mA output current per regulator**  
**−40°C to +125°C junction temperature**

### APPLICATIONS

**Mobile phones**  
**Digital cameras and audio devices**  
**Portable and battery-powered equipment**  
**Portable medical devices**  
**Post dc-to-dc regulation**

### GENERAL DESCRIPTION

The ADP320 200 mA triple output LDO combines high PSRR, low noise, low quiescent current, and low dropout voltage in a voltage regulator ideally suited for wireless applications with demanding performance and board space requirements.

The low quiescent current, low dropout voltage, and wide input voltage range of the ADP320 triple LDO extend the battery life of portable devices. The ADP320 triple LDO maintains power supply rejection greater than 60 dB for frequencies as high as 100 kHz while operating with a low headroom voltage. The ADP320 triple

### TYPICAL APPLICATION CIRCUITS

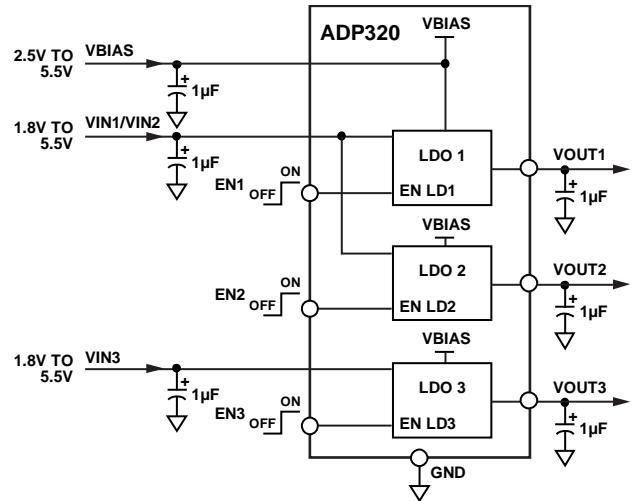

Figure 1. Typical Application Circuit

06874-001

LDO offers much lower noise performance than competing LDOs without the need for a noise bypass capacitor.

The ADP320 triple LDO is available in a miniature 16-lead 3 mm × 3 mm LFCSP package and is stable with tiny 1 μF ±30% ceramic output capacitors, resulting in the smallest possible board area for a wide variety of portable power needs.

The ADP320 triple LDO is available in output voltage combinations ranging from 0.8 V to 3.3 V and offers over current and thermal protection to prevent damage in adverse conditions.

#### Rev. A

Information furnished by Analog Devices is believed to be accurate and reliable. However, no responsibility is assumed by Analog Devices for its use, nor for any infringements of patents or other rights of third parties that may result from its use. Specifications subject to change without notice. No license is granted by implication or otherwise under any patent or patent rights of Analog Devices. Trademarks and registered trademarks are the property of their respective owners.

One Technology Way, P.O. Box 9106, Norwood, MA 02062-9106, U.S.A.  
 Tel: 781.329.4700 [www.analog.com](http://www.analog.com)  
 Fax: 781.461.3113 ©2010–2011 Analog Devices, Inc. All rights reserved.

## TABLE OF CONTENTS

|  |   |  |    |
|--|---|--|----|
| Features .....   | 1 | Typical Performance Characteristics .....          | 7  |
| Applications.....  | 1 | Theory of Operation .....                          | 14 |
| Typical Application Circuits.....                        | 1 | Applications Information .....                     | 15 |
| General Description .....                                | 1 | Capacitor Selection .....                          | 15 |
| Revision History .....                                   | 2 | Undervoltage Lockout .....                         | 16 |
| Specifications.....                                      | 3 | Enable Feature .....                               | 16 |
| Input and Output Capacitor, Recommended Specifications.. | 4 | Current-Limit and Thermal Overload Protection..... | 17 |
| Absolute Maximum Ratings.....                            | 5 | Thermal Considerations.....                        | 17 |
| Thermal Resistance .....                                 | 5 | Printed Circuit Board Layout Considerations.....   | 19 |
| ESD Caution.....   | 5 | Outline Dimensions .....                           | 20 |
| Pin Configurations and Function Descriptions .....       | 6 | Ordering Guide .....                               | 20 |

## REVISION HISTORY

### 4/11—Rev. 0 to Rev. A

|                                 |    |
|---------------------------------|----|
| Changes to Ordering Guide ..... | 20 |
|---------------------------------|----|

### 6/10—Revision 0: Initial Version

## SPECIFICATIONS

$V_{IN1}/V_{IN2} = V_{IN3} = (V_{OUT} + 0.5 \text{ V})$  or 1.8 V (whichever is greater),  $V_{BIAS} = 2.5 \text{ V}$ ,  $EN1, EN2, EN3 = V_{BIAS}$ ,  $I_{OUT1} = I_{OUT2} = I_{OUT3} = 10 \text{ mA}$ ,  $C_{IN} = C_{OUT1} = C_{OUT2} = C_{OUT3} = 1 \mu\text{F}$ , and  $T_A = 25^\circ\text{C}$ , unless otherwise noted.

Table 1.

| Parameter                             | Symbol                          | Conditions  | Min                                      | Typ   | Max   | Unit              |                                    |               |
|---------------------------------------|---------------------------------|---|--|-------|-------|-------------------|------------------------------------|---------------|
| INPUT BIAS VOLTAGE RANGE              | $V_{BIAS}$                      | $T_J = -40^\circ\text{C}$ to $+125^\circ\text{C}$   | 2.5                                      |       | 5.5   | V                 |                                    |               |
| INPUT LDO VOLTAGE RANGE               | $V_{IN1}/V_{IN2}/V_{IN3}$       | $T_J = -40^\circ\text{C}$ to $+125^\circ\text{C}$   | 1.8                                      |       | 5.5   | V                 |                                    |               |
| GROUND CURRENT WITH ALL REGULATORS ON | $I_{GND}$                       | $I_{OUT} = 0 \mu\text{A}$   |  | 85    |       | $\mu\text{A}$     |                                    |               |
|                                       |                                 | $I_{OUT} = 0 \mu\text{A}$ , $T_J = -40^\circ\text{C}$ to $+125^\circ\text{C}$   |  |       | 160   | $\mu\text{A}$     |                                    |               |
|                                       |                                 | $I_{OUT} = 10 \text{ mA}$   |  | 120   |       | $\mu\text{A}$     |                                    |               |
|                                       |                                 | $I_{OUT} = 10 \text{ mA}$ , $T_J = -40^\circ\text{C}$ to $+125^\circ\text{C}$   |  |       | 220   | $\mu\text{A}$     |                                    |               |
|                                       |                                 | $I_{OUT} = 200 \text{ mA}$  |  | 250   |       | $\mu\text{A}$     |                                    |               |
|                                       |                                 | $I_{OUT} = 200 \text{ mA}$ , $T_J = -40^\circ\text{C}$ to $+125^\circ\text{C}$  |  |       | 380   | $\mu\text{A}$     |                                    |               |
| INPUT BIAS CURRENT                    | $I_{BIAS}$                      | $T_J = -40^\circ\text{C}$ to $+125^\circ\text{C}$   |  | 66    |       | $\mu\text{A}$     |                                    |               |
|                                       |                                 |   |  |       | 140   | $\mu\text{A}$     |                                    |               |
| SHUTDOWN CURRENT                      | $I_{GND-SD}$                    | $EN1 = EN2 = EN3 = \text{GND}$  |  | 0.1   |       | $\mu\text{A}$     |                                    |               |
|                                       |                                 | $EN1 = EN2 = EN3 = \text{GND}$ , $T_J = -40^\circ\text{C}$ to $+125^\circ\text{C}$  |  |       | 2.5   | $\mu\text{A}$     |                                    |               |
| OUTPUT VOLTAGE ACCURACY               | $V_{OUT}$                       | $100 \mu\text{A} < I_{OUT} < 200 \text{ mA}$ , $V_{IN} = (V_{OUT} + 0.5 \text{ V})$ to 5.5 V, $T_J = -40^\circ\text{C}$ to $+125^\circ\text{C}$ | -1                                       |       | +1    | %                 |                                    |               |
|                                       |                                 |   | -2                                       |       | +2    | %                 |                                    |               |
| LINE REGULATION                       | $\Delta V_{OUT}/\Delta V_{IN}$  | $V_{IN} = (V_{OUT} + 0.5 \text{ V})$ to 5.5 V   |  | 0.01  |       | %/V               |                                    |               |
|                                       |                                 | $V_{IN} = (V_{OUT} + 0.5 \text{ V})$ to 5.5 V, $T_J = -40^\circ\text{C}$ to $+125^\circ\text{C}$  | -0.03                                    |       | +0.03 | %/V               |                                    |               |
| LOAD REGULATION <sup>1</sup>          | $\Delta V_{OUT}/\Delta I_{OUT}$ | $I_{OUT} = 1 \text{ mA}$ to 200 mA  |  | 0.001 |       | %/mA              |                                    |               |
|                                       |                                 | $I_{OUT} = 1 \text{ mA}$ to 200 mA, $T_J = -40^\circ\text{C}$ to $+125^\circ\text{C}$   |  |       | 0.005 | %/mA              |                                    |               |
| DROPOUT VOLTAGE <sup>2</sup>          | $V_{DROPOUT}$                   | $V_{OUT} = 3.3 \text{ V}$   |  | 6     |       | mV                |                                    |               |
|                                       |                                 | $I_{OUT} = 10 \text{ mA}$   |  |       | 9     | mV                |                                    |               |
|                                       |                                 | $I_{OUT} = 10 \text{ mA}$ , $T_J = -40^\circ\text{C}$ to $+125^\circ\text{C}$   |  |       |       | mV                |                                    |               |
|                                       |                                 | $I_{OUT} = 200 \text{ mA}$  |  | 110   |       | mV                |                                    |               |
|                                       |                                 | $I_{OUT} = 200 \text{ mA}$ , $T_J = -40^\circ\text{C}$ to $+125^\circ\text{C}$  |  |       | 170   | mV                |                                    |               |
| START-UP TIME <sup>3</sup>            | $T_{START-UP}$                  | $V_{OUT} = 3.3 \text{ V}$ , all $V_{OUT}$ initially off, enable one   |  | 240   |       | $\mu\text{s}$     |                                    |               |
|                                       |                                 | $V_{OUT} = 0.8 \text{ V}$   |  | 100   |       | $\mu\text{s}$     |                                    |               |
|                                       |                                 | $V_{OUT} = 3.3 \text{ V}$ , one $V_{OUT}$ initially on, enable second   |  | 160   |       | $\mu\text{s}$     |                                    |               |
|                                       |                                 | $V_{OUT} = 0.8 \text{ V}$   |  | 20    |       | $\mu\text{s}$     |                                    |               |
| CURRENT LIMIT THRESHOLD <sup>4</sup>  | $I_{LIMIT}$                     |   | 250                                      | 360   | 600   | mA                |                                    |               |
| THERMAL SHUTDOWN                      |                                 | $T_J$ rising  |  | 155   |       | $^\circ\text{C}$  |                                    |               |
|                                       |                                 |   |  |       | 15    |                   | $^\circ\text{C}$                   |               |
| EN INPUT                              |                                 |   | 2.5 V $\leq V_{BIAS} \leq 5.5 \text{ V}$ | 1.2   | 0.4   | V                 |                                    |               |
|                                       |                                 |   |  |       |       |                   | EN Input Logic High                | $V_{IH}$      |
|                                       |                                 |   |  |       |       |                   | EN Input Logic Low                 | $V_{IL}$      |
| EN Input Leakage Current              | $V_{I-LEAKAGE}$                 | $EN1 = EN2 = EN3 = V_{IN}$ or GND   |  | 0.1   |       | $\mu\text{A}$     |                                    |               |
|                                       |                                 | $EN1 = EN2 = EN3 = V_{IN}$ or GND, $T_J = -40^\circ\text{C}$ to $+125^\circ\text{C}$  |  |       | 1     | $\mu\text{A}$     |                                    |               |
| UNDERVOLTAGE LOCKOUT                  |                                 |   | 2.0                                      | 180   | 2.45  | V                 |                                    |               |
|                                       |                                 |   |  |       |       |                   | Input Bias Voltage (VBIAS) Rising  | $UVLO_{RISE}$ |
|                                       |                                 |   |  |       |       |                   | Input Bias Voltage (VBIAS) Falling | $UVLO_{FALL}$ |
| Hysteresis                            | $UVLO_{HYS}$                    |   |  |       |       | mV                |                                    |               |
| OUTPUT NOISE                          | $OUT_{NOISE}$                   | 10 Hz to 100 kHz, $V_{IN} = 5 \text{ V}$ , $V_{OUT} = 3.3 \text{ V}$  |  | 63    |       | $\mu\text{V rms}$ |                                    |               |
|                                       |                                 | 10 Hz to 100 kHz, $V_{IN} = 5 \text{ V}$ , $V_{OUT} = 2.8 \text{ V}$  |  | 55    |       | $\mu\text{V rms}$ |                                    |               |
|                                       |                                 | 10 Hz to 100 kHz, $V_{IN} = 3.6 \text{ V}$ , $V_{OUT} = 2.5 \text{ V}$  |  | 50    |       | $\mu\text{V rms}$ |                                    |               |
|                                       |                                 | 10 Hz to 100 kHz, $V_{IN} = 3.6 \text{ V}$ , $V_{OUT} = 1.2 \text{ V}$  |  | 29    |       | $\mu\text{V rms}$ |                                    |               |

# ADP320

| Parameter                    | Symbol | Conditions   | Min     | Typ | Max | Unit |
|------------------------------|--------|--|---------|-----|-----|------|
| POWER SUPPLY REJECTION RATIO | PSRR   | $V_{IN} = 1.8\text{ V}, V_{OUT} = 0.8\text{ V}, I_{OUT} = 100\text{ mA}$ | 100 Hz  | 70  |     | dB   |
|                              |        |  | 1 kHz   | 70  |     | dB   |
|                              |        |  | 10 kHz  | 70  |     | dB   |
|                              |        |  | 100 kHz | 60  |     | dB   |
|                              |        |  | 1 MHz   | 40  |     | dB   |
|                              |        | $V_{IN} = 3.8\text{ V}, V_{OUT} = 2.8\text{ V}, I_{OUT} = 100\text{ mA}$ | 100 Hz  | 68  |     | dB   |
|                              |        |  | 1 kHz   | 62  |     | dB   |
|                              |        |  | 10 kHz  | 68  |     | dB   |
|                              |        |  | 100 kHz | 60  |     | dB   |
|                              |        |  | 1 MHz   | 40  |     | dB   |

<sup>1</sup> Based on an end-point calculation using 1 mA and 200 mA loads.

<sup>2</sup> Dropout voltage is defined as the input-to-output voltage differential when the input voltage is set to the nominal output voltage. This applies only for output voltages above 1.8 V.

<sup>3</sup> Start-up time is defined as the time between the rising edge of ENx to  $V_{OUTx}$  being at 90% of its nominal value.

<sup>4</sup> Current-limit threshold is defined as the current at which the output voltage drops to 90% of the specified typical value. For example, the current limit for a 3.0 V output voltage is defined as the current that causes the output voltage to drop to 90% of 3.0 V, or 2.7 V.

## INPUT AND OUTPUT CAPACITOR, RECOMMENDED SPECIFICATIONS

Table 2.

| Parameter   | Symbol    | Conditions                                       | Min   | Typ | Max | Unit          |
|---|-----------|--|-------|-----|-----|---------------|
| MINIMUM INPUT AND OUTPUT CAPACITANCE <sup>1</sup> | $C_{MIN}$ | $T_A = -40^\circ\text{C to } +125^\circ\text{C}$ | 0.70  |     |     | $\mu\text{F}$ |
| CAPACITOR ESR                                     | $R_{ESR}$ | $T_A = -40^\circ\text{C to } +125^\circ\text{C}$ | 0.001 |     | 1   | $\Omega$      |

<sup>1</sup> The minimum input and output capacitance should be greater than 0.70  $\mu\text{F}$  over the full range of operating conditions. The full range of operating conditions in the application must be considered during device selection to ensure that the minimum capacitance specification is met. X7R and X5R type capacitors are recommended, Y5V and Z5U capacitors are not recommended for use with LDOs.

## ABSOLUTE MAXIMUM RATINGS

Table 3.

| Parameter                            | Rating              |
|--------------------------------------|---------------------|
| VIN1/VIN2, VIN3, VBIAS to GND        | −0.3 V to +6.5 V    |
| VOUT1, VOUT2 to GND                  | −0.3 V to VIN1/VIN2 |
| VOUT3 to GND                         | −0.3 V to VIN3      |
| EN1, EN2, EN3 to GND                 | −0.3 V to +6.5 V    |
| Storage Temperature Range            | −65°C to +150°C     |
| Operating Junction Temperature Range | −40°C to +125°C     |
| Soldering Conditions                 | JEDEC J-STD-020     |

Stresses above those listed under absolute maximum ratings may cause permanent damage to the device. This is a stress rating only and functional operation of the device at these or any other conditions above those indicated in the operational section of this specification is not implied. Exposure to absolute maximum rating conditions for extended periods may affect device reliability.

### THERMAL DATA

Absolute maximum ratings apply individually only, not in combination.

The ADP320 triple LDO can be damaged when the junction temperature limits are exceeded. Monitoring ambient temperature does not guarantee that the junction temperature ( $T_J$ ) is within the specified temperature limits. In applications with high power dissipation and poor thermal resistance the maximum ambient temperature may have to be derated. In applications with moderate power dissipation and low PCB thermal resistance, the maximum ambient temperature can exceed the maximum limit as long as the junction temperature is within specification limits.

The junction temperature ( $T_J$ ) of the device is dependent on the ambient temperature ( $T_A$ ), the power dissipation of the device ( $P_D$ ), and the junction-to-ambient thermal resistance of the package ( $\theta_{JA}$ ). Maximum junction temperature ( $T_J$ ) is calculated from the ambient temperature ( $T_A$ ) and power dissipation ( $P_D$ ) using the following formula:

$$T_J = T_A + (P_D \times \theta_{JA})$$

Junction-to-ambient thermal resistance ( $\theta_{JA}$ ) of the package is based on modeling and calculation using a 4-layer board. The junction-to-ambient thermal resistance is highly dependent on the application and board layout. In applications where high maximum power dissipation exists, close attention to thermal board design is required. The value of  $\theta_{JA}$  may vary, depending on PCB material, layout, and environmental conditions. The specified values of  $\theta_{JA}$  are based on a four-layer, 4-inch  $\times$  3-inch circuit board. Refer to JEDEC JESD 51-9 for detailed information on the board construction. For additional information, see the AN-617 Application Note, *MicroCSP™ Wafer Level Chip Scale Package*.

$\Psi_{JB}$  is the junction to board thermal characterization parameter with units of °C/W.  $\Psi_{JB}$  of the package is based on modeling and calculation using a 4-layer board. The JESD51-12, *Guidelines for Reporting and Using Package Thermal Information*, states that thermal characterization parameters are not the same as thermal resistances.  $\Psi_{JB}$  measures the component power flowing through multiple thermal paths rather than a single path as in thermal resistance,  $\theta_{JB}$ . Therefore,  $\Psi_{JB}$  thermal paths include convection from the top of the package as well as radiation from the package; factors that make  $\Psi_{JB}$  more useful in real-world applications. Maximum junction temperature ( $T_J$ ) is calculated from the board temperature ( $T_B$ ) and power dissipation ( $P_D$ ) using the following formula

$$T_J = T_B + (P_D \times \Psi_{JB})$$

Refer to JEDEC JESD51-8 and JESD51-12 for more detailed information about  $\Psi_{JB}$ .

### THERMAL RESISTANCE

$\theta_{JA}$  and  $\Psi_{JB}$  are specified for the worst-case conditions, that is, a device soldered in a circuit board for surface-mount packages.

Table 4.

| Package Type                     | $\theta_{JA}$ | $\Psi_{JB}$ | Unit |
|----------------------------------|---------------|-------------|------|
| 16-Lead 3 mm $\times$ 3 mm LFCSP | 49.5          | 25.2        | °C/W |

### ESD CAUTION



**ESD (electrostatic discharge) sensitive device.** Charged devices and circuit boards can discharge without detection. Although this product features patented or proprietary protection circuitry, damage may occur on devices subjected to high energy ESD. Therefore, proper ESD precautions should be taken to avoid performance degradation or loss of functionality.

## PIN CONFIGURATIONS AND FUNCTION DESCRIPTIONS

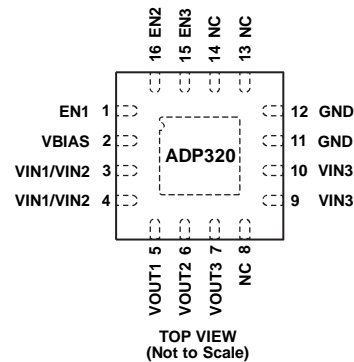

**NOTES**  
 1. NC = NO CONNECT.  
 2. CONNECT EXPOSED PAD TO GROUND PLANE.

09874-002

Figure 2. Pin Configuration

Table 5. Pin Function Descriptions

| Pin No. | Mnemonic  | Description   |
|---------|-----------|---|
| 1       | EN1       | Enable Input for Regulator 1. Drive EN1 high to turn on Regulator 1; drive it low to turn off Regulator 1. For automatic startup, connect EN1 to VBIAS. |
| 2       | VBIAS     | Input Voltage Bias Supply. Bypass VBIAS to GND with a 1 $\mu$ F or greater capacitor.   |
| 3       | VIN1/VIN2 | Regulator Input Supply for Output Voltage 1 and Output Voltage 2. Bypass VIN1/VIN2 to GND with a 1 $\mu$ F or greater capacitor.                        |
| 4       | VIN1/VIN2 | Regulator Input Supply for Output Voltage 1 and Output Voltage 2. Bypass VIN1/VIN2 to GND with a 1 $\mu$ F or greater capacitor.                        |
| 5       | VOUT1     | Regulated Output Voltage 1. Connect a 1 $\mu$ F or greater output capacitor between VOUT1 and GND.  |
| 6       | VOUT2     | Regulated Output Voltage 2. Connect a 1 $\mu$ F or greater output capacitor between VOUT2 and GND.  |
| 7       | VOUT3     | Regulated Output Voltage 3. Connect a 1 $\mu$ F or greater output capacitor between VOUT3 and GND.  |
| 8       | NC        | Not connected internally.   |
| 9       | VIN3      | Regulator Input Supply for Output Voltage 3. Bypass VIN3 to GND with a 1 $\mu$ F or greater capacitor.  |
| 10      | VIN3      | Regulator Input Supply for Output Voltage 3. Bypass VIN3 to GND with a 1 $\mu$ F or greater capacitor.  |
| 11      | GND       | Ground Pin.   |
| 12      | GND       | Ground Pin.   |
| 13      | NC        | Not connected internally.   |
| 14      | NC        | Not connected internally.   |
| 15      | EN3       | Enable Input for Regulator 3. Drive EN3 high to turn on Regulator 3; drive it low to turn off Regulator 3. For automatic startup, connect EN3 to VBIAS. |
| 16      | EN2       | Enable Input for Regulator 2. Drive EN1 high to turn on Regulator 2; drive it low to turn off Regulator 2. For automatic startup, connect EN2 to VBIAS. |
| EP      | EP        | Exposed pad for enhanced thermal performance. Connect to copper ground plane.   |

## TYPICAL PERFORMANCE CHARACTERISTICS

$V_{IN1}/V_{IN2} = V_{IN3} = V_{BIAS} = 4\text{ V}$ ,  $V_{OUT1} = 3.3\text{ V}$ ,  $V_{OUT2} = 1.8\text{ V}$ ,  $V_{OUT3} = 1.5\text{ V}$ ,  $I_{OUT} = 10\text{ mA}$ ,  $C_{IN} = C_{OUT1} = C_{OUT2} = C_{OUT3} = 1\text{ }\mu\text{F}$ ,  $T_A = 25^\circ\text{C}$ , unless otherwise noted.

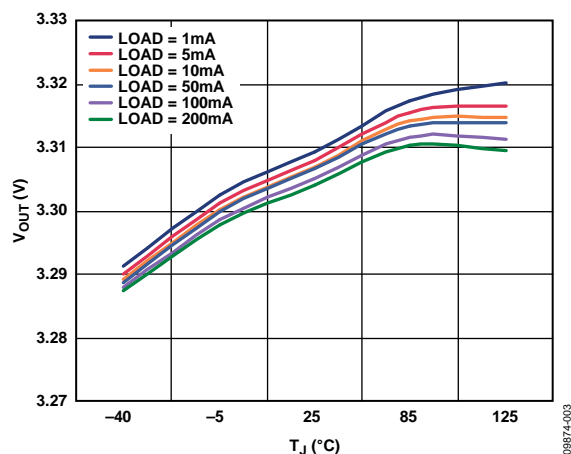

Figure 3. Output Voltage vs. Junction Temperature

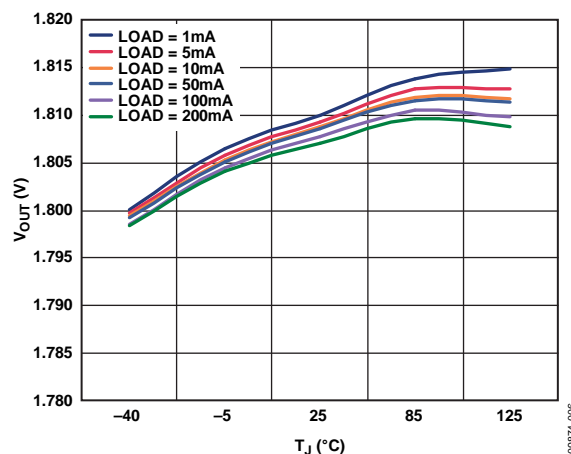

Figure 6. Output Voltage vs. Junction Temperature

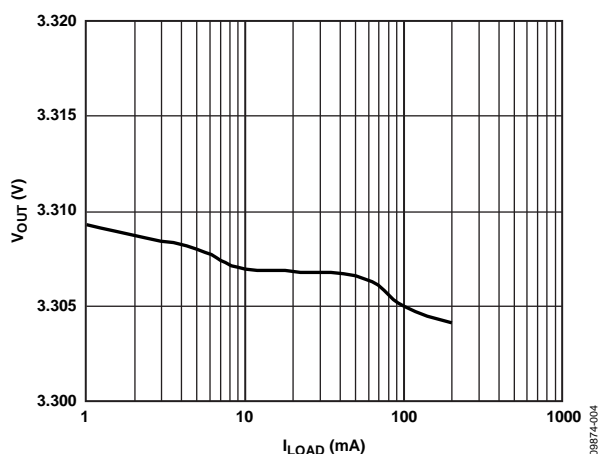

Figure 4. Output Voltage vs. Load Current

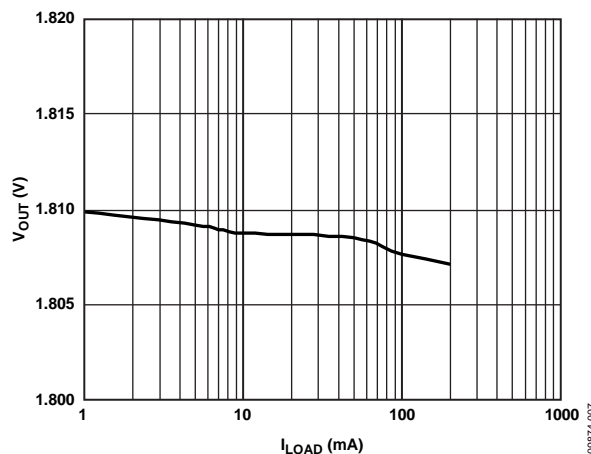

Figure 7. Output Voltage vs. Load Current

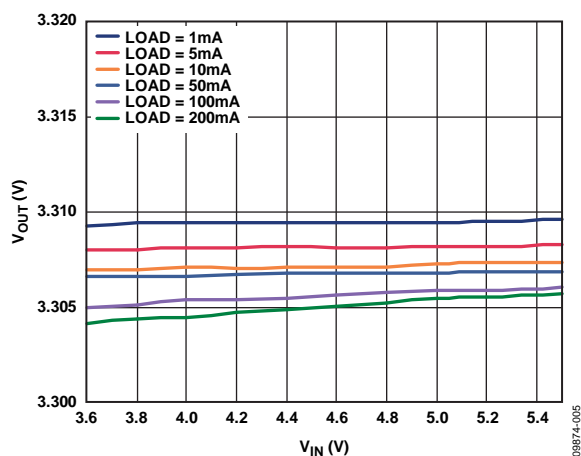

Figure 5. Output Voltage vs. Input Voltage

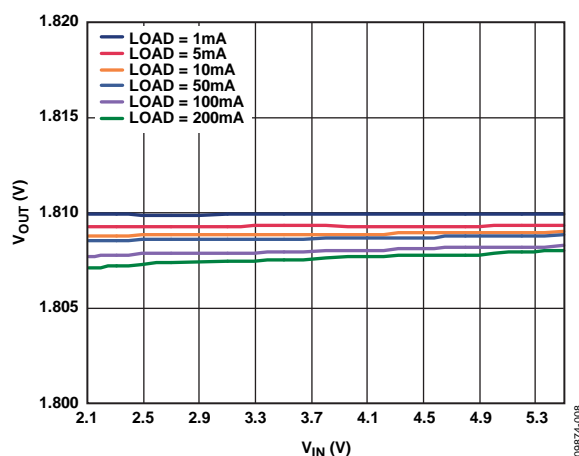

Figure 8. Output Voltage vs. Input Voltage

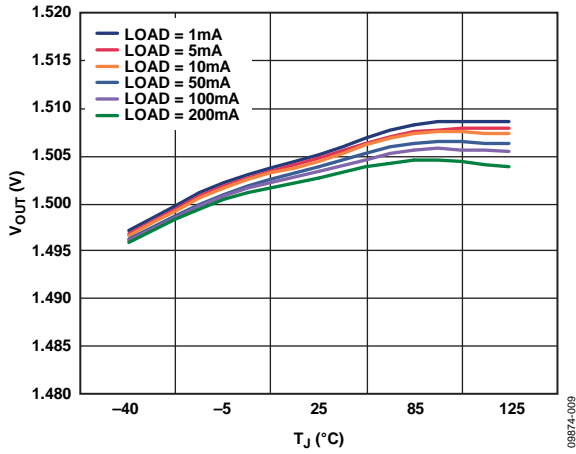

Figure 9. Output Voltage vs. Junction Temperature

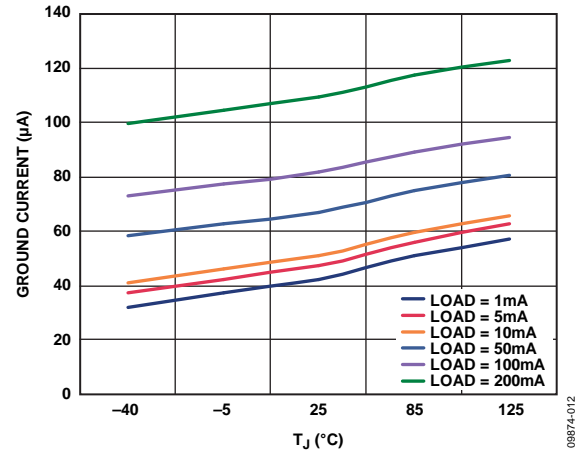

Figure 12. Ground Current vs. Junction Temperature, Single Output Loaded

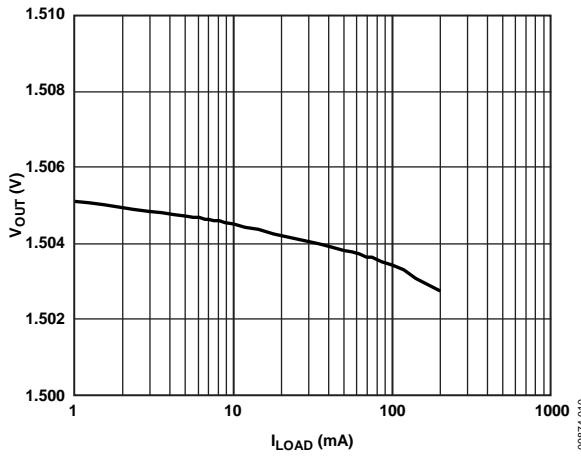

Figure 10. Output Voltage vs. Load Current

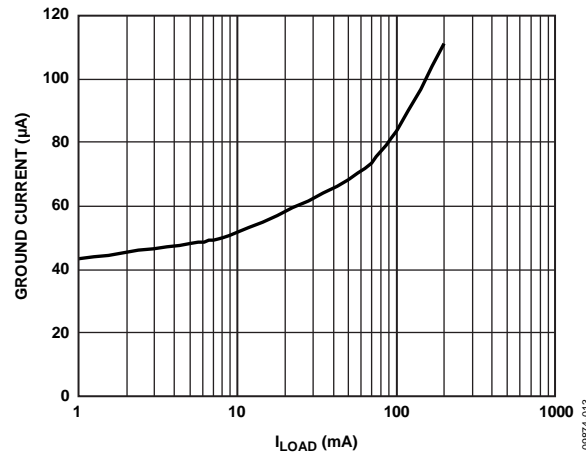

Figure 13. Ground Current vs. Load Current, Single Output Loaded

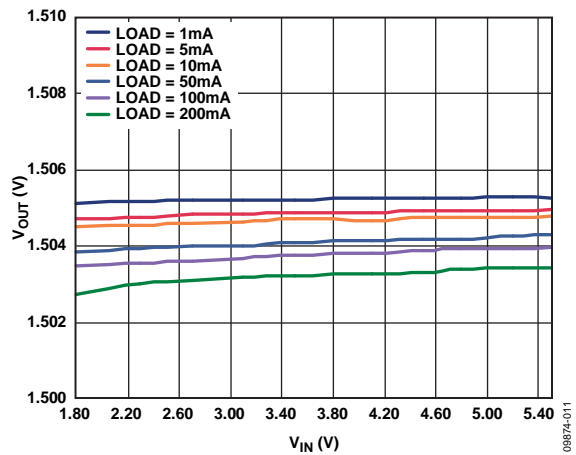

Figure 11. Output Voltage vs. Input Voltage

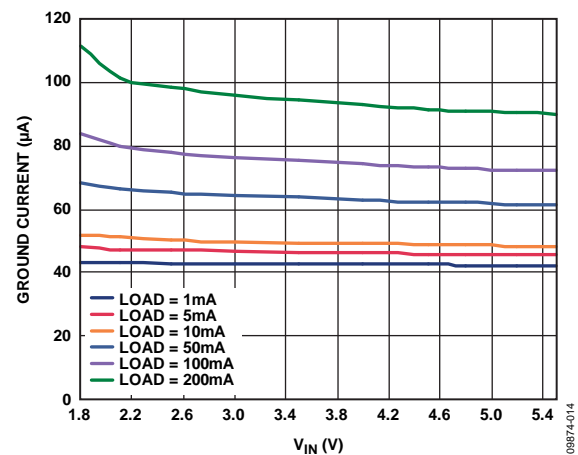

Figure 14. Ground Current vs. Input Voltage, Single Output Loaded



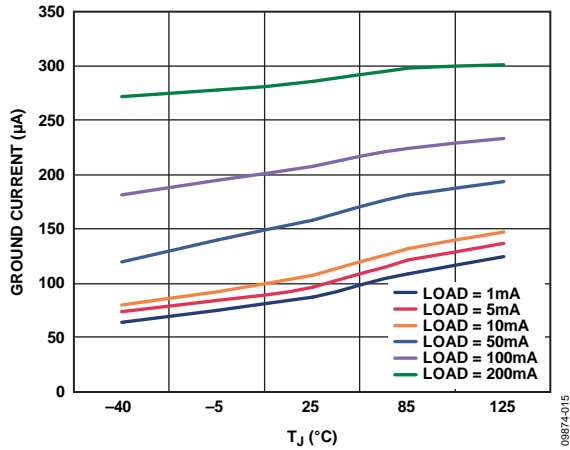

Figure 15. Ground Current vs. Junction Temperature, All Outputs Loaded Equally

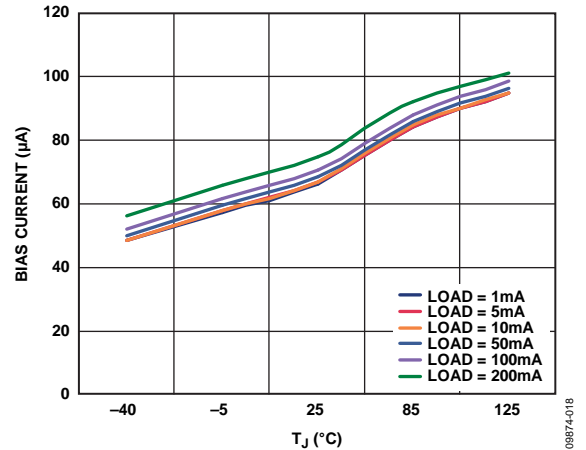

Figure 18. Bias Current vs. Junction Temperature, Single Output Loaded

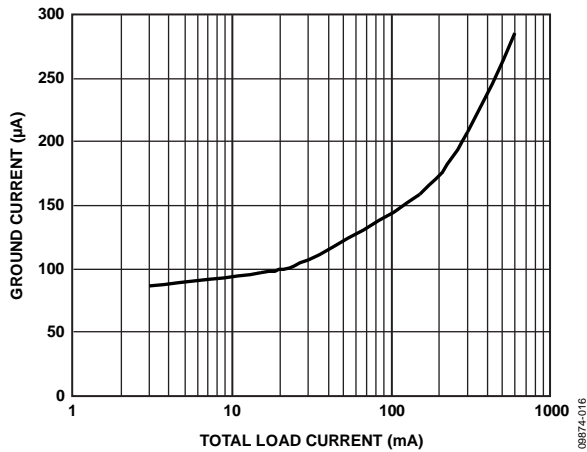

Figure 16. Ground Current vs. Load Current, All Outputs Loaded Equally

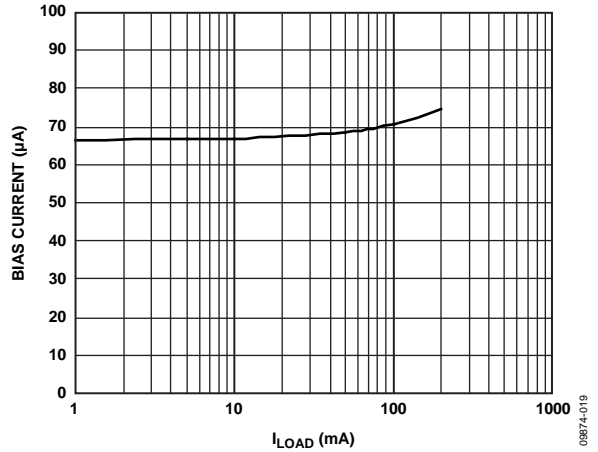

Figure 19. Bias Current vs. Load Current, Single Output Load

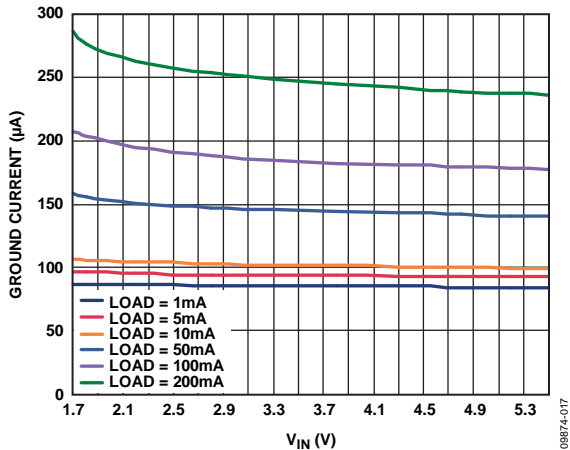

Figure 17. Ground Current vs. Input Voltage, All Outputs Loaded Equally

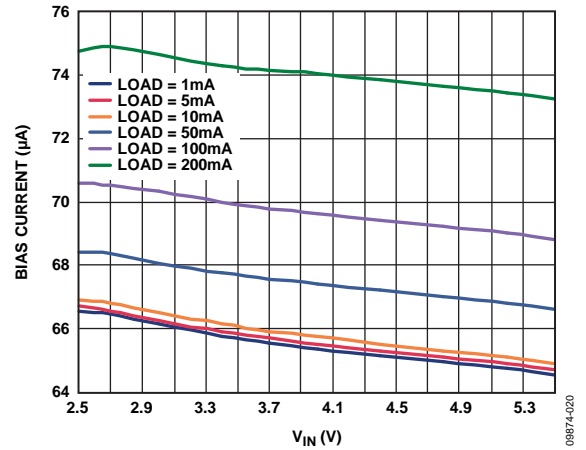

Figure 20. Bias Current vs. Input Voltage, Single Output Load

# ADP320

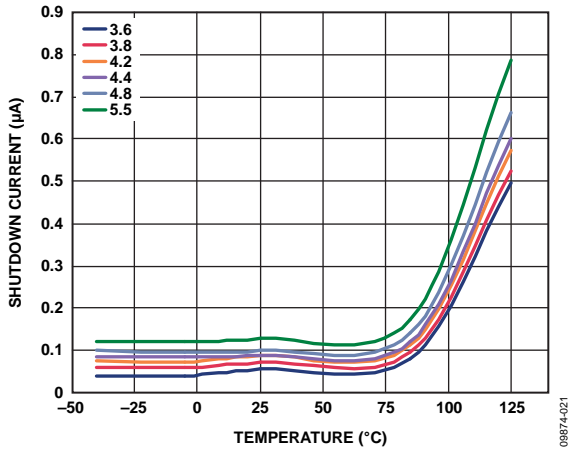

Figure 21. Shutdown Current vs. Temperature at Various Input Voltages

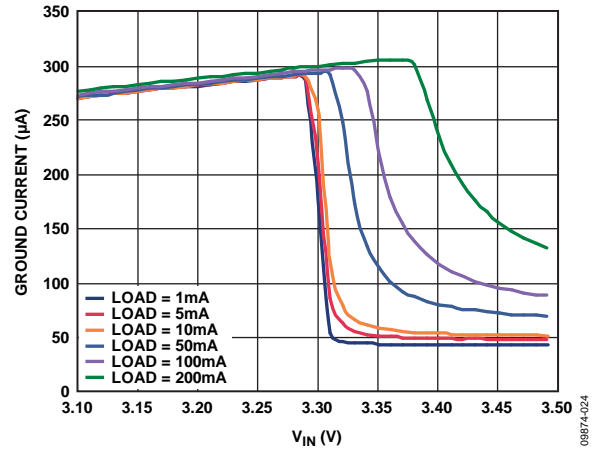

Figure 24. Ground Current vs. Input Voltage (in Dropout),  $V_{OUT1} = 3.3\text{ V}$

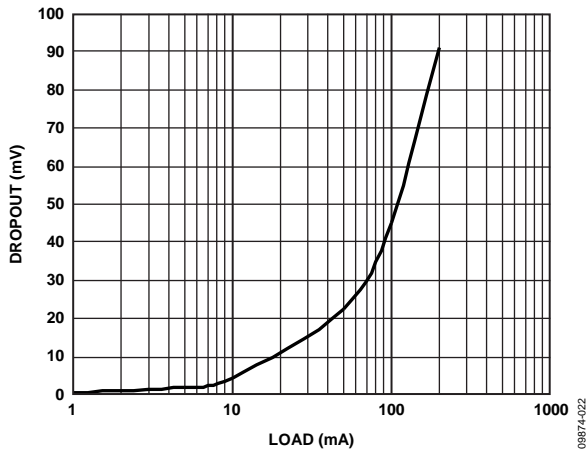

Figure 22. Dropout Voltage vs. Load Current and Output Voltage,  $V_{OUT1} = 3.3\text{ V}$

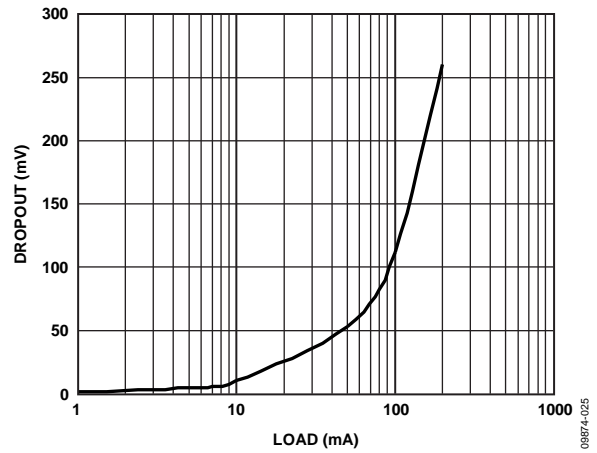

Figure 25. Dropout Voltage vs. Load Current and Output Voltage,  $V_{OUT2} = 1.8\text{ V}$

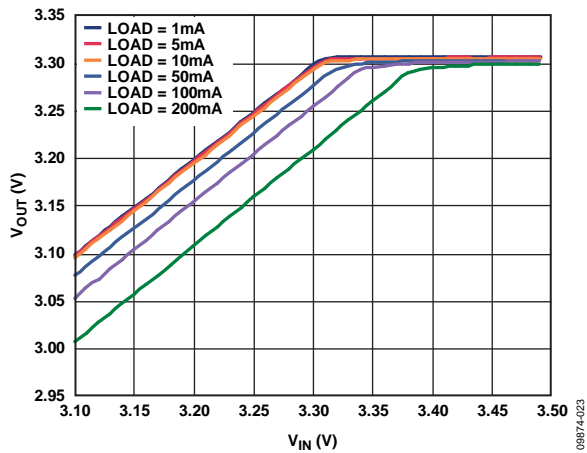

Figure 23. Output Voltage vs. Input Voltage (In Dropout),  $V_{OUT1} = 3.3\text{ V}$

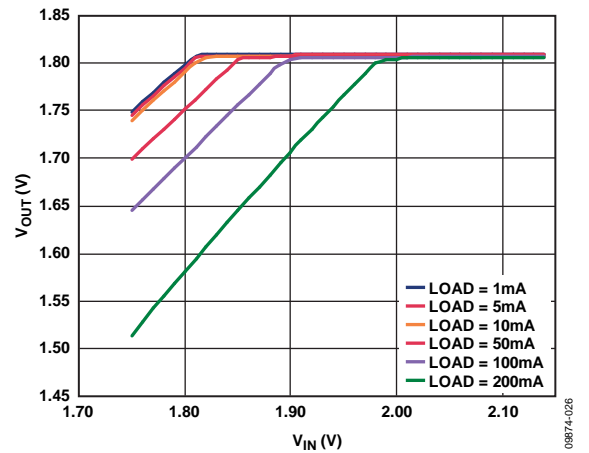

Figure 26. Output Voltage vs. Input Voltage (in Dropout),  $V_{OUT2} = 1.8\text{ V}$

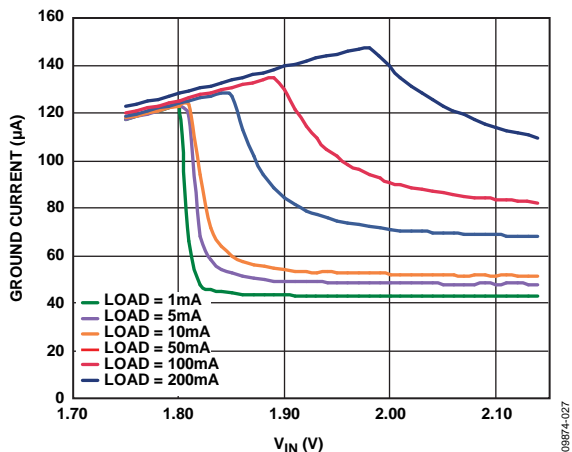

Figure 27. Ground Current vs. Input Voltage in Dropout,  $V_{OUT2} = 1.8\text{ V}$

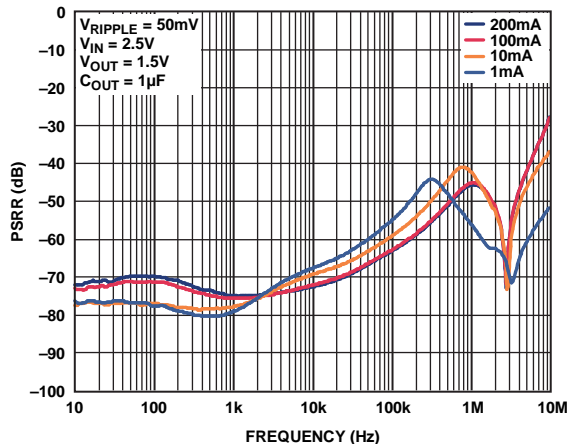

Figure 30. Power Supply Rejection Ratio vs. Frequency, 1.5 V

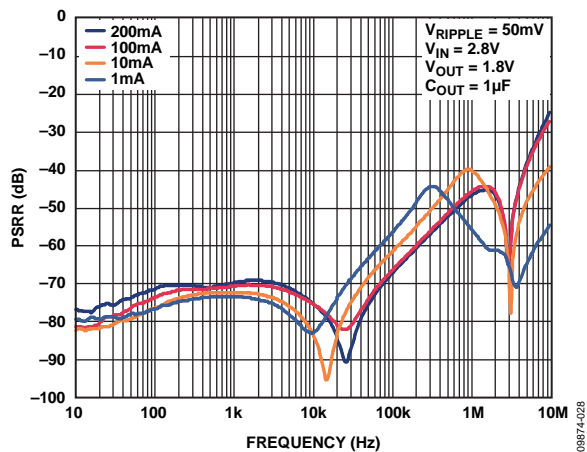

Figure 28. Power Supply Rejection Ratio vs. Frequency, 1.8 V

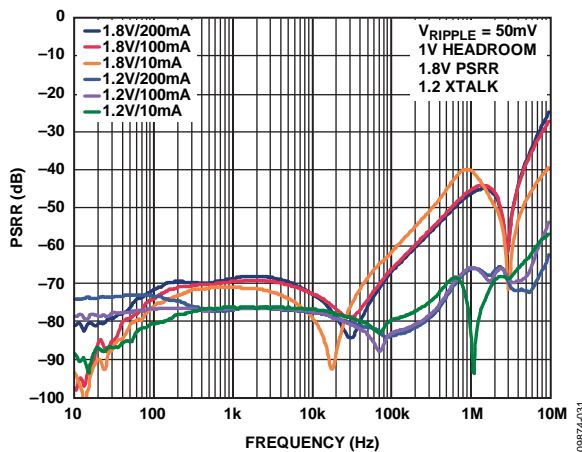

Figure 31. Power Supply Rejection Ratio vs. Frequency, Channel to Channel Crosstalk

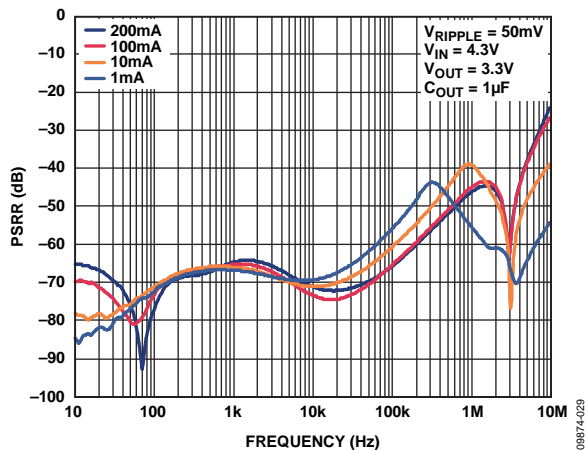

Figure 29. Power Supply Rejection Ratio vs. Frequency, 3.3 V

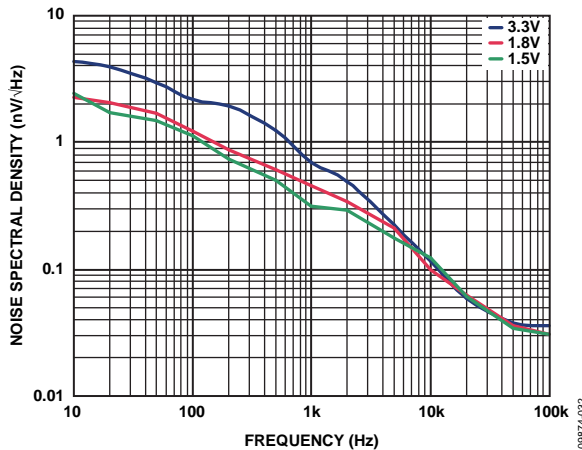

Figure 32. Output Noise Spectral Density,  $V_{IN} = 5\text{ V}$ ,  $I_{LOAD} = 10\text{ mA}$

# ADP320

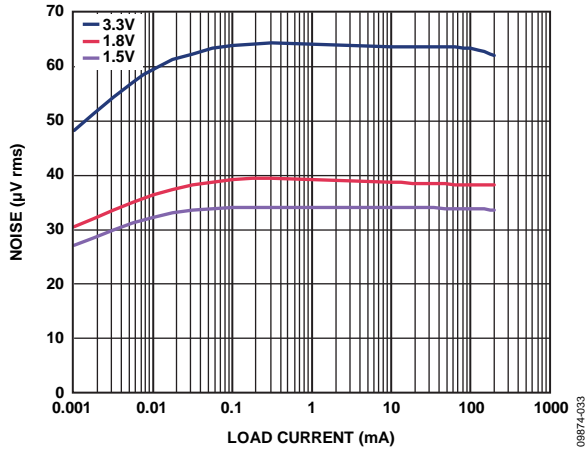

Figure 33. Output Noise vs. Load Current and Output Voltage,  $V_{IN} = 5V$

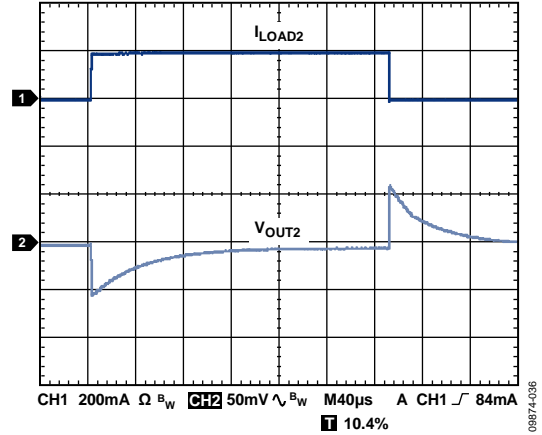

Figure 36. Load Transient Response,  $I_{LOAD2} = 1\text{ mA to } 200\text{ mA}$ ,  $C_{OUT2} = 1\text{ }\mu\text{F}$ ,  $CH1 = I_{LOAD2}$ ,  $CH2 = V_{OUT2}$

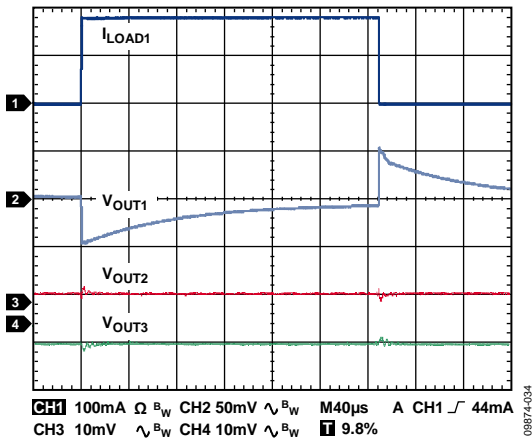

Figure 34. Load Transient Response,  $I_{LOAD1} = 1\text{ mA to } 200\text{ mA}$ ,  $I_{LOAD2} = I_{LOAD3} = 1\text{ mA}$ ,  $CH1 = I_{LOAD1}$ ,  $CH2 = V_{OUT1}$ ,  $CH3 = V_{OUT2}$ ,  $CH4 = V_{OUT3}$

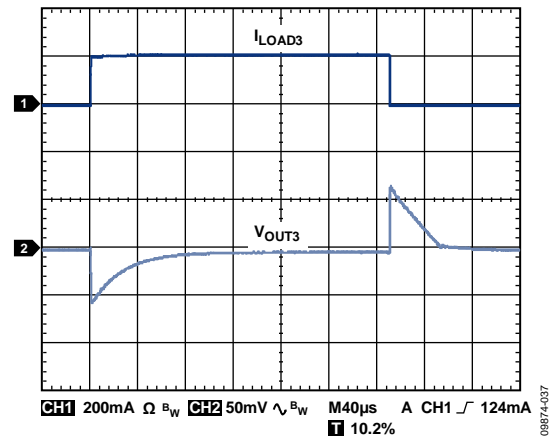

Figure 37. Load Transient Response,  $I_{LOAD3} = 1\text{ mA to } 200\text{ mA}$ ,  $C_{OUT3} = 1\text{ }\mu\text{F}$ ,  $CH1 = I_{LOAD3}$ ,  $CH2 = V_{OUT3}$

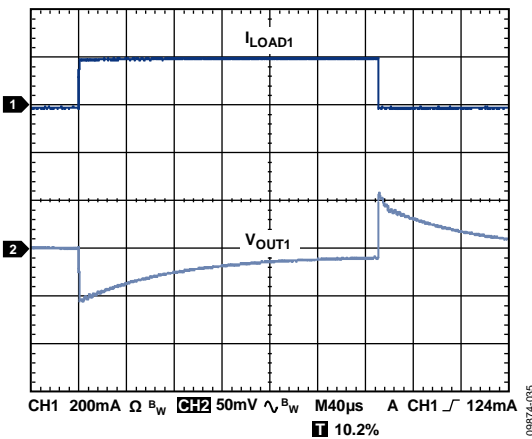

Figure 35. Load Transient Response,  $I_{LOAD1} = 1\text{ mA to } 200\text{ mA}$ ,  $C_{OUT1} = 1\text{ }\mu\text{F}$ ,  $CH1 = I_{LOAD1}$ ,  $CH2 = V_{OUT1}$

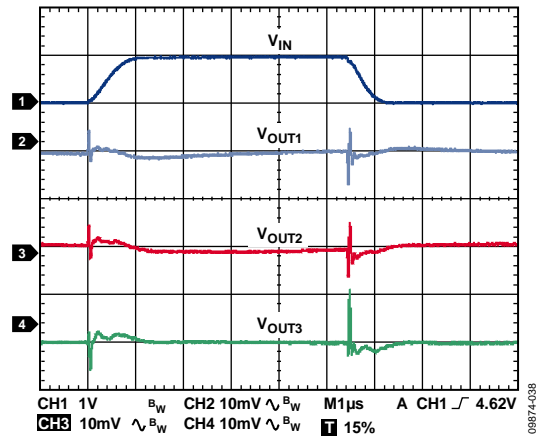

Figure 38. Line Transient Response,  $V_{IN} = 4\text{ V to } 5\text{ V}$ ,  $I_{LOAD1} = I_{LOAD2} = I_{LOAD3} = 100\text{ mA}$ ,  $CH1 = V_{IN}$ ,  $CH2 = V_{OUT1}$ ,  $CH3 = V_{OUT2}$ ,  $CH4 = V_{OUT3}$

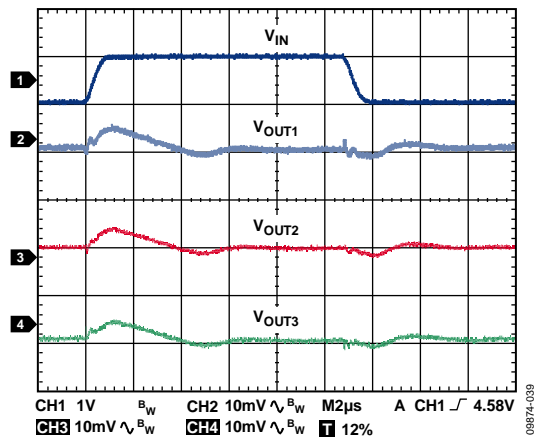

Figure 39. Line Transient Response,  
 $V_{IN} = 4V$  to  $5V$ ,  $I_{LOAD1} = I_{LOAD2} = I_{LOAD3} = 1mA$ ,  
 $CH1 = V_{IN}$ ,  $CH2 = V_{OUT1}$ ,  $CH3 = V_{OUT2}$ ,  $CH4 = V_{OUT3}$

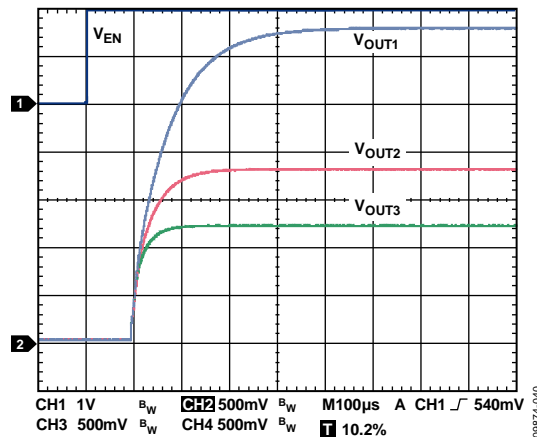

Figure 40. Turn On Response,  
 $I_{LOAD1} = I_{LOAD2} = I_{LOAD3} = 100mA$ ,  
 $CH1 = V_{EN}$ ,  $CH2 = V_{OUT1}$ ,  $CH3 = V_{OUT2}$ ,  $CH4 = V_{OUT3}$

## THEORY OF OPERATION

The ADP320 triple LDO is a low quiescent current, low dropout linear regulator that operates from 1.8 V to 5.5 V on VIN1/VIN2 and VIN3 and provides up to 200 mA of current from each output. Drawing a low 250  $\mu$ A quiescent current (typical) at full load makes the ADP320 triple LDO ideal for battery-operated portable equipment. Shutdown current consumption is typically 100 nA.

Optimized for use with small 1  $\mu$ F ceramic capacitors, the ADP320 triple LDO provides excellent transient performance.

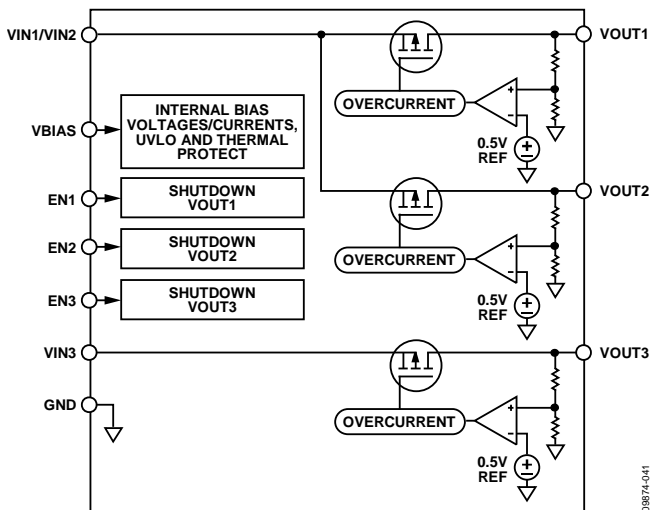

Figure 41. Internal Block Diagram

Internally, the ADP320 triple LDO consist of a reference, three error amplifiers, three feedback voltage dividers, and three PMOS pass transistors. Output current is delivered via the PMOS pass device, which is controlled by the error amplifier. The error amplifier compares the reference voltage with the feedback voltage from the output and amplifies the difference. If the feedback voltage is lower than the reference voltage, the gate of the PMOS device is pulled lower, allowing more current to flow and increasing the output voltage. If the feedback voltage is higher than the reference voltage, the gate of the PMOS device is pulled higher, allowing less current to flow and decreasing the output voltage.

The ADP320 triple LDO is available in multiple output voltage options ranging from 0.8 V to 3.3 V. The ADP320 triple LDO uses the EN1, EN2, and EN3 enable pins to enable and disable the VOUT1/VOUT2/VOUT3 pins under normal operating conditions. When the enable pins are high, VOUT1/VOUT2/VOUT3 turn on; when enable pins are low, VOUT1/VOUT2/VOUT3 turn off. For automatic startup, the enable pins can be tied to VBIAS.

## APPLICATIONS INFORMATION

### CAPACITOR SELECTION

#### Output Capacitor

The ADP320 triple LDO is designed for operation with small, space-saving ceramic capacitors, but the parts function with most commonly used capacitors as long as care is taken in regards to the effective series resistance (ESR) value. The ESR of the output capacitor affects stability of the LDO control loop. A minimum of  $0.70\ \mu\text{F}$  capacitance with an ESR of  $1\ \Omega$  or less is recommended to ensure stability of the ADP320 triple LDO. Transient response to changes in load current is also affected by output capacitance. Using a larger value of output capacitance improves the transient response of the ADP320 triple LDO to large changes in the load current. Figure 42 show the transient response for an output capacitance value of  $1\ \mu\text{F}$ .

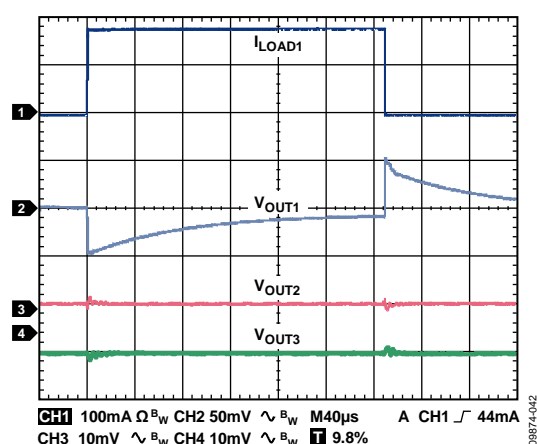

Figure 42. Output Transient Response,  
 $I_{LOAD1} = 1\ \text{mA}$  to  $200\ \text{mA}$ ,  $I_{LOAD2} = 1\ \text{mA}$ ,  $I_{LOAD3} = 1\ \text{mA}$ ,  
 $CH1 = I_{LOAD1}$ ,  $CH2 = V_{OUT1}$ ,  $CH3 = V_{OUT2}$ ,  $CH4 = V_{OUT3}$

#### Input Bypass Capacitor

Connecting a  $1\ \mu\text{F}$  capacitor from VIN1/VIN2, VIN3, and VBIAS to GND reduces the circuit sensitivity to the PCB layout, especially when long input traces or high source impedance are encountered. If an output capacitance greater than  $1\ \mu\text{F}$  is required, the input capacitor should be increased to match it.

#### Input and Output Capacitor Properties

Any good quality ceramic capacitor may be used with the ADP320 triple LDO, as long as the capacitor meets the minimum capacitance and maximum ESR requirements. Ceramic capacitors are manufactured with a variety of dielectrics, each with a different behavior over temperature and applied voltage. Capacitors must have an adequate dielectric to ensure the minimum capacitance over the necessary temperature range and dc bias conditions. X5R or X7R dielectrics with a voltage rating of  $6.3\ \text{V}$  or  $10\ \text{V}$  are recommended. Y5V and Z5U dielectrics are not recommended, due to their poor temperature and dc bias characteristics.

Figure 43 depicts the capacitance vs. voltage bias characteristic of an  $0402\ 1\ \mu\text{F}$ ,  $10\ \text{V}$ , X5R capacitor. The voltage stability of a capacitor is strongly influenced by the capacitor size and voltage rating. In general, a capacitor in a larger package or higher voltage rating exhibits better stability. The temperature variation of the X5R dielectric is about  $\pm 15\%$  over the  $-40^\circ\text{C}$  to  $+85^\circ\text{C}$  temperature range and is not a function of the package or voltage rating.

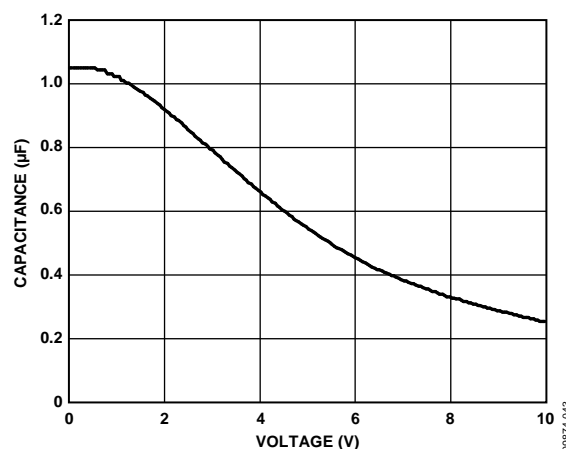

Figure 43. Capacitance vs. Voltage Bias Characteristic

# ADP320

Use Equation 1 to determine the worst-case capacitance accounting for capacitor variation over temperature, component tolerance, and voltage.

$$C_{EFF} = C_{BIAS} \times (1 - TEMP_{CO}) \times (1 - TOL) \quad (1)$$

where:

$C_{BIAS}$  is the effective capacitance at the operating voltage.

$TEMP_{CO}$  is the worst-case capacitor temperature coefficient.

$TOL$  is the worst-case component tolerance.

In this example,  $TEMP_{CO}$  over  $-40^{\circ}\text{C}$  to  $+85^{\circ}\text{C}$  is assumed to be 15% for an X5R dielectric.  $TOL$  is assumed to be 10%, and  $C_{BIAS}$  is  $0.94 \mu\text{F}$  at 1.8 V from the graph in Figure 43.

Substituting these values into Equation 1 yields

$$C_{EFF} = 0.94 \mu\text{F} \times (1 - 0.15) \times (1 - 0.1) = 0.719 \mu\text{F}$$

Therefore, the capacitor chosen in this example meets the minimum capacitance requirement of the LDO over temperature and tolerance at the chosen output voltage.

To guarantee the performance of the ADP320 triple LDO, it is imperative that the effects of dc bias, temperature, and tolerances on the behavior of the capacitors are evaluated for each application.

## UNDERVOLTAGE LOCKOUT

The ADP320 triple LDO has an internal undervoltage lockout circuit that disables all inputs and the output when the input voltage bias,  $V_{BIAS}$ , is less than approximately 2.2 V. This ensures that the inputs of the ADP320 triple LDO and the output behave in a predictable manner during power-up.

## ENABLE FEATURE

The ADP320 triple LDO uses the  $EN_x$  pins to enable and disable the  $V_{OUTx}$  pins under normal operating conditions. Figure 44 shows a rising voltage on  $EN$  crossing the active threshold, then  $V_{OUTx}$  turns on. When a falling voltage on  $EN_x$  crosses the inactive threshold,  $V_{OUTx}$  turns off.

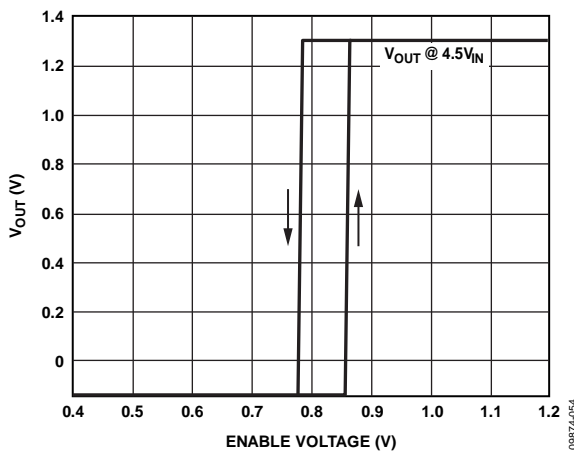

Figure 44. Typical  $EN_x$  Pin Operation

As shown in Figure 44, the  $EN_x$  pin has built-in hysteresis. This prevents on/off oscillations that can occur due to noise on the  $EN_x$  pin as it passes through the threshold points.

The active/inactive thresholds of the  $EN_x$  pin are derived from the  $V_{BIAS}$  voltage. Therefore, these thresholds vary with changing input voltage. Figure 45 shows typical  $EN_x$  active/inactive thresholds when the input voltage varies from 2.5 V to 5.5 V.

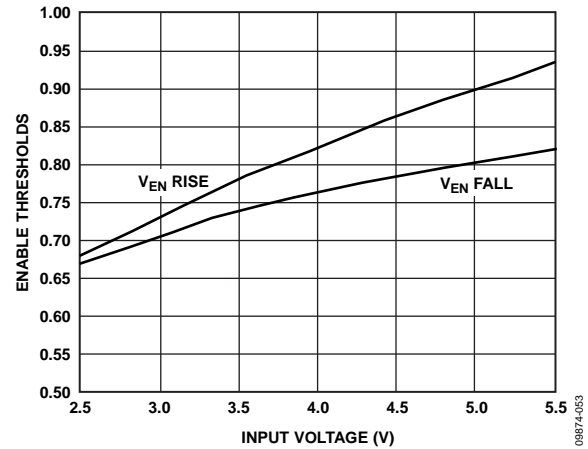

Figure 45. Typical  $EN_x$  Pins Thresholds vs. Input Voltage

The ADP320 triple LDO utilizes an internal soft start to limit the inrush current when the output is enabled. The start-up time for the 2.8 V option is approximately 220  $\mu\text{s}$  from the time the  $EN_x$  active threshold is crossed to when the output reaches 90% of its final value. The start-up time is somewhat dependent on the output voltage setting and increases slightly as the output voltage increases.

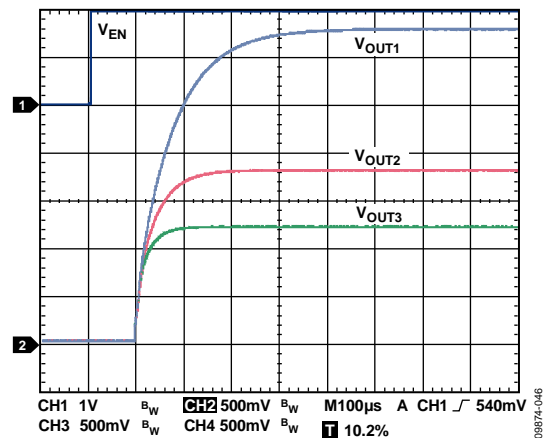

Figure 46. Typical Start-Up Time,  
 $I_{LOAD1} = I_{LOAD2} = I_{LOAD3} = 100 \text{ mA}$ ,  
 $CH1 = V_{EN}$ ,  $CH2 = V_{OUT1}$ ,  $CH3 = V_{OUT2}$ ,  $CH4 = V_{OUT3}$



## CURRENT-LIMIT AND THERMAL OVERLOAD PROTECTION

The ADP320 triple LDO is protected against damage due to excessive power dissipation by current and thermal overload protection circuits. The ADP320 triple LDO is designed to current limit when the output load reaches 300 mA (typical). When the output load exceeds 300 mA, the output voltage is reduced to maintain a constant current limit.

Thermal overload protection is built-in, which limits the junction temperature to a maximum of 155°C (typical). Under extreme conditions (that is, high ambient temperature and power dissipation) when the junction temperature starts to rise above 155°C, the output is turned off, reducing the output current to zero. When the junction temperature drops below 140°C, the output is turned on again and the output current is restored to its nominal value.

Consider the case where a hard short from VOUTx to GND occurs. At first, the ADP320 triple LDO current limits, so that only 300 mA is conducted into the short. If self-heating of the junction is great enough to cause its temperature to rise above 155°C, thermal shutdown activates turning off the output and reducing the output current to zero. As the junction temperature cools and drops below 140°C, the output turns on and conducts 300 mA into the short, again causing the junction temperature to rise above 155°C. This thermal oscillation between 140°C and 154°C causes a current oscillation between 0 mA and 300 mA that continues as long as the short remains at the output.

Current and thermal limit protections are intended to protect the device against accidental overload conditions. For reliable operation, device power dissipation must be externally limited so junction temperatures do not exceed 125°C.

## THERMAL CONSIDERATIONS

In most applications, the ADP320 triple LDO does not dissipate a lot of heat due to high efficiency. However, in applications with a high ambient temperature and high supply voltage to output voltage differential, the heat dissipated in the package is large enough that it can cause the junction temperature of the die to exceed the maximum junction temperature of 125°C.

When the junction temperature exceeds 155°C, the converter enters thermal shutdown. It recovers only after the junction temperature has decreased below 140°C to prevent any permanent damage. Therefore, thermal analysis for the chosen application is very important to guarantee reliable performance over all conditions. The junction temperature of the die is the sum of the ambient temperature of the environment and the temperature rise of the package due to the power dissipation, as shown in Equation 2.

To guarantee reliable operation, the junction temperature of the ADP320 triple LDO must not exceed 125°C. To ensure that the junction temperature stays below this maximum value, the user needs to be aware of the parameters that contribute to junction temperature changes. These parameters include ambient temperature, power dissipation in the power device, and thermal resistances between the junction and ambient air ( $\theta_{JA}$ ). The  $\theta_{JA}$  number is dependent on the package assembly compounds used and the amount of copper to which the GND pins of the package are soldered on the PCB. Table 6 shows typical  $\theta_{JA}$  values for the ADP320 triple LDO for various PCB copper sizes.

**Table 6. Typical  $\theta_{JA}$  Values**

| Copper Size (mm <sup>2</sup> ) | ADP320 Triple LDO (°C/W) |
|--------------------------------|--------------------------|
| JEDEC <sup>1</sup>             | 49.5                     |
| 100                            | 83.7                     |
| 500                            | 68.5                     |
| 1000                           | 64.7                     |

<sup>1</sup> Device soldered to JEDEC standard board.

The junction temperature of the ADP320 triple LDO can be calculated from the following equation:

$$T_J = T_A + (P_D \times \theta_{JA}) \quad (2)$$

where:

$T_A$  is the ambient temperature.

$P_D$  is the power dissipation in the die, given by

$$P_D = \Sigma[(V_{IN} - V_{OUT}) \times I_{LOAD}] + \Sigma(V_{IN} \times I_{GND}) \quad (3)$$

where:

$I_{LOAD}$  is the load current.

$I_{GND}$  is the ground current.

$V_{IN}$  and  $V_{OUT}$  are input and output voltages, respectively.

Power dissipation due to ground current is quite small and can be ignored. Therefore, the junction temperature equation simplifies to

$$T_J = T_A + \{\Sigma[(V_{IN} - V_{OUT}) \times I_{LOAD}] \times \theta_{JA}\} \quad (4)$$

As shown in Equation 4, for a given ambient temperature, input-to-output voltage differential, and continuous load current, there exists a minimum copper size requirement for the PCB to ensure the junction temperature does not rise above 125°C. Figure 47 to Figure 50 show junction temperature calculations for different ambient temperatures, total power dissipation, and areas of PCB copper.

In cases where the board temperature is known, the thermal characterization parameter,  $\Psi_{JB}$ , may be used to estimate the junction temperature rise.  $T_J$  is calculated from  $T_B$  and  $P_D$  using the formula

$$T_J = T_B + (P_D \times \Psi_{JB}) \quad (5)$$

The typical  $\Psi_{JB}$  value for the 16-lead 3 mm × 3 mm LFCSP is 25.2°C/W.

# ADP320

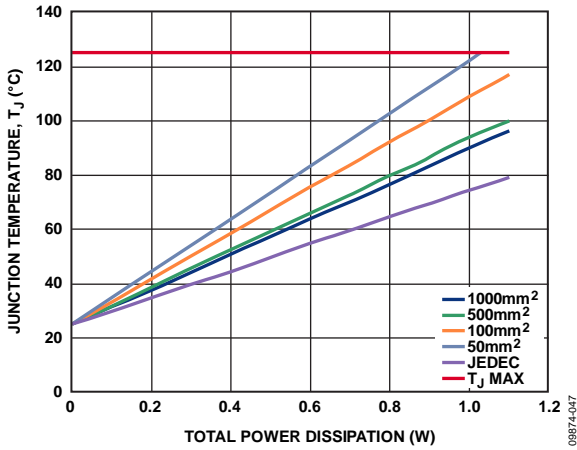

Figure 47. Junction Temperature vs. Total Power Dissipation,  $T_A = 25^\circ\text{C}$

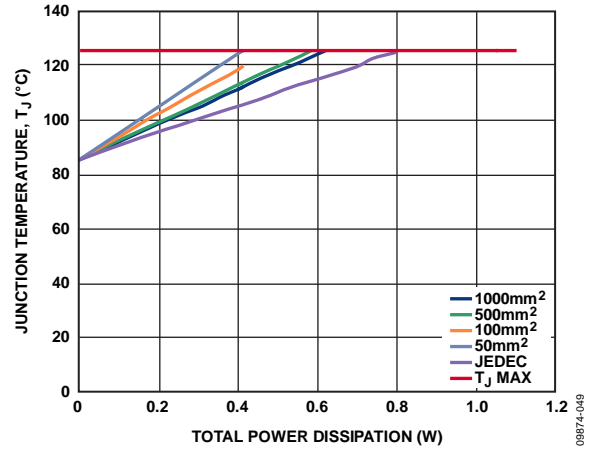

Figure 49. Junction Temperature vs. Total Power Dissipation,  $T_A = 85^\circ\text{C}$

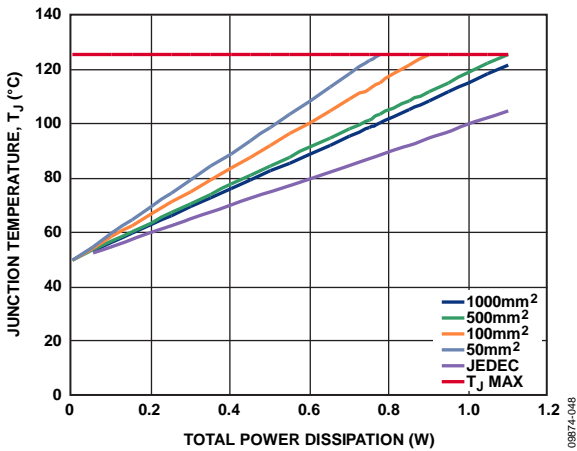

Figure 48. Junction Temperature vs. Total Power Dissipation,  $T_A = 50^\circ\text{C}$

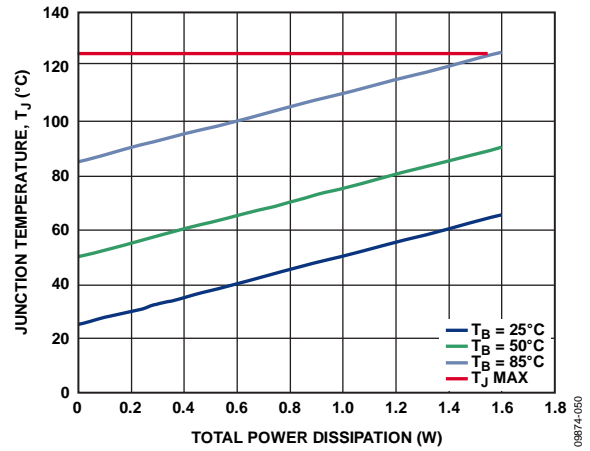

Figure 50. Junction Temperature vs. Total Power Dissipation and Board Temperature

## PRINTED CIRCUIT BOARD LAYOUT CONSIDERATIONS

Heat dissipation from the package can be improved by increasing the amount of copper attached to the pins of the ADP320 triple LDO. However, as can be seen from Table 6, a point of diminishing returns eventually is reached, beyond which an increase in the copper size does not yield significant heat dissipation benefits.

Place the input capacitor as close as possible to the VINx and GND pins. Place the output capacitors as close as possible to the VOUTx and GND pins. Use 0402 or 0603 size capacitors and resistors to achieve the smallest possible footprint solution on boards where area is limited.

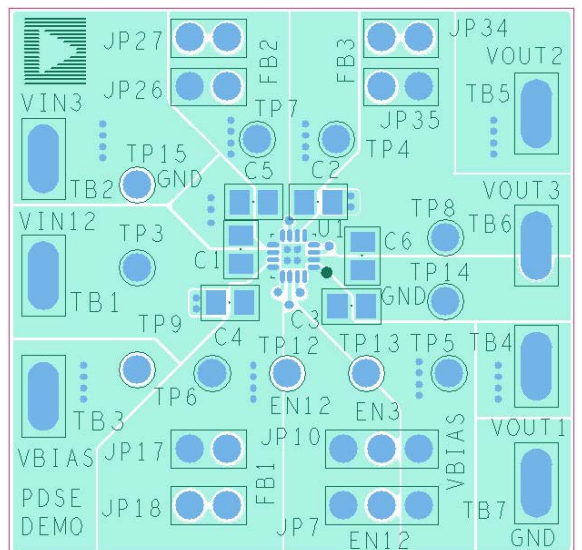

Figure 51. Example of PCB Layout, Top Side

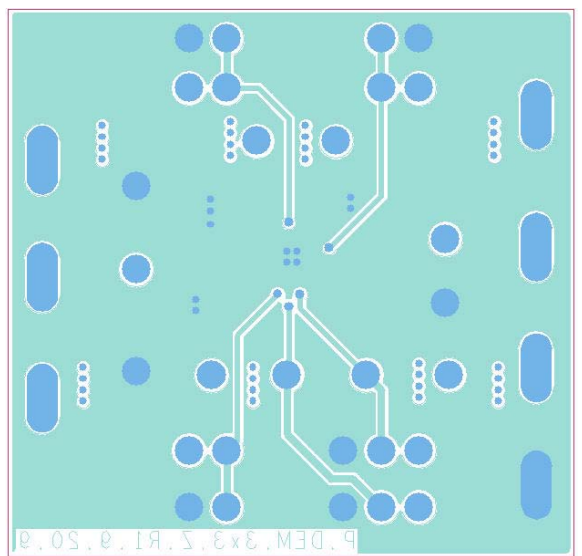
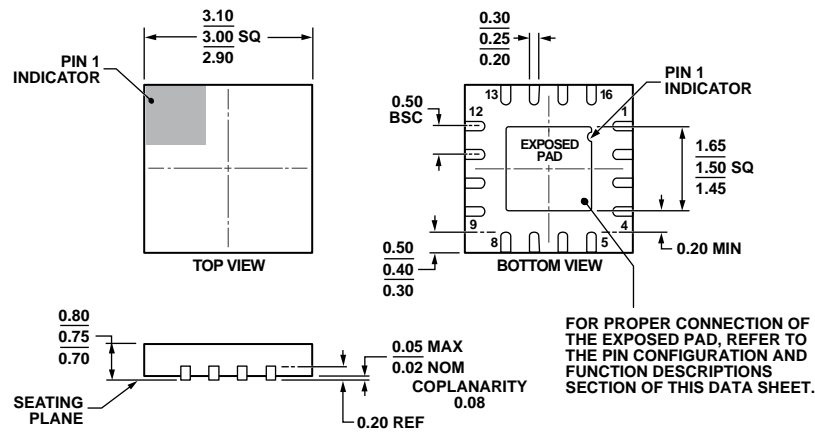

Figure 52. Example of PCB Layout, Bottom Side

# ADP320

## OUTLINE DIMENSIONS



COMPLIANT TO JEDEC STANDARDS MO-229.

Figure 53. 16-Lead Lead Frame Chip Scale Package [LFCSP\_WQ]  
 3 mm × 3 mm Body, Very, Very Thin Quad  
 (CP-16-27)  
 Dimensions shown in millimeters

091605-A

## ORDERING GUIDE

| Model <sup>1</sup> | Temperature Range | Output Voltage (V) <sup>2</sup> | Package Description | Package Option | Branding |
|--------------------|-------------------|---------------------------------|---------------------|----------------|----------|
| ADP320ACPZ331815R7 | -40°C to +125°C   | 3.3, 1.8, 1.5                   | 16-Lead LFCSP_WQ    | CP-16-27       | LGP      |
| ADP320ACPZ-110-R7  | -40°C to +125°C   | 3.3, 3.3, 1.5                   | 16-Lead LFCSP_WQ    | CP-16-27       | L15      |

<sup>1</sup> Z = RoHS Compliant Part.

<sup>2</sup> For additional voltage options, contact a local sales or distribution representative.