

### FEATURES

- Low offset voltage: 150  $\mu\text{V}$  max**
- Input offset drift: 1.5  $\mu\text{V}/^\circ\text{C}$  max**
- Low noise: 0.25  $\mu\text{V}$  p-p**
- High gain CMRR and PSRR: 115 dB min**
- Low supply current: 1.1 mA**
- Wide supply voltage range:  $\pm 4\text{ V}$  to  $\pm 18\text{ V}$  operation**

### APPLICATIONS

- Medical and industrial instrumentation**
- Sensors and controls**
  - Thermocouple**
  - RTDs**
  - Strain bridges**
  - Shunt current measurements**
- Precision filters**

### GENERAL DESCRIPTION

The OP07D is a precision, ultralow offset amplifier. It integrates low power (1.1 mA typical), low input bias current ( $\pm 1\text{ nA}$  maximum), and high CMRR/PSRR (130 dB) in the small DIP package. Operation is fully specified from  $\pm 5\text{ V}$  to  $\pm 15\text{ V}$  supply.

The OP07D provides higher accuracy than industry-standard OP07-type amplifiers due to Analog Devices' iPolar™ process, which supports enhanced performance in a smaller footprint. These performance enhancements include wider output swing, lower power, and higher CMRR (common-mode rejection ratio) and PSRR (power supply rejection ratio). The OP07D maintains stability of offsets and gain virtually regardless of variations in time or temperature. Excellent linearity and gain accuracy can be maintained at high closed-loop gains.

The OP07D is fully specified over the extended industrial temperature range of  $-40^\circ\text{C}$  to  $+125^\circ\text{C}$ . The OP07D amplifier is available in 8-lead DIP and the popular 8-lead, narrow SOIC lead-free packages.

### PIN CONFIGURATIONS

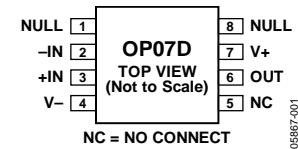

Figure 1. 8-Lead SOIC\_N (R-8), 8-Lead DIP (N-8)

#### Rev. A

Information furnished by Analog Devices is believed to be accurate and reliable. However, no responsibility is assumed by Analog Devices for its use, nor for any infringements of patents or other rights of third parties that may result from its use. Specifications subject to change without notice. No license is granted by implication or otherwise under any patent or patent rights of Analog Devices. Trademarks and registered trademarks are the property of their respective owners.

One Technology Way, P.O. Box 9106, Norwood, MA 02062-9106, U.S.A.  
 Tel: 781.329.4700 [www.analog.com](http://www.analog.com)  
 Fax: 781.461.3113 © 2005–2011 Analog Devices, Inc. All rights reserved.

## TABLE OF CONTENTS

|                           |   |   |    |
|---------------------------|---|---|----|
| Features .....            | 1 | Absolute Maximum Ratings .....            | 5  |
| Applications.....         | 1 | Thermal Resistance .....                  | 5  |
| General Description ..... | 1 | ESD Caution.....                          | 5  |
| Pin Configurations .....  | 1 | Typical Performance Characteristics ..... | 6  |
| Revision History .....    | 2 | Outline Dimensions .....                  | 13 |
| Specifications.....       | 3 | Ordering Guide .....                      | 14 |

## REVISION HISTORY

### 2/11—Rev. 0 to Rev. A

|  |    |
|--|----|
| Changes to Output Voltage Swing Parameter..... | 4  |
| Changes to Figure 42.....                      | 12 |
| Updated Outline Dimensions .....               | 13 |
| Changes to Ordering Guide .....                | 14 |

### 12/05—Revision 0: Initial Version

## SPECIFICATIONS

$V_S = \pm 5.0\text{ V}$ ,  $T_A = 25^\circ\text{C}$ , unless otherwise specified.

Table 1.

| Parameter                    | Symbol                   | Test Conditions/Comments                                   | Min        | Typ       | Max  | Unit                         |
|------------------------------|--------------------------|--|------------|-----------|------|------------------------------|
| INPUT CHARACTERISTICS        |                          |  |            |           |      |                              |
| Offset Voltage               | $V_{OS}$                 | $0^\circ\text{C} \leq T_A \leq 70^\circ\text{C}$           |            | 40        | 150  | $\mu\text{V}$                |
|                              |                          | $-40^\circ\text{C} \leq T_A \leq +125^\circ\text{C}$       |            |           | 250  | $\mu\text{V}$                |
|                              |                          |  |            |           | 350  | $\mu\text{V}$                |
| Input Bias Current           | $I_B$                    | $-40^\circ\text{C} \leq T_A \leq +125^\circ\text{C}$       |            | 0.2       | 1    | nA                           |
| Input Offset Current         | $I_{OS}$                 | $-40^\circ\text{C} \leq T_A \leq +125^\circ\text{C}$       |            | 0.1       | 1    | nA                           |
| Input Voltage Range          |                          |  | -3.5       |           | +3.5 | V                            |
| Common-Mode Rejection Ratio  | CMRR                     | $V_{CM} = \pm 3\text{ V}$                                  | 120        | 127       |      | dB                           |
|                              |                          | $-40^\circ\text{C} \leq T_A \leq +125^\circ\text{C}$       | 120        |           |      | dB                           |
| Open-Loop Gain               | $A_{VO}$                 | $R_L = 2\text{ k}\Omega$ to ground, $V_O = \pm 3\text{ V}$ | 1000       | 10,000    |      | V/mV                         |
|                              |                          | $-40^\circ\text{C} \leq T_A \leq +125^\circ\text{C}$       | 1000       |           |      | V/mV                         |
| Offset Voltage Drift         | $\Delta V_{OS}/\Delta T$ | $0^\circ\text{C} \leq T_A \leq 70^\circ\text{C}$           |            | 0.5       | 1.8  | $\mu\text{V}/^\circ\text{C}$ |
|                              |                          | $-40^\circ\text{C} \leq T_A \leq +125^\circ\text{C}$       |            | 0.5       | 1.4  | $\mu\text{V}/^\circ\text{C}$ |
| OUTPUT CHARACTERISTICS       |                          |  |            |           |      |                              |
| Output Voltage Swing         | $V_{OUT}$                | $R_L = 10\text{ k}\Omega$ to ground                        | $\pm 3.95$ | $\pm 4.1$ |      | V                            |
|                              |                          | $-40^\circ\text{C} \leq T_A \leq +125^\circ\text{C}$       | $\pm 3.95$ |           |      | V                            |
|                              |                          | $R_L = 2\text{ k}\Omega$ to ground                         | $\pm 3.9$  | $\pm 4$   |      | V                            |
|                              |                          | $-40^\circ\text{C} \leq T_A \leq +125^\circ\text{C}$       | $\pm 3.9$  |           |      | V                            |
| Short-Circuit Current        | $I_{SC}$                 |  |            | 27        |      | mA                           |
| Output Current               | $I_O$                    | $V_O = 3.5\text{ V}$                                       |            | 15        |      | mA                           |
| POWER SUPPLY                 |                          |  |            |           |      |                              |
| Power Supply Rejection Ratio | PSRR                     | $V_S = \pm 4.0\text{ V}$ to $\pm 18.0\text{ V}$            | 115        | 130       |      | dB                           |
|                              |                          | $0^\circ\text{C} \leq T_A \leq 70^\circ\text{C}$           | 115        |           |      | dB                           |
|                              |                          | $-40^\circ\text{C} \leq T_A \leq +125^\circ\text{C}$       | 110        |           |      | dB                           |
| Supply Current/Amplifier     | $I_{SY}$                 | $V_O = 0\text{ V}$   |            | 1.1       | 1.25 | mA                           |
|                              |                          | $0^\circ\text{C} \leq T_A \leq 70^\circ\text{C}$           |            |           | 1.45 | mA                           |
|                              |                          | $-40^\circ\text{C} \leq T_A \leq +125^\circ\text{C}$       |            |           | 1.75 | mA                           |
| DYNAMIC PERFORMANCE          |                          |  |            |           |      |                              |
| Slew Rate                    | SR                       | $R_L = 10\text{ k}\Omega$                                  |            | 0.2       |      | V/ $\mu\text{s}$             |
| Gain Bandwidth Product       | GBP                      |  |            | 0.6       |      | MHz                          |
| Phase Margin                 |                          |  |            | 80        |      | Degrees                      |
| NOISE PERFORMANCE            |                          |  |            |           |      |                              |
| Voltage Noise                | $e_{n\text{ p-p}}$       | 0.1 Hz to 10 Hz  |            | 0.28      |      | $\mu\text{V p-p}$            |
| Voltage Noise Density        | $e_n$                    | $f = 1\text{ kHz}$   |            | 10        |      | nV/ $\sqrt{\text{Hz}}$       |
| Current Noise Density        | $i_n$                    | $f = 1\text{ kHz}$   |            | 0.074     |      | pA/ $\sqrt{\text{Hz}}$       |

# OP07D

$V_s = \pm 15\text{ V}$ ,  $T_A = 25^\circ\text{C}$ , unless otherwise specified.

**Table 2.**

| Parameter                     | Symbol                   | Test Conditions/Comments  | Min  | Typ                        | Max                 | Unit   |
|-------------------------------|--------------------------|---|--|----------------------------|---------------------|--|
| <b>INPUT CHARACTERISTICS</b>  |                          |   |  |                            |                     |  |
| Offset Voltage                | $V_{OS}$                 | $0^\circ\text{C} \leq T_A \leq 70^\circ\text{C}$<br>$-40^\circ\text{C} \leq T_A \leq +125^\circ\text{C}$  |  | 45                         | 150<br>250<br>350   | $\mu\text{V}$<br>$\mu\text{V}$<br>$\mu\text{V}$              |
| Input Bias Current            | $I_B$                    | $-40^\circ\text{C} \leq T_A \leq +125^\circ\text{C}$  |  | 0.2                        | 1                   | nA   |
| Input Offset Current          | $I_{OS}$                 | $-40^\circ\text{C} \leq T_A \leq +125^\circ\text{C}$  |  | 0.2                        | 1<br>1              | nA<br>nA   |
| Input Voltage Range           |                          |   | -13.5  |                            | +13.5               | V  |
| Common-Mode Rejection Ratio   | CMRR                     | $V_{CM} = \pm 13.0\text{ V}$<br>$-40^\circ\text{C} \leq T_A \leq +125^\circ\text{C}$  | 120  | 140                        |                     | dB<br>dB   |
| Open-Loop Gain                | $A_{VO}$                 | $R_L = 2\text{ k}\Omega$ to ground, $V_O = \pm 11\text{ V}$<br>$-40^\circ\text{C} \leq T_A \leq +125^\circ\text{C}$   | 1000   | 10,000                     |                     | V/mV<br>V/mV   |
| Offset Voltage Drift          | $\Delta V_{OS}/\Delta T$ | $0^\circ\text{C} \leq T_A \leq 70^\circ\text{C}$<br>$-40^\circ\text{C} \leq T_A \leq +125^\circ\text{C}$  |  | 0.5                        | 2.5<br>1.5          | $\mu\text{V}/^\circ\text{C}$<br>$\mu\text{V}/^\circ\text{C}$ |
| <b>OUTPUT CHARACTERISTICS</b> |                          |   |  |                            |                     |  |
| Output Voltage Swing          | $V_{OUT}$                | $R_L = 10\text{ k}\Omega$ to ground<br>$-40^\circ\text{C} \leq T_A \leq +125^\circ\text{C}$<br>$R_L = 2\text{ k}\Omega$ to ground<br>$-40^\circ\text{C} \leq T_A \leq +125^\circ\text{C}$ | $\pm 13.95$<br>$\pm 13.9$<br>$\pm 13.75$<br>$\pm 13.7$ | $\pm 14$<br><br>$\pm 13.8$ |                     | V<br>V<br>V<br>V   |
| Short-Circuit Current         | $I_{SC}$                 |   |  | 30                         |                     | mA   |
| Output Current                | $I_O$                    | $V_O = 13.5\text{ V}$   |  | 15                         |                     | mA   |
| <b>POWER SUPPLY</b>           |                          |   |  |                            |                     |  |
| Power Supply Rejection Ratio  | PSRR                     | $V_s = \pm 4.0\text{ V}$ to $\pm 18.0\text{ V}$<br>$0^\circ\text{C} \leq T_A \leq 70^\circ\text{C}$<br>$-40^\circ\text{C} \leq T_A \leq +125^\circ\text{C}$                               | 115<br>115<br>110                                      | 130                        |                     | dB<br>dB<br>dB   |
| Supply Current/Amplifier      | $I_{SV}$                 | $V_O = 0\text{ V}$<br>$0^\circ\text{C} \leq T_A \leq 70^\circ\text{C}$<br>$-40^\circ\text{C} \leq T_A \leq +125^\circ\text{C}$  |  | 1.1                        | 1.3<br>1.55<br>1.85 | mA<br>mA<br>mA   |
| <b>DYNAMIC PERFORMANCE</b>    |                          |   |  |                            |                     |  |
| Slew Rate                     | SR                       | $R_L = 10\text{ k}\Omega$   |  | 0.2                        |                     | V/ $\mu\text{s}$   |
| Gain Bandwidth Product        | GBP                      |   |  | 0.6                        |                     | MHz  |
| Phase Margin                  |                          |   |  | 80                         |                     | Degrees  |
| <b>NOISE PERFORMANCE</b>      |                          |   |  |                            |                     |  |
| Voltage Noise                 | $e_{n\text{ p-p}}$       | 0.1 Hz to 10 Hz   |  | 0.25                       |                     | $\mu\text{V p-p}$  |
| Voltage Noise Density         | $e_n$                    | $f = 1\text{ kHz}$  |  | 10                         |                     | nV/ $\sqrt{\text{Hz}}$                                       |
| Current Noise Density         | $i_n$                    | $f = 1\text{ kHz}$  |  | 0.074                      |                     | pA/ $\sqrt{\text{Hz}}$                                       |

## ABSOLUTE MAXIMUM RATINGS

Table 3.

| Parameter                            | Rating          |
|--------------------------------------|-----------------|
| Supply Voltage                       | ±18 V           |
| Input Voltage                        | ±V supply       |
| Differential Input Voltage           | ±0.7 V          |
| Output Short-Circuit Duration to GND | Indefinite      |
| Storage Temperature Range            | −65°C to +150°C |
| Operating Temperature Range          | −40°C to +125°C |
| Junction Temperature Range           | −65°C to +150°C |
| Lead Temperature (Soldering, 10 sec) | +300°C          |

Stresses above those listed under Absolute Maximum Ratings may cause permanent damage to the device. This is a stress rating only; functional operation of the device at these or any other conditions above those indicated in the operational section of this specification is not implied. Exposure to absolute maximum rating conditions for extended periods may affect device reliability.

### THERMAL RESISTANCE

$\theta_{JA}$  is specified for worst-case conditions, that is, a device soldered in a circuit board for surface-mount packages.

Table 4.

| Package Type      | $\theta_{JA}$ | $\theta_{JC}$ | Unit |
|-------------------|---------------|---------------|------|
| 8-Lead DIP (N-8)  | 103           | 43            | °C/W |
| 8-Lead SOIC (R-8) | 158           | 43            | °C/W |

### ESD CAUTION

ESD (electrostatic discharge) sensitive device. Electrostatic charges as high as 4000 V readily accumulate on the human body and test equipment and can discharge without detection. Although this product features proprietary ESD protection circuitry, permanent damage may occur on devices subjected to high energy electrostatic discharges. Therefore, proper ESD precautions are recommended to avoid performance degradation or loss of functionality.



TYPICAL PERFORMANCE CHARACTERISTICS

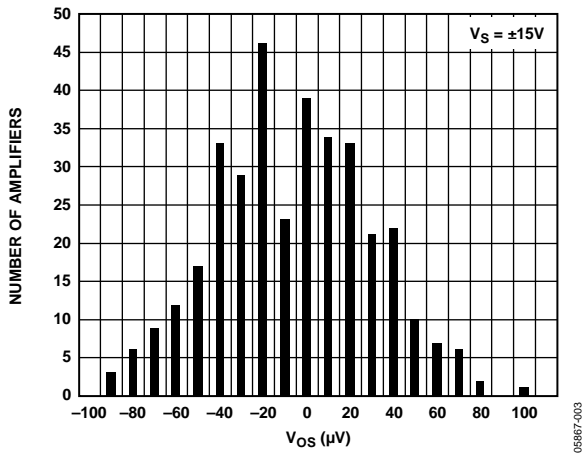

Figure 2. Number of Amplifiers vs. Offset Voltage

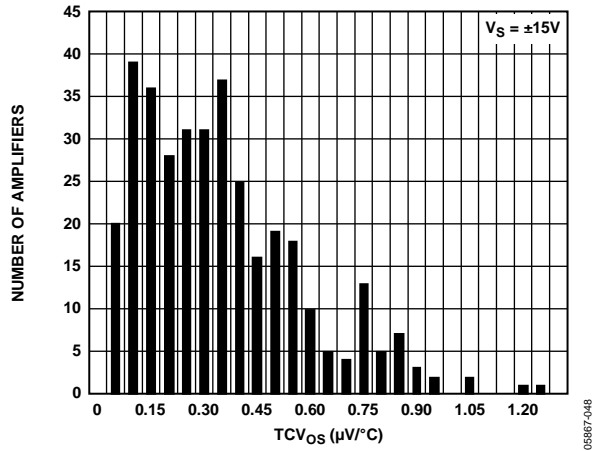

Figure 5. Number of Amplifiers vs.  $TCV_{OS}$

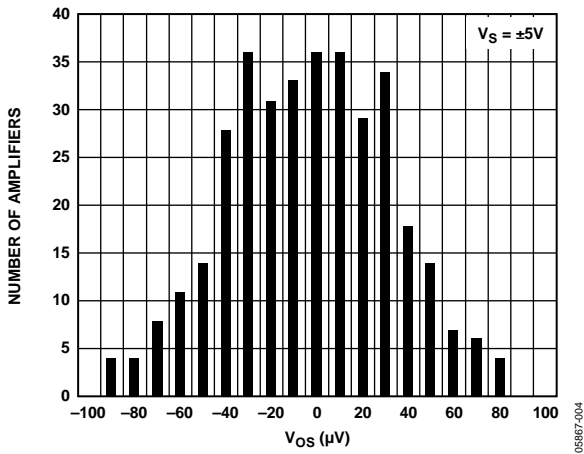

Figure 3. Number of Amplifiers vs. Offset Voltage

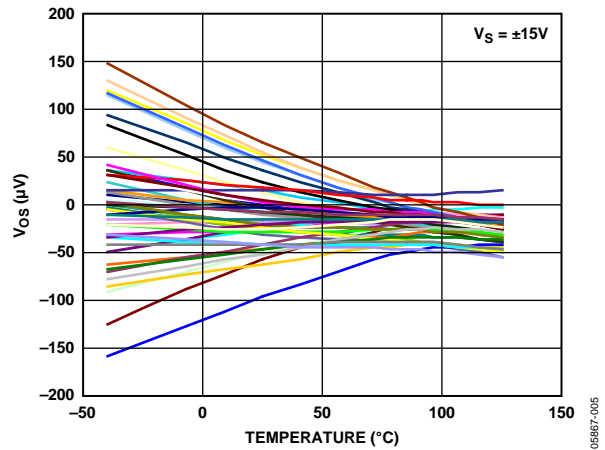

Figure 6. Offset Voltage vs. Temperature

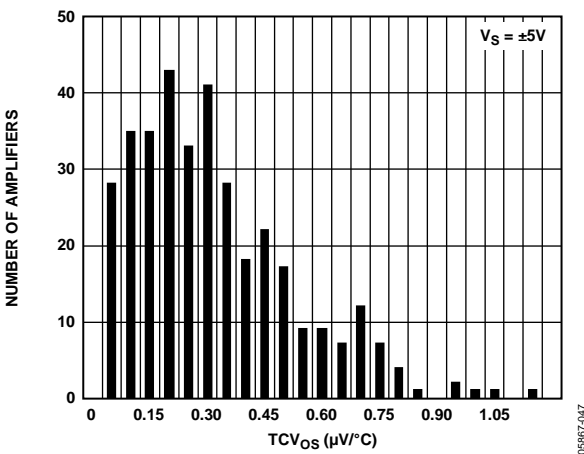

Figure 4. Number of Amplifiers vs.  $TCV_{OS}$

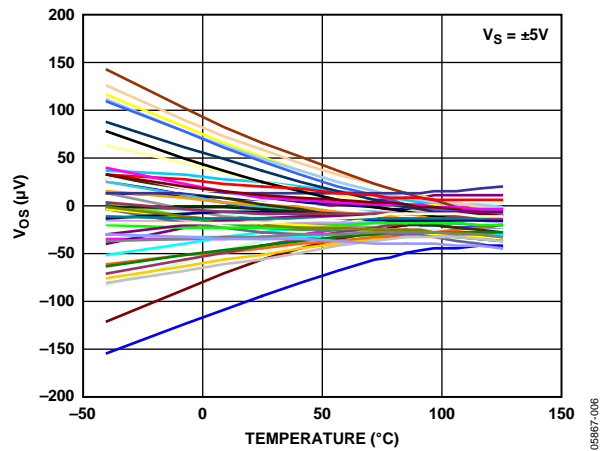

Figure 7. Offset Voltage vs. Temperature

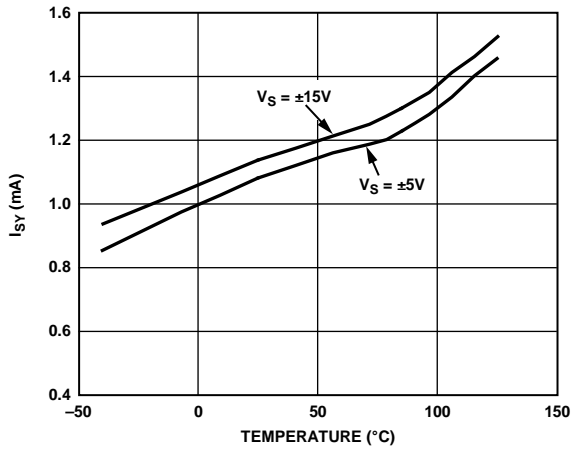

Figure 8. Supply Current vs. Temperature

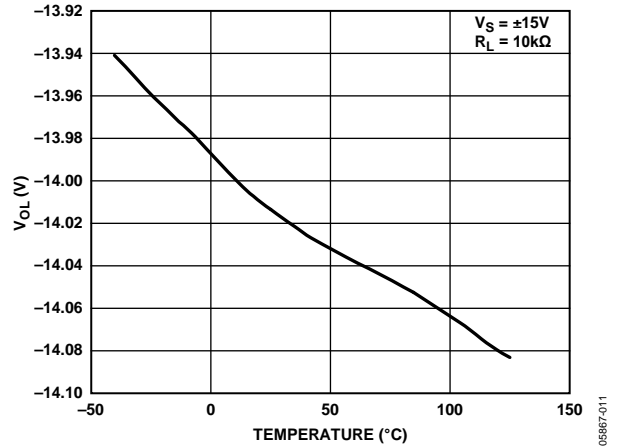

Figure 11. Negative Output Voltage Swing vs. Temperature

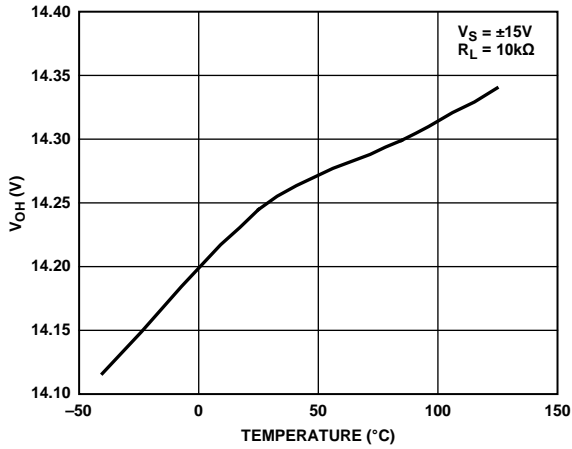

Figure 9. Positive Output Voltage Swing vs. Temperature

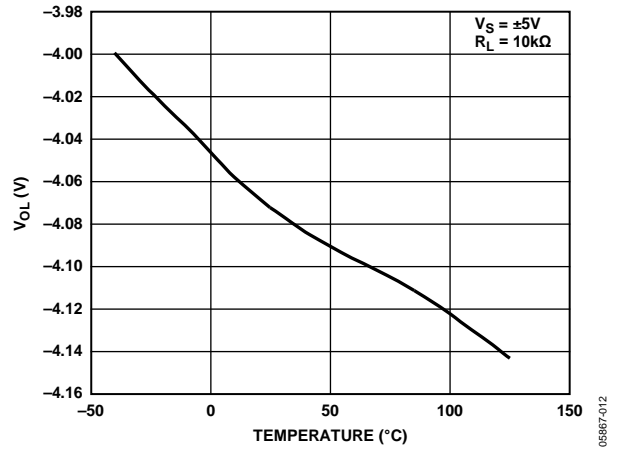

Figure 12. Negative Output Voltage Swing vs. Temperature

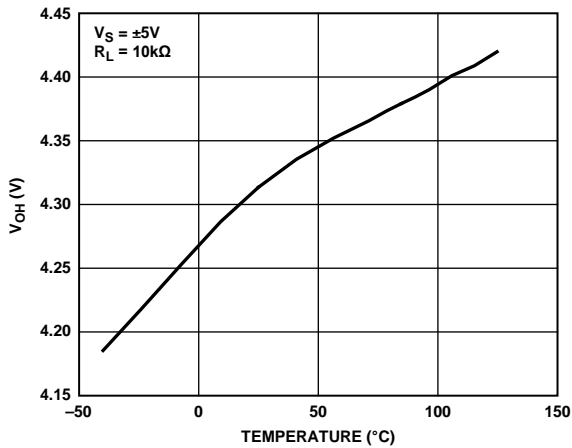

Figure 10. Positive Output Voltage Swing vs. Temperature

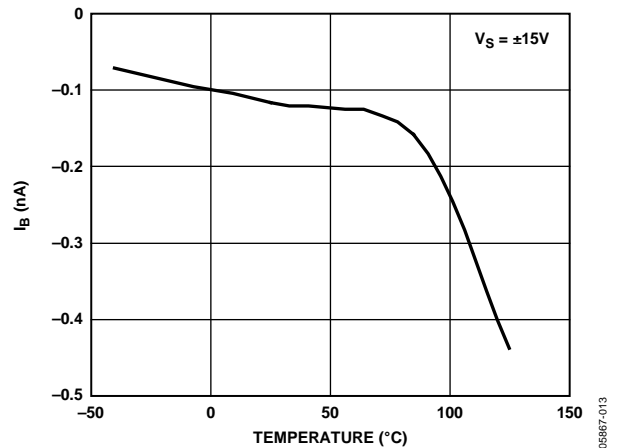

Figure 13. Input Bias Current vs. Temperature

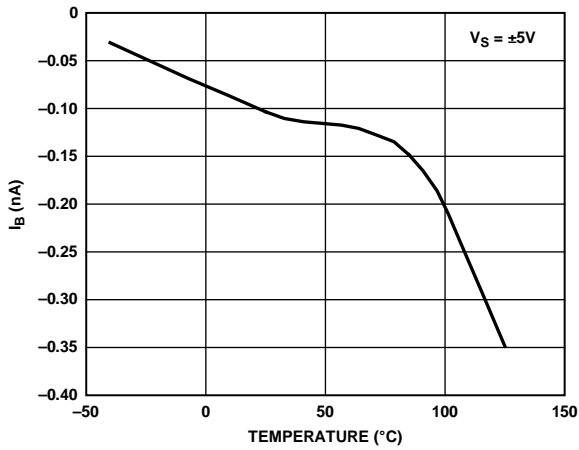

Figure 14. Input Bias Current vs. Temperature

05867-014

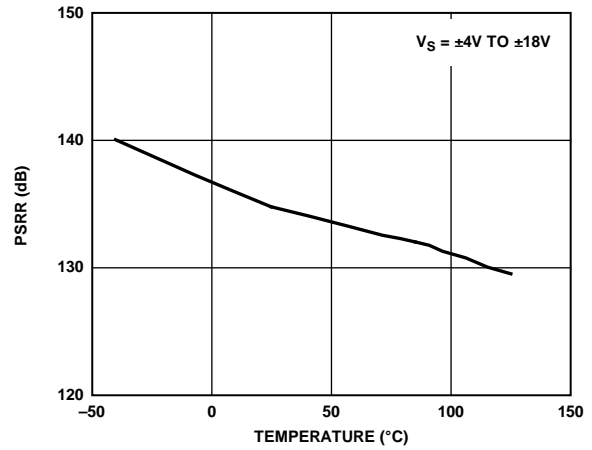

Figure 17. PSRR vs. Temperature

05867-019

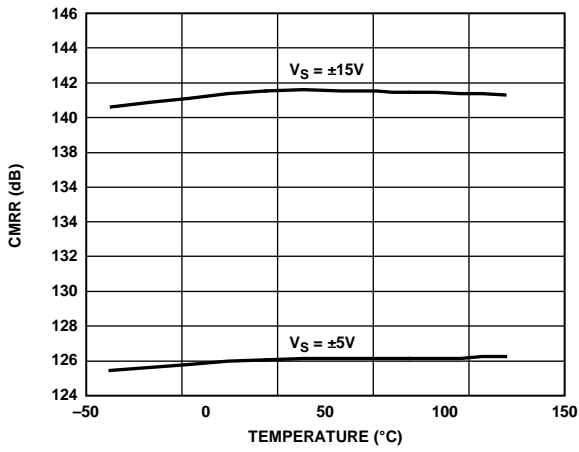

Figure 15. CMRR vs. Temperature

05867-015

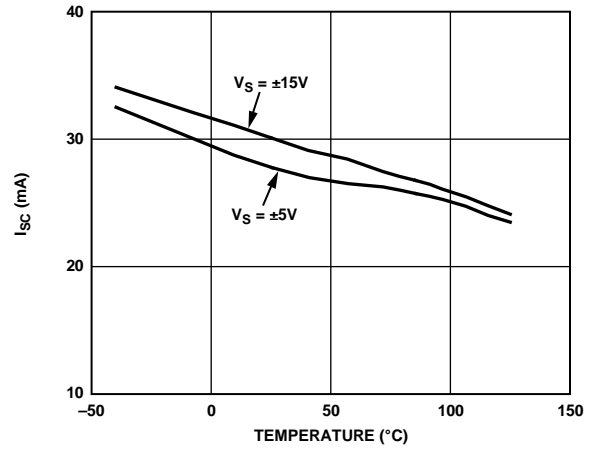

Figure 18. Short-Circuit Current vs. Temperature

05867-020

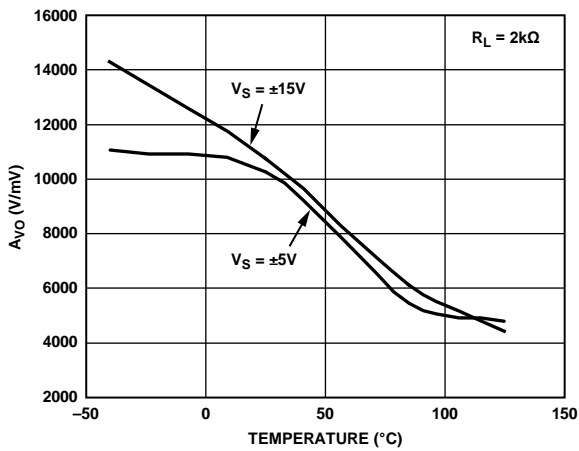

Figure 16. Open-Loop Gain vs. Temperature

05867-017

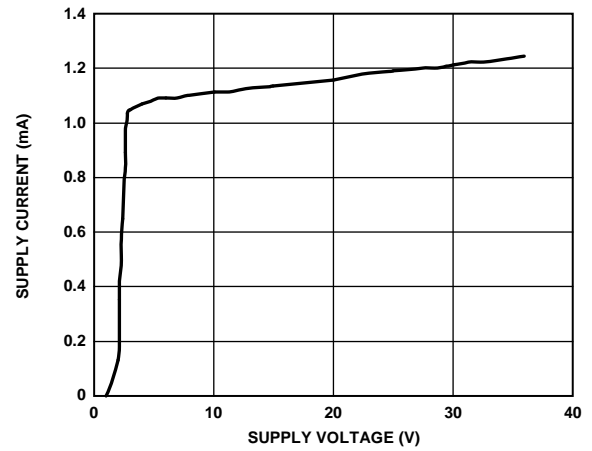

Figure 19. Supply Current vs. Supply Voltage

05867-022



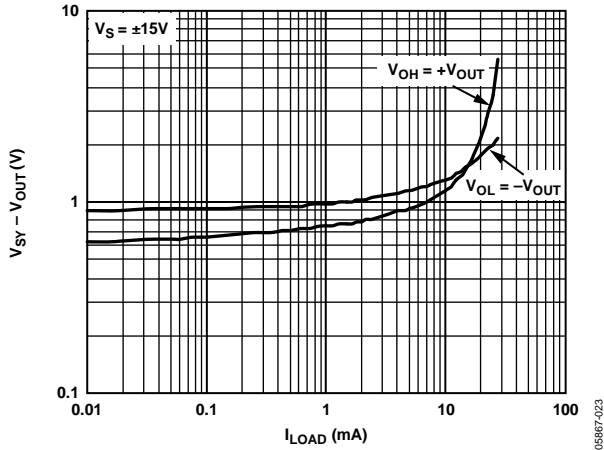

Figure 20. Output Voltage Swing vs. Load Current

05867-023

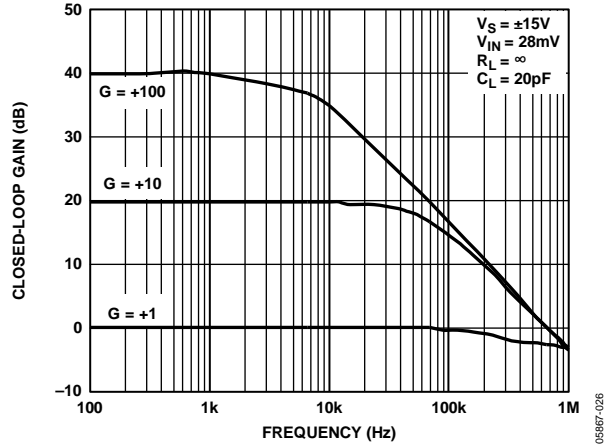

Figure 23. Closed-Loop Gain vs. Frequency

05867-026

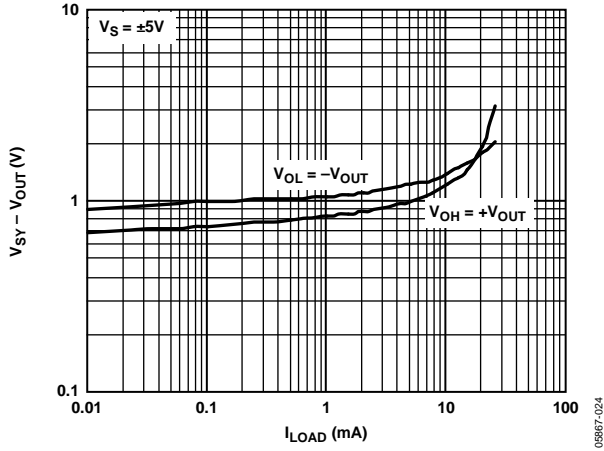

Figure 21. Output Voltage Swing vs. Load Current

05867-024

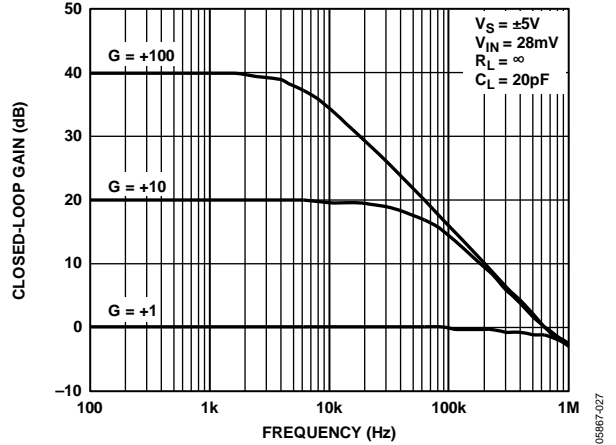

Figure 24. Closed-Loop Gain vs. Frequency

05867-027

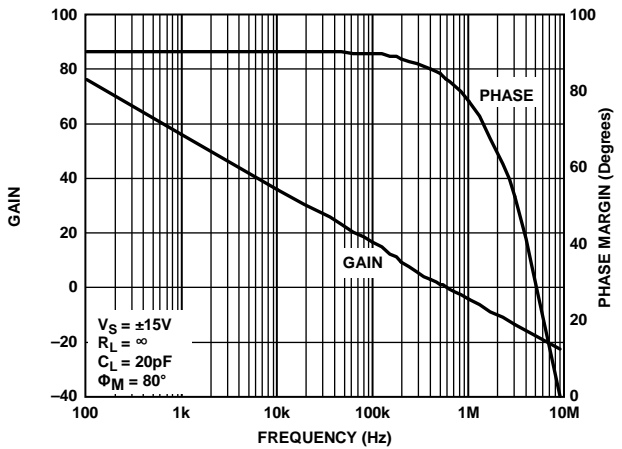

Figure 22. Open-Loop Gain and Phase vs. Frequency

05867-025

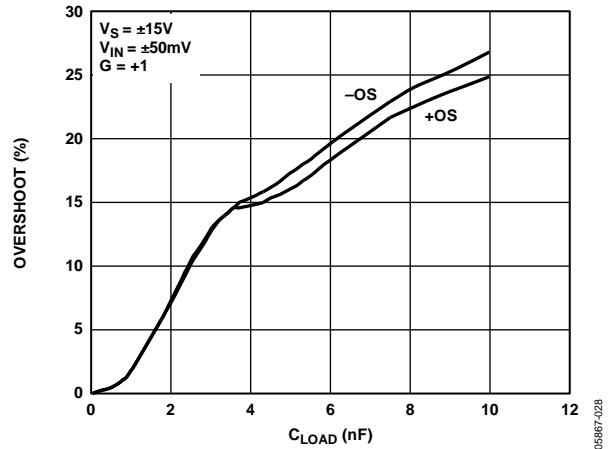

Figure 25. Overshoot vs. Capacitive Load

05867-028

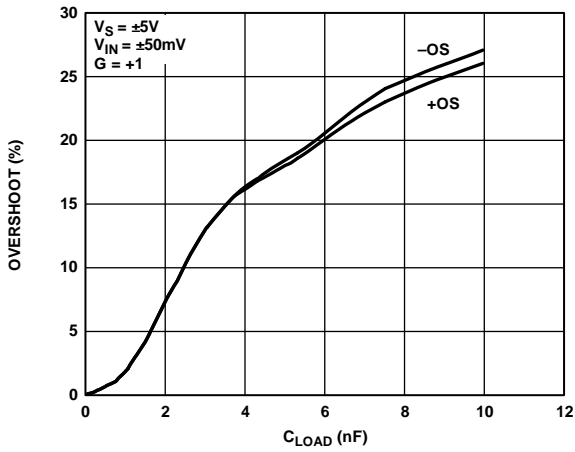

Figure 26. Overshoot vs. Capacitive Load

05867-029

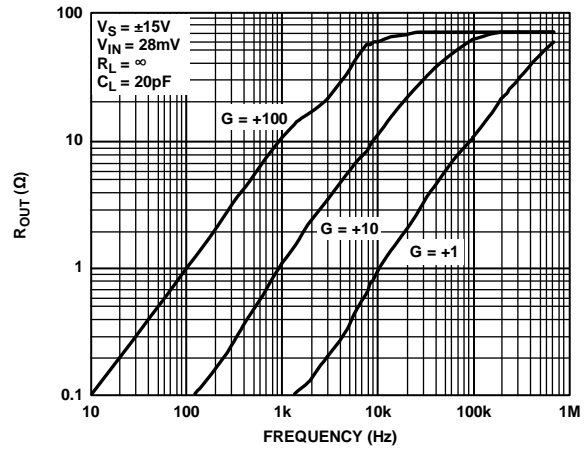

Figure 29. Output Impedance vs. Frequency

05867-032

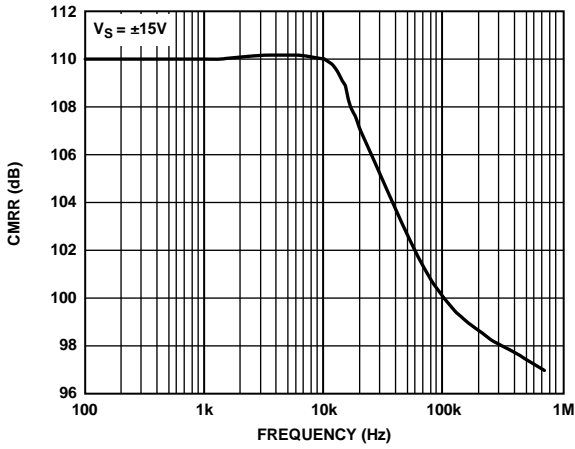

Figure 27. CMRR vs. Frequency

05867-030

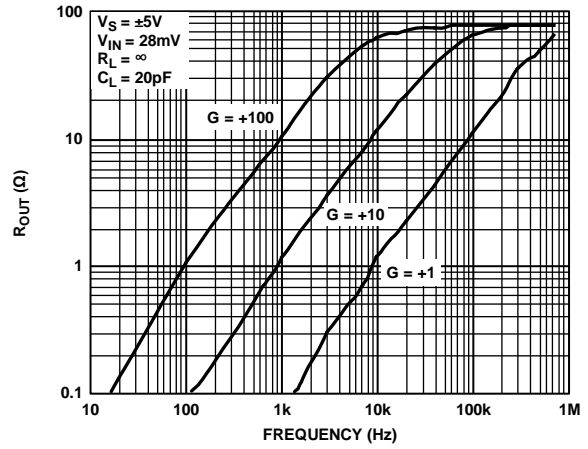

Figure 30. Output Impedance vs. Frequency

05867-033

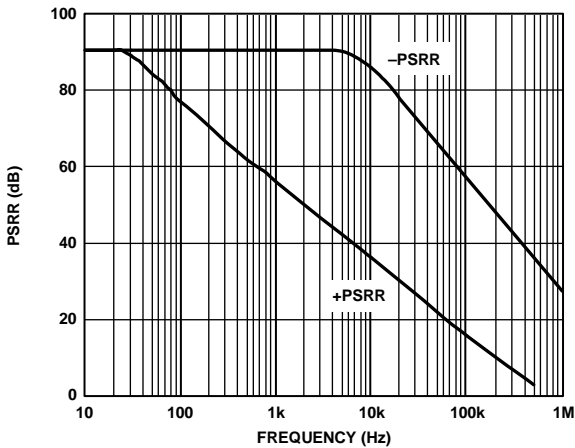

Figure 28. PSRR vs. Frequency

05867-031

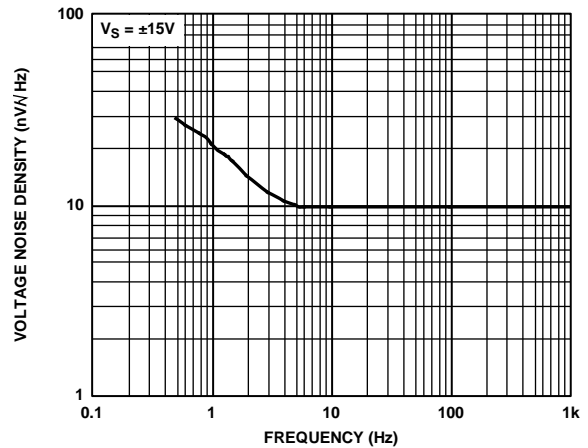

Figure 31. Voltage Noise Density vs. Frequency

05867-034

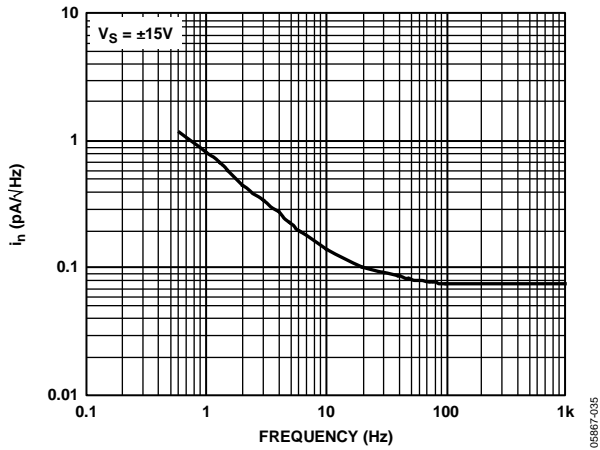

Figure 32. Current Noise Density vs. Frequency

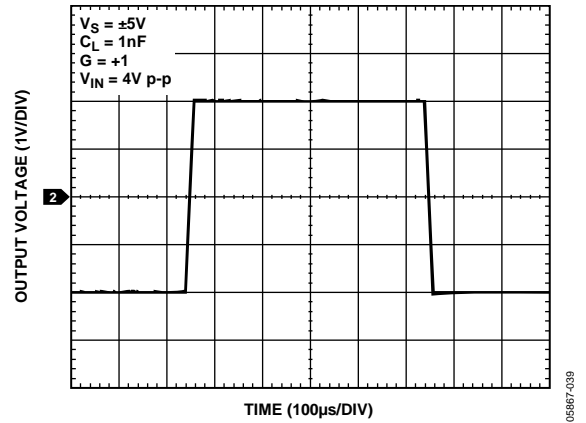

Figure 35. Large-Signal Transient

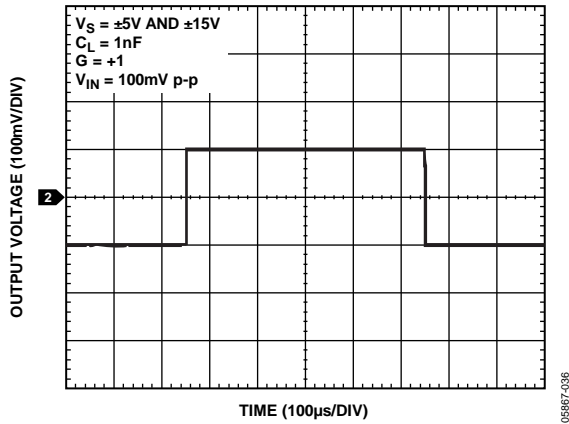

Figure 33. Small-Signal Transient

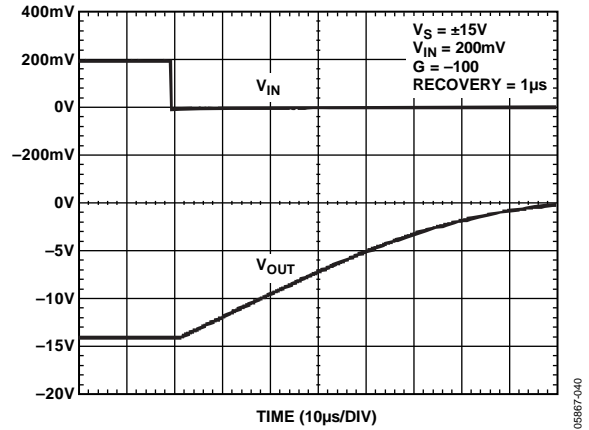

Figure 36. Positive Overload Recovery

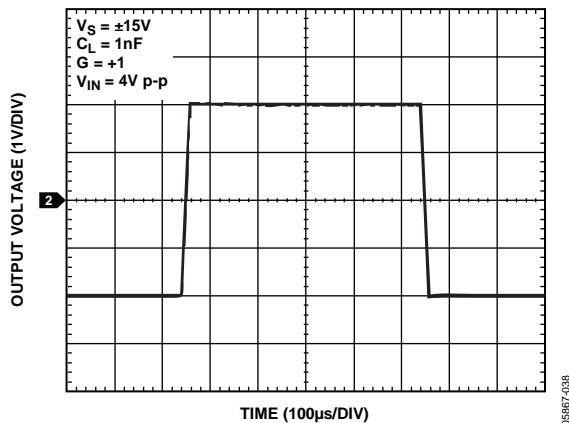

Figure 34. Large-Signal Transient

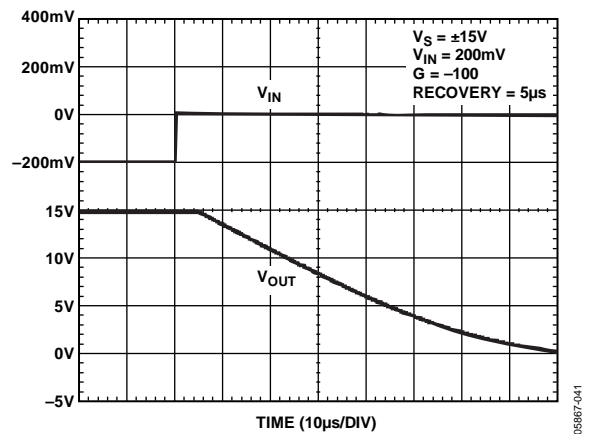

Figure 37. Negative Overload Recovery

# OP07D

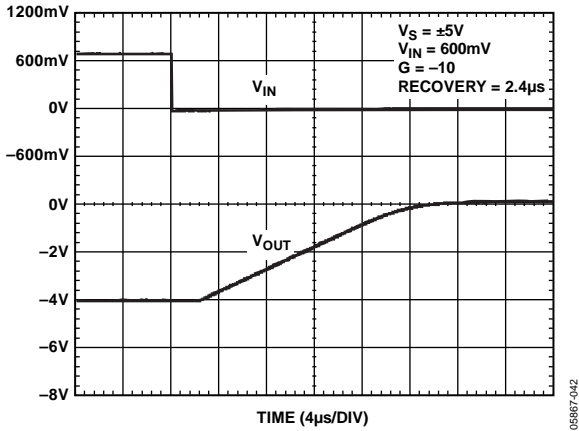

Figure 38. Positive Overload Recovery

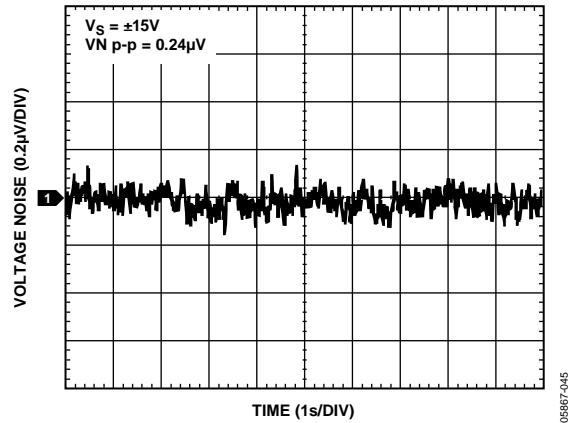

Figure 41. Voltage Noise (0.1 Hz to 10 Hz)

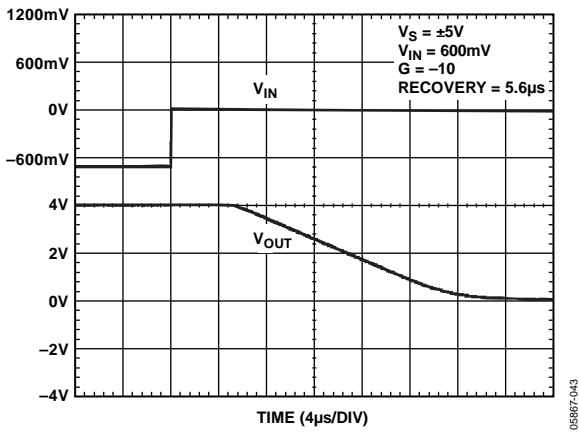

Figure 39. Negative Overload Recovery

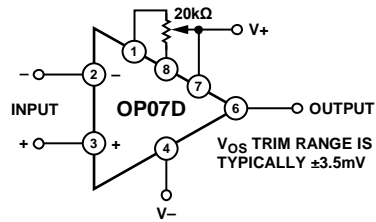

Figure 42. Optional Offset Nulling Circuit

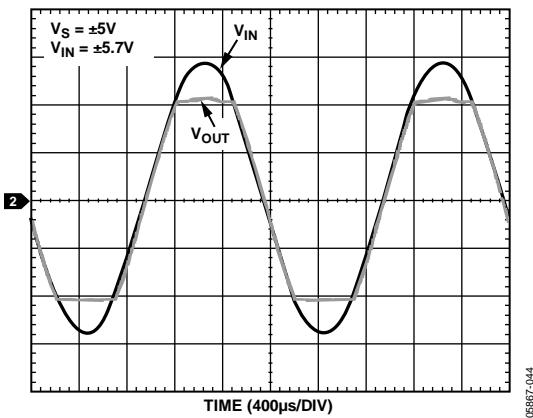
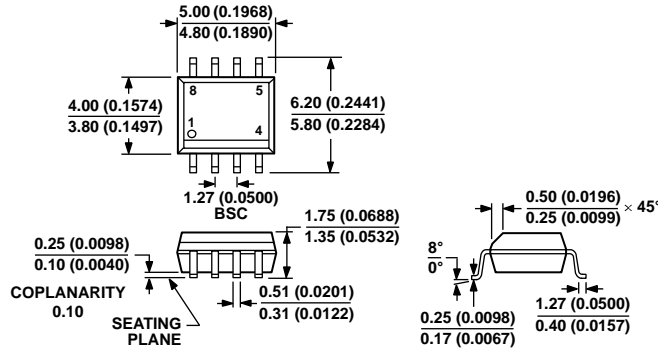

Figure 40. No Phase Reversal

# OUTLINE DIMENSIONS



COMPLIANT TO JEDEC STANDARDS MS-012-AA  
 CONTROLLING DIMENSIONS ARE IN MILLIMETERS; INCH DIMENSIONS  
 (IN PARENTHESES) ARE ROUNDED-OFF MILLIMETER EQUIVALENTS FOR  
 REFERENCE ONLY AND ARE NOT APPROPRIATE FOR USE IN DESIGN.

012407-A

Figure 43. 8-Lead Standard Small Outline Package [SOIC\_N]  
 Narrow Body  
 (R-8)

Dimensions shown in millimeters and (inches)

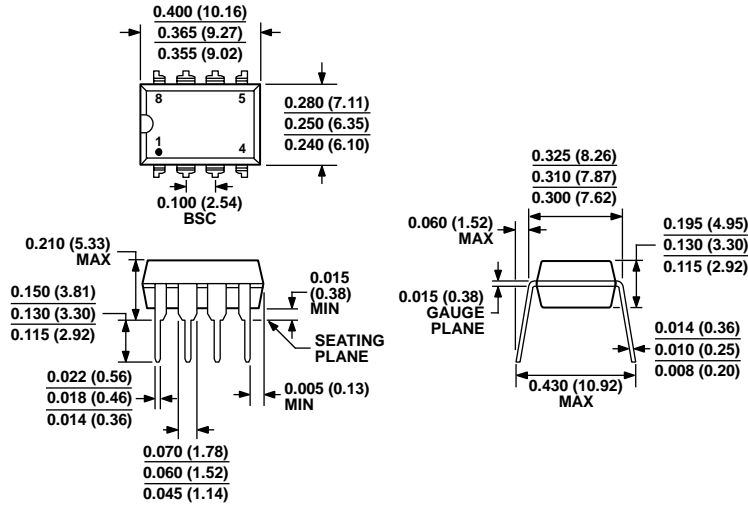

COMPLIANT TO JEDEC STANDARDS MS-001  
 CONTROLLING DIMENSIONS ARE IN INCHES; MILLIMETER DIMENSIONS  
 (IN PARENTHESES) ARE ROUNDED-OFF INCH EQUIVALENTS FOR  
 REFERENCE ONLY AND ARE NOT APPROPRIATE FOR USE IN DESIGN.  
 CORNER LEADS MAY BE CONFIGURED AS WHOLE OR HALF LEADS.

070506-A

Figure 44. 8-Lead Plastic Dual In-Line Package [PDIP]  
 (N-8)

Dimensions shown in inches and (millimeters)

# OP07D

## ORDERING GUIDE

| Model <sup>1</sup> | Temperature Range | Package Description | Package Option |
|--------------------|-------------------|---------------------|----------------|
| OP07DNZ            | -40°C to +125°C   | 8-Lead PDIP         | N-8            |
| OP07DRZ            | -40°C to +125°C   | 8-Lead SOIC_N       | R-8            |
| OP07DRZ-REEL       | -40°C to +125°C   | 8-Lead SOIC_N       | R-8            |
| OP07DRZ-REEL7      | -40°C to +125°C   | 8-Lead SOIC_N       | R-8            |

<sup>1</sup> Z = RoHS Compliant Part.

**NOTES**

**OP07D**

**NOTES**