



CEP10N6/CEB10N6

CEF10N6

N-Channel Enhancement Mode Field Effect Transistor

FEATURES

Type	V _{DS}	R _{DS(ON)}	I _D	@V _{GS}
CEP10N6	600V	0.75Ω	10A	10V
CEB10N6	600V	0.75Ω	10A	10V
CEF10N6	600V	0.75Ω	10A ^d	10V

- Super high dense cell design for extremely low R_{DS(ON)}.
- High power and current handling capability.
- Lead free product is acquired.

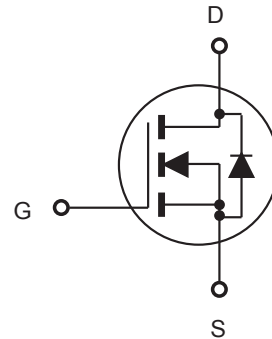
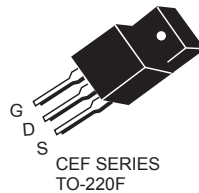
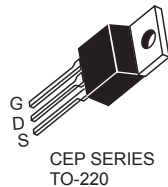

ABSOLUTE MAXIMUM RATINGS $T_C = 25^\circ\text{C}$ unless otherwise noted

Parameter	Symbol	Limit		Units
		TO-220/263	TO-220F	
Drain-Source Voltage	V _{DS}	600		V
Gate-Source Voltage	V _{GS}	±30		V
Drain Current-Continuous @ T _C = 25°C @ T _C = 100°C	I _D	10	10 ^d	A
		6	6 ^d	A
Drain Current-Pulsed ^a	I _{DM} ^e	40	40 ^d	A
Maximum Power Dissipation @ T _C = 25°C - Derate above 25°C	P _D	166	50	W
		1.3	0.4	W/°C
Single Pulsed Avalanche Energy ^h	E _{AS}	187.5		mJ
Single Pulsed Avalanche Current ^h	I _{AS}	5		A
Operating and Store Temperature Range	T _J , T _{stg}	-55 to 175		°C

Thermal Characteristics

Parameter	Symbol	Limit		Units
Thermal Resistance, Junction-to-Case	R _{θJC}	0.75	2.5	°C/W
Thermal Resistance, Junction-to-Ambient	R _{θJA}	62.5	65	°C/W



CEP10N6/CEB10N6 CEF10N6

Electrical Characteristics $T_C = 25^\circ\text{C}$ unless otherwise noted

Parameter	Symbol	Test Condition	Min	Typ	Max	Units
Off Characteristics						
Drain-Source Breakdown Voltage	BV_{DSS}	$V_{GS} = 0V, I_D = 250\mu A$	600			V
Zero Gate Voltage Drain Current	I_{DSS}	$V_{DS} = 600V, V_{GS} = 0V$			1	μA
		$V_{DS} = 480V, T_C = 125^\circ C$			10	μA
Gate Body Leakage Current, Forward	I_{GSSF}	$V_{GS} = 30V, V_{DS} = 0V$			100	nA
Gate Body Leakage Current, Reverse	I_{GSSR}	$V_{GS} = -30V, V_{DS} = 0V$			-100	nA
On Characteristics ^b						
Gate Threshold Voltage	$V_{GS(th)}$	$V_{GS} = V_{DS}, I_D = 250\mu A$	2		4	V
Static Drain-Source On-Resistance	$R_{DS(on)}$	$V_{GS} = 10V, I_D = 5A$		0.65	0.75	Ω
Dynamic Characteristics ^c						
Input Capacitance	C_{iss}	$V_{DS} = 25V, V_{GS} = 0V,$ $f = 1.0\text{ MHz}$		1760		pF
Output Capacitance	C_{oss}			220		pF
Reverse Transfer Capacitance	C_{rss}			20		pF
Switching Characteristics ^c						
Turn-On Delay Time	$t_{d(on)}$	$V_{DD} = 300V, I_D = 10A,$ $V_{GS} = 10V, R_{GEN} = 25\Omega$		32.5		ns
Turn-On Rise Time	t_r			61		ns
Turn-Off Delay Time	$t_{d(off)}$			150		ns
Turn-Off Fall Time	t_f			60		ns
Total Gate Charge	Q_g	$V_{DS} = 480V, I_D = 10A,$ $V_{GS} = 10V$		44		nC
Gate-Source Charge	Q_{gs}			7.7		nC
Gate-Drain Charge	Q_{gd}			17		nC
Drain-Source Diode Characteristics and Maximum Ratings						
Drain-Source Diode Forward Current	I_S ^f				10	A
Drain-Source Diode Forward Voltage ^b	V_{SD}	$V_{GS} = 0V, I_S = 10A$ ^g			1.4	V
Notes : □ a.Repetitive Rating : Pulse width limited by maximum junction temperature . b.Pulse Test : Pulse Width $\leq 300\mu s$, Duty Cycle $\leq 2\%$.□ c.Guaranteed by design, not subject to production testing.□ d.Limited only by maximum temperature allowed . e.Pulse width limited by safe operating area . f.Full package $I_{S(max)}$ = 6A . g.Full package V_{SD} test condition $I_S = 6A$.□ h.L = 15mH, $I_{AS} = 8.5A, V_{DD} = 50V, R_G = 25\Omega$, Starting $T_J = 25\text{ C}$						



CEP10N6/CEB10N6 CEF10N6

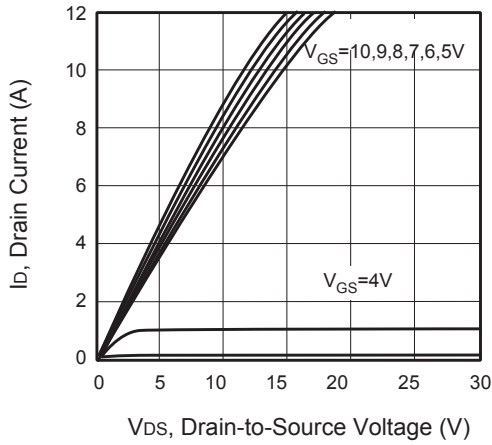

Figure 1. Output Characteristics

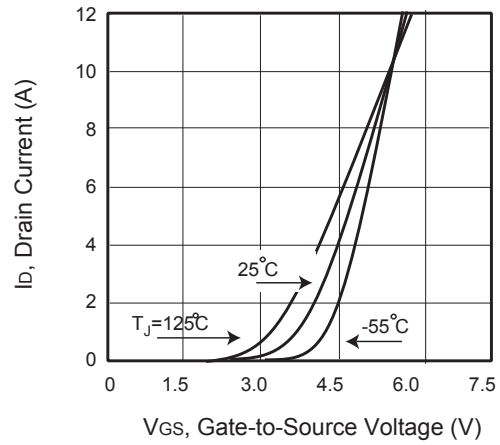

Figure 2. Transfer Characteristics

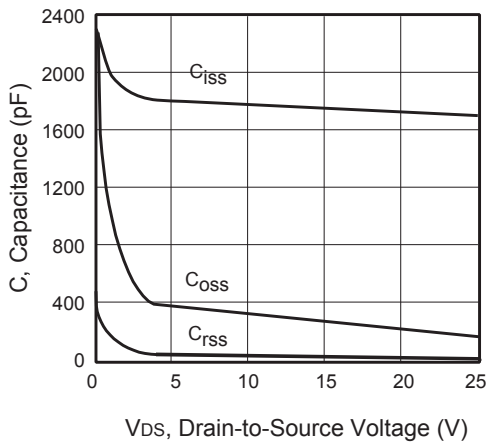

Figure 3. Capacitance

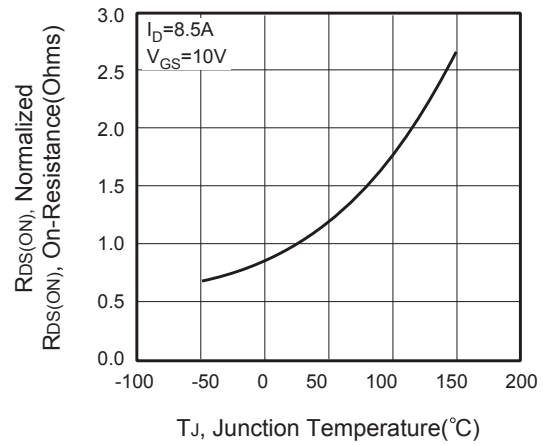

Figure 4. On-Resistance Variation with Temperature

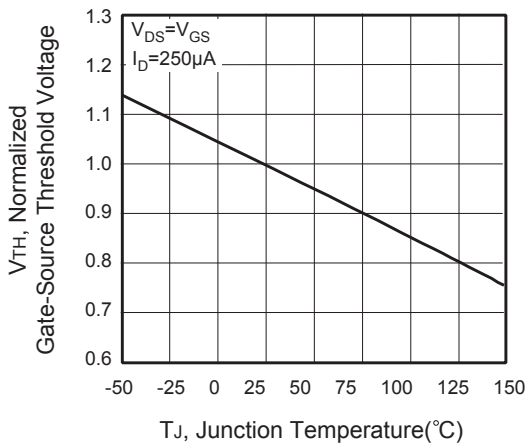

Figure 5. Gate Threshold Variation with Temperature

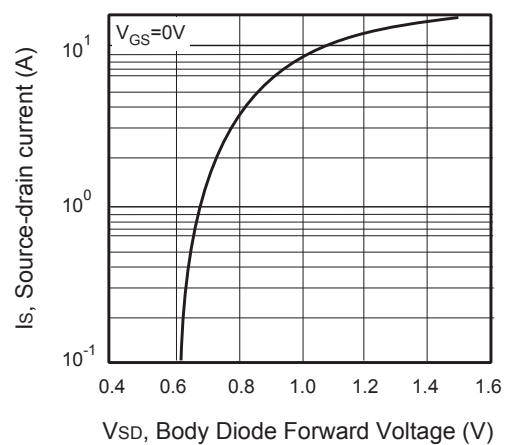

Figure 6. Body Diode Forward Voltage Variation with Source Current



CEP10N6/CEB10N6 CEF10N6

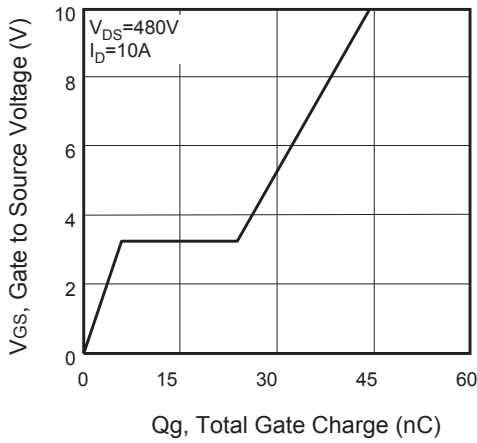

Figure 7. Gate Charge

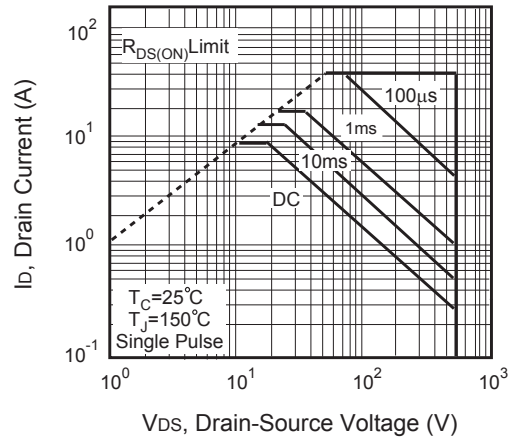

Figure 8. Maximum Safe Operating Area

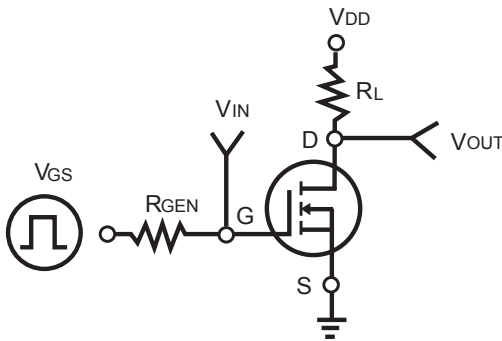

Figure 9. Switching Test Circuit

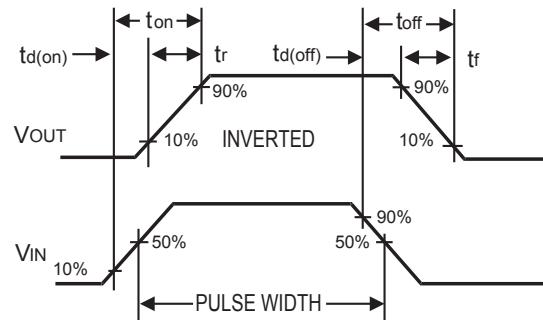

Figure 10. Switching Waveforms

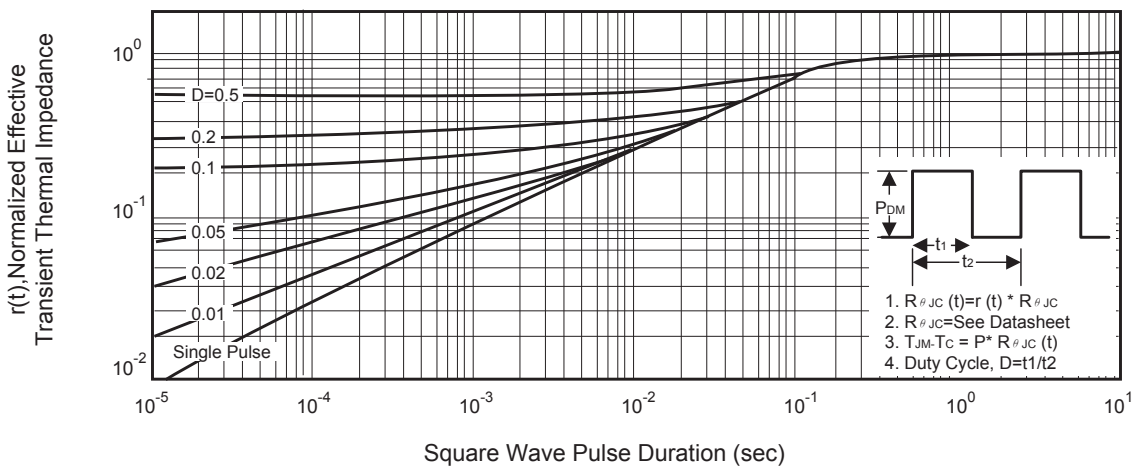

Figure 11. Normalized Thermal Transient Impedance Curve