



CEP09N6/CEB09N6 CEI09N6/CEF09N6

N-Channel Enhancement Mode Field Effect Transistor

FEATURES

Type	V _{DS}	R _{DS(ON)}	I _D	@V _{GS}
CEP09N6	600V	1.2Ω	9A	10V
CEB09N6	600V	1.2Ω	9A	10V
CEI09N6	600V	1.2Ω	9A	10V
CEF09N6	600V	1.2Ω	9A ^e	10V

- Super high dense cell design for extremely low R_{DS(ON)}.
- High power and current handling capability.
- Lead free product is acquired.
- TO-220 & TO-263 & TO-262 package & TO-220F full-pak for through hole.

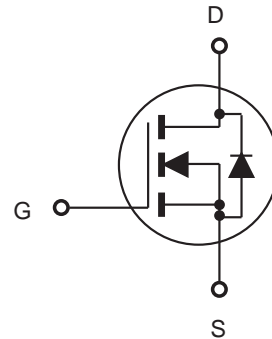
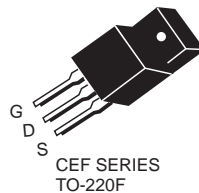
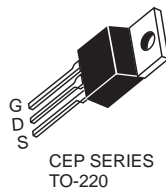
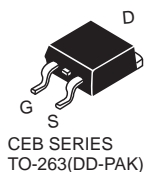

ABSOLUTE MAXIMUM RATINGS $T_C = 25^\circ\text{C}$ unless otherwise noted

Parameter	Symbol	Limit		Units
		TO-220/263/262	TO-220F	
Drain-Source Voltage	V _{DS}	600		V
Gate-Source Voltage	V _{GS}	±30		V
Drain Current-Continuous	I _D	9	9 ^e	A
Drain Current-Pulsed ^a	I _{DM} ^f	35	35 ^e	A
Maximum Power Dissipation @ T _C = 25°C - Derate above 25°C	P _D	156	50	W
		1.25	0.38	W/°C
Single Pulsed Avalanche Energy ^d	E _{AS}	500	500	mJ
Single Pulsed Avalanche Current ^d	I _{AS}	9	9	A
Operating and Store Temperature Range	T _J , T _{stg}	-55 to 150		°C

Thermal Characteristics

Parameter	Symbol	Limit		Units
Thermal Resistance, Junction-to-Case	R _{θJC}	0.8	2.6	°C/W
Thermal Resistance, Junction-to-Ambient	R _{θJA}	62.5	65	°C/W



CEP09N6/CEB09N6 CEI09N6/CEF09N6

Electrical Characteristics $T_C = 25^\circ\text{C}$ unless otherwise noted

4

Parameter	Symbol	Test Condition	Min	Typ	Max	Units
Off Characteristics						
Drain-Source Breakdown Voltage	BV_{DSS}	$V_{GS} = 0V, I_D = 250\mu A$	600			V
Zero Gate Voltage Drain Current	I_{DSS}	$V_{DS} = 600V, V_{GS} = 0V$			50	μA
Gate Body Leakage Current, Forward	I_{GSSF}	$V_{GS} = 30V, V_{DS} = 0V$			100	nA
Gate Body Leakage Current, Reverse	I_{GSSR}	$V_{GS} = -30V, V_{DS} = 0V$			-100	nA
On Characteristics^b						
Gate Threshold Voltage	$V_{GS(th)}$	$V_{GS} = V_{DS}, I_D = 250\mu A$	2		4	V
Static Drain-Source On-Resistance	$R_{DS(on)}$	$V_{GS} = 10V, I_D = 6A$		1.0	1.2	Ω
Forward Transconductance	g_{FS}	$V_{DS} = 50V, I_D = 6A$		5		S
Dynamic Characteristics^c						
Input Capacitance	C_{iss}	$V_{DS} = 25V, V_{GS} = 0V,$ $f = 1.0\text{ MHz}$		950		pF
Output Capacitance	C_{oss}			135		pF
Reverse Transfer Capacitance	C_{rss}			90		pF
Switching Characteristics^c						
Turn-On Delay Time	$t_{d(on)}$	$V_{DD} = 200V, I_D = 9A,$ $V_{GS} = 10V, R_{GEN} = 9.1\Omega$		23	45	ns
Turn-On Rise Time	t_r			26	50	ns
Turn-Off Delay Time	$t_{d(off)}$			105	165	ns
Turn-Off Fall Time	t_f			22	45	ns
Total Gate Charge	Q_g	$V_{DS} = 480V, I_D = 2A,$ $V_{GS} = 10V$		73	85	nC
Gate-Source Charge	Q_{gs}			6		nC
Gate-Drain Charge	Q_{gd}			45		nC
Drain-Source Diode Characteristics and Maximum Ratings						
Drain-Source Diode Forward Current	I_S^g				9	A
Drain-Source Diode Forward Voltage ^b	V_{SD}	$V_{GS} = 0V, I_S = 9A$			1.5	V
Notes : a.Repetitive Rating : Pulse width limited by maximum junction temperature . b.Pulse Test : Pulse Width $\leq 300\mu s$, Duty Cycle $\leq 2\%$. c.Guaranteed by design, not subject to production testing. d.L = 23.4mH, $I_{AS} = 9A$, $V_{DD} = 60V$, $R_G = 25\Omega$, Starting $T_J = 25^\circ\text{C}$. e.Limited only by maximum temperature allowed . f.Pulse width limited by safe operating area . g.Full package $I_{S(max)} = 5A$.						



CEP09N6/CEB09N6 CEI09N6/CEF09N6

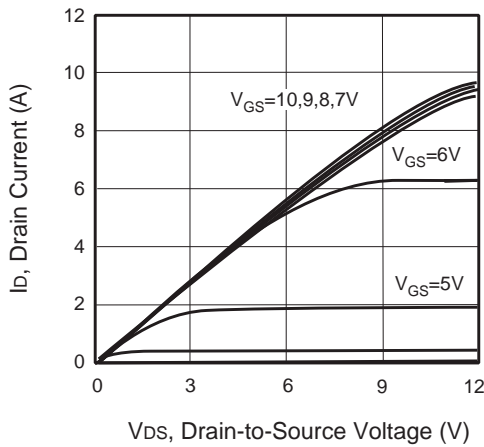

Figure 1. Output Characteristics

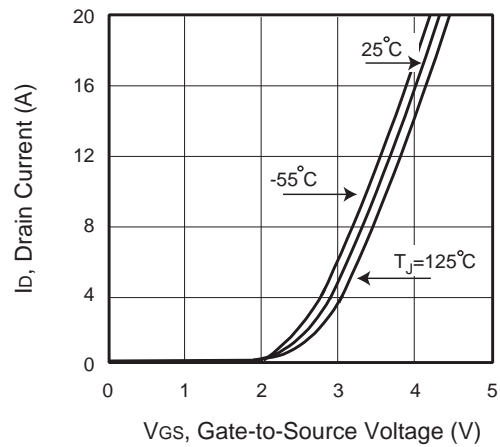

Figure 2. Transfer Characteristics

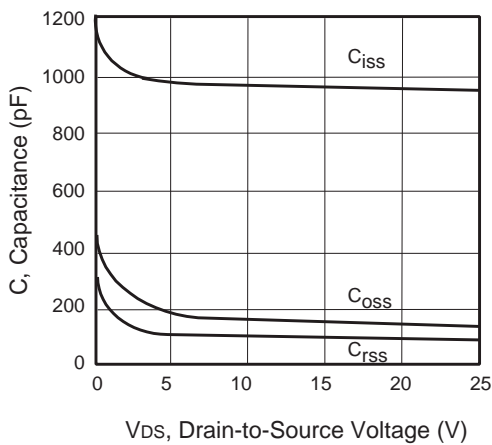

Figure 3. Capacitance

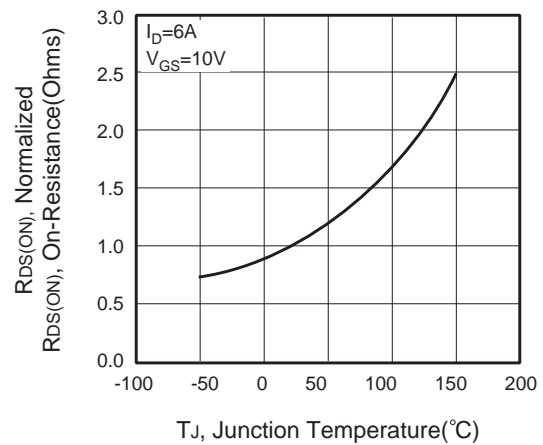

Figure 4. On-Resistance Variation with Temperature

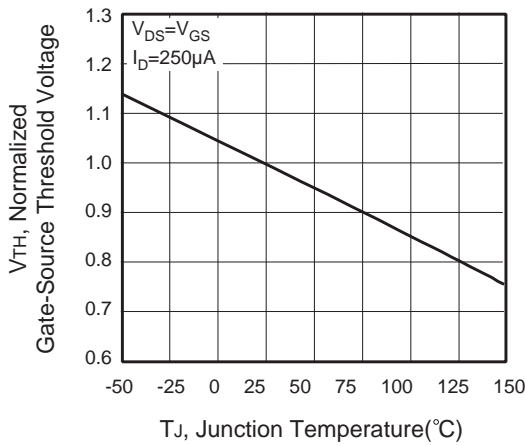

Figure 5. Gate Threshold Variation with Temperature

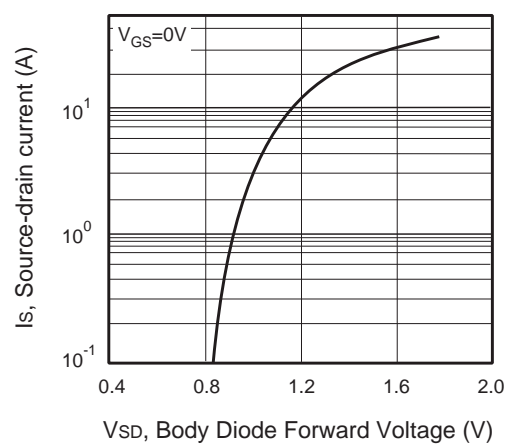

Figure 6. Body Diode Forward Voltage Variation with Source Current



CEP09N6/CEB09N6 CEI09N6/CEF09N6

4

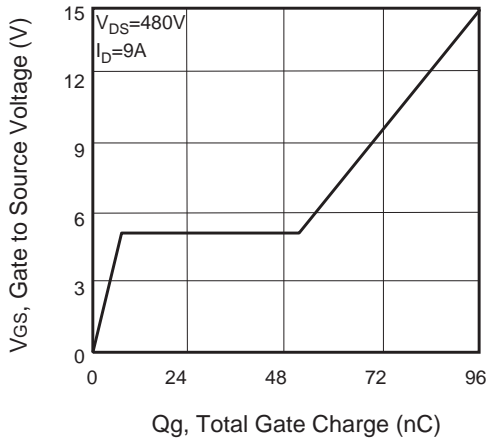

Figure 7. Gate Charge

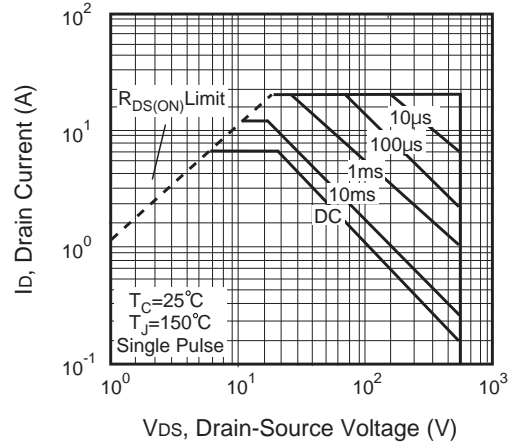

Figure 8. Maximum Safe Operating Area

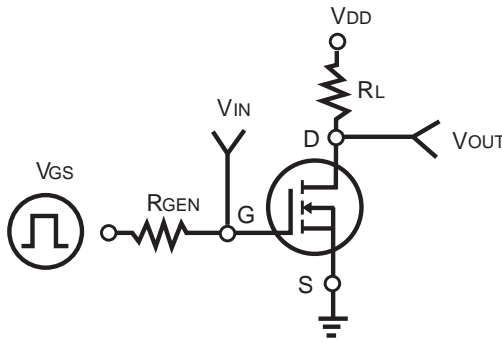

Figure 9. Switching Test Circuit

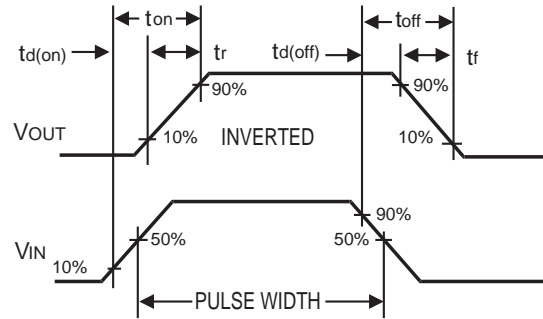

Figure 10. Switching Waveforms

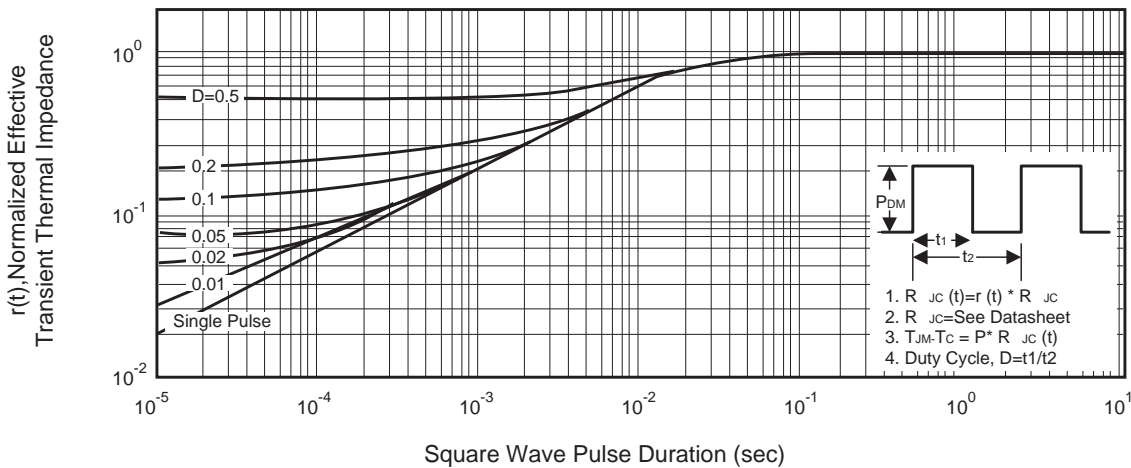

Figure 11. Normalized Thermal Transient Impedance Curve