



# CED6030L/CEU6030L

## N-Channel Enhancement Mode Field Effect Transistor

### FEATURES

- 30V, 40A,  $R_{DS(ON)} = 15.5m\Omega$  @  $V_{GS} = 10V$ .  
 $R_{DS(ON)} = 22m\Omega$  @  $V_{GS} = 4.5V$ .
- Super high dense cell design for extremely low  $R_{DS(ON)}$ .
- High power and current handling capability.
- Lead free product is acquired.
- TO-251 & TO-252 package.

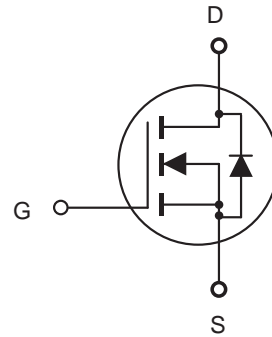

### ABSOLUTE MAXIMUM RATINGS $T_C = 25^\circ C$ unless otherwise noted

| Parameter   | Symbol         | Limit      | Units         |
|---|----------------|------------|---------------|
| Drain-Source Voltage  | $V_{DS}$       | 30         | V             |
| Gate-Source Voltage   | $V_{GS}$       | $\pm 20$   | V             |
| Drain Current-Continuous  | $I_D$          | 40         | A             |
| Drain Current-Pulsed <sup>a</sup>   | $I_{DM}$       | 120        | A             |
| Maximum Power Dissipation @ $T_C = 25^\circ C$<br>- Derate above $25^\circ C$ | $P_D$          | 50         | W             |
|   |                | 0.3        | W/ $^\circ C$ |
| Operating and Store Temperature Range   | $T_J, T_{stg}$ | -55 to 175 | $^\circ C$    |

### Thermal Characteristics

| Parameter                               | Symbol          | Limit | Units        |
|---|-----------------|-------|--------------|
| Thermal Resistance, Junction-to-Case    | $R_{\theta JC}$ | 3     | $^\circ C/W$ |
| Thermal Resistance, Junction-to-Ambient | $R_{\theta JA}$ | 50    | $^\circ C/W$ |



# CED6030L/CEU6030L

## Electrical Characteristics $T_C = 25^\circ\text{C}$ unless otherwise noted

| Parameter  | Symbol       | Test Condition  | Min | Typ  | Max  | Units     |
|--|--------------|---|-----|------|------|-----------|
| <b>Off Characteristics</b>   |              |   |     |      |      |           |
| Drain-Source Breakdown Voltage   | $BV_{DSS}$   | $V_{GS} = 0V, I_D = 250\mu A$                               | 30  |      |      | V         |
| Zero Gate Voltage Drain Current  | $I_{DSS}$    | $V_{DS} = 24V, V_{GS} = 0V$                                 |     |      | 1    | $\mu A$   |
| Gate Body Leakage Current, Forward   | $I_{GSSF}$   | $V_{GS} = 20V, V_{DS} = 0V$                                 |     |      | 100  | nA        |
| Gate Body Leakage Current, Reverse   | $I_{GSSR}$   | $V_{GS} = -20V, V_{DS} = 0V$                                |     |      | -100 | nA        |
| <b>On Characteristics <sup>b</sup></b>   |              |   |     |      |      |           |
| Gate Threshold Voltage   | $V_{GS(th)}$ | $V_{GS} = V_{DS}, I_D = 250\mu A$                           | 1   | 1.6  | 3    | V         |
| Static Drain-Source On-Resistance  | $R_{DS(on)}$ | $V_{GS} = 10V, I_D = 20A$                                   |     | 12   | 15.5 | $m\Omega$ |
|  |              | $V_{GS} = 4.5V, I_D = 18A$                                  |     | 18.5 | 22   | $m\Omega$ |
| Forward Transconductance   | $g_{FS}$     | $V_{DS} = 10V, I_D = 26A$                                   |     | 32   |      | S         |
| <b>Dynamic Characteristics <sup>c</sup></b>  |              |   |     |      |      |           |
| Input Capacitance  | $C_{iss}$    | $V_{DS} = 15V, V_{GS} = 0V, f = 1.0\text{ MHz}$             |     | 1315 |      | pF        |
| Output Capacitance   | $C_{oss}$    |   |     | 525  |      | pF        |
| Reverse Transfer Capacitance   | $C_{rss}$    |   |     | 110  |      | pF        |
| <b>Switching Characteristics <sup>c</sup></b>  |              |   |     |      |      |           |
| Turn-On Delay Time   | $t_{d(on)}$  | $V_{DD} = 15V, I_D = 40A, V_{GS} = 10V, R_{GEN} = 24\Omega$ |     | 10   | 16   | ns        |
| Turn-On Rise Time  | $t_r$        |   |     | 190  | 250  | ns        |
| Turn-Off Delay Time  | $t_{d(off)}$ |   |     | 55   | 90   | ns        |
| Turn-Off Fall Time   | $t_f$        |   |     | 130  | 200  | ns        |
| Total Gate Charge  | $Q_g$        | $V_{DS} = 24V, I_D = 40A, V_{GS} = 5V$                      |     | 19   | 23   | nC        |
| Gate-Source Charge   | $Q_{gs}$     |   |     | 5    |      | nC        |
| Gate-Drain Charge  | $Q_{gd}$     |   |     | 9    |      | nC        |
| <b>Drain-Source Diode Characteristics and Maximum Ratings</b>  |              |   |     |      |      |           |
| Drain-Source Diode Forward Current   | $I_S$        |   |     |      | 40   | A         |
| Drain-Source Diode Forward Voltage <sup>bbbb</sup>   | $V_{SD}$     | $V_{GS} = 0V, I_S = 26A$                                    |     | 0.9  | 1.3  | V         |
| <b>Notes :</b><br>a.Repetitive Rating : Pulse width limited by maximum junction temperature.<br>b.Pulse Test : Pulse Width $\leq 300\mu s$ , Duty Cycle $\leq 2\%$ .<br>c.Guaranteed by design, not subject to production testing. |              |   |     |      |      |           |

6



# CED6030L/CEU6030L

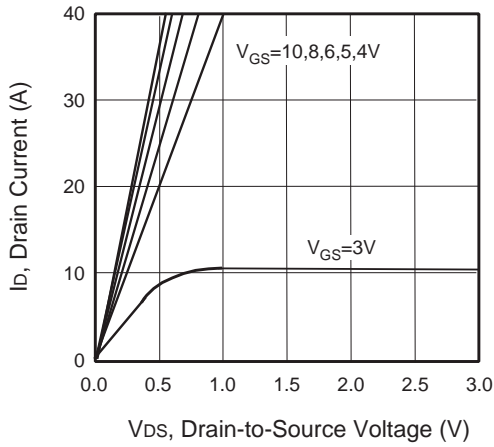

Figure 1. Output Characteristics

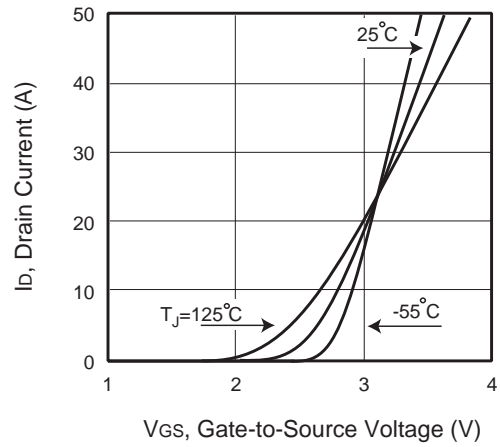

Figure 2. Transfer Characteristics

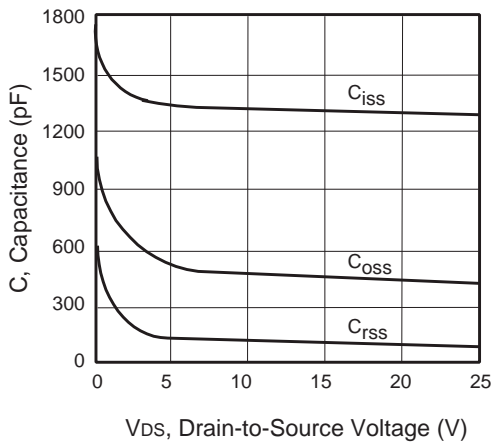

Figure 3. Capacitance

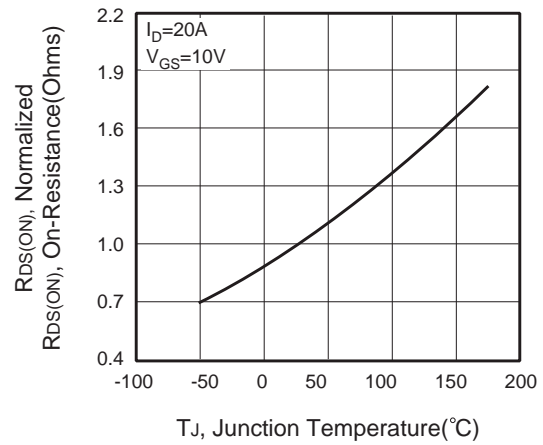

Figure 4. On-Resistance Variation with Temperature

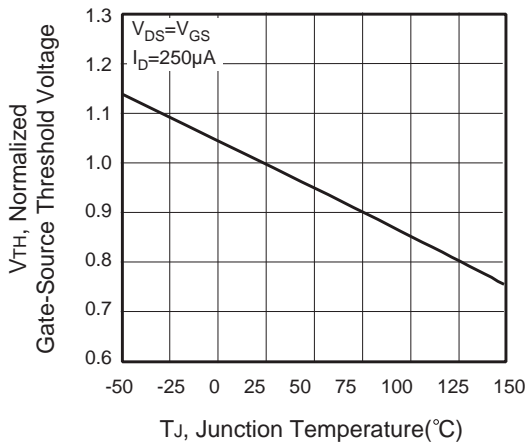

Figure 5. Gate Threshold Variation with Temperature

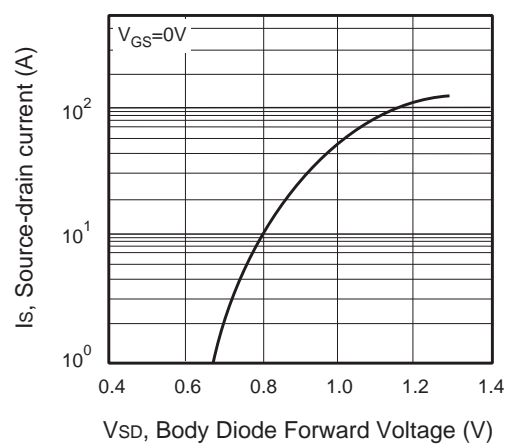

Figure 6. Body Diode Forward Voltage Variation with Source Current



# CED6030L/CEU6030L

6

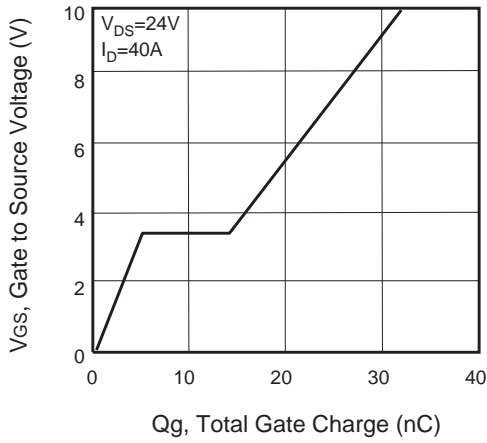

Figure 7. Gate Charge

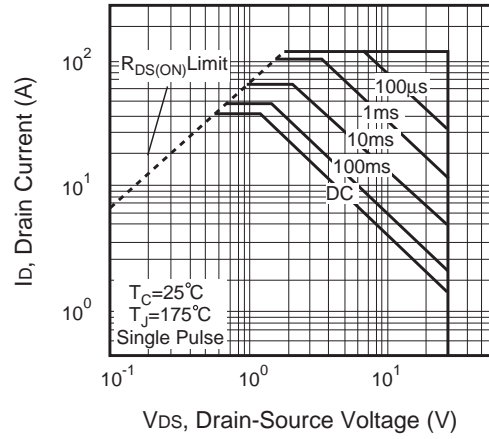

Figure 8. Maximum Safe Operating Area

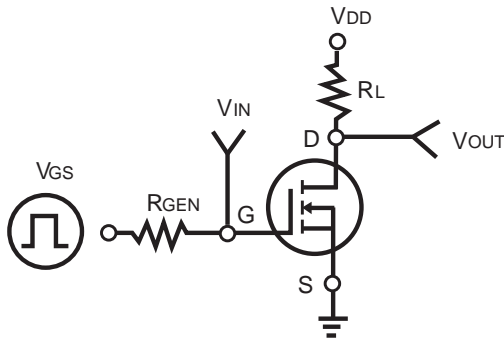

Figure 9. Switching Test Circuit

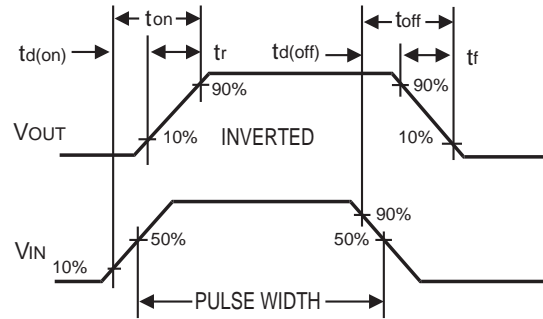

Figure 10. Switching Waveforms

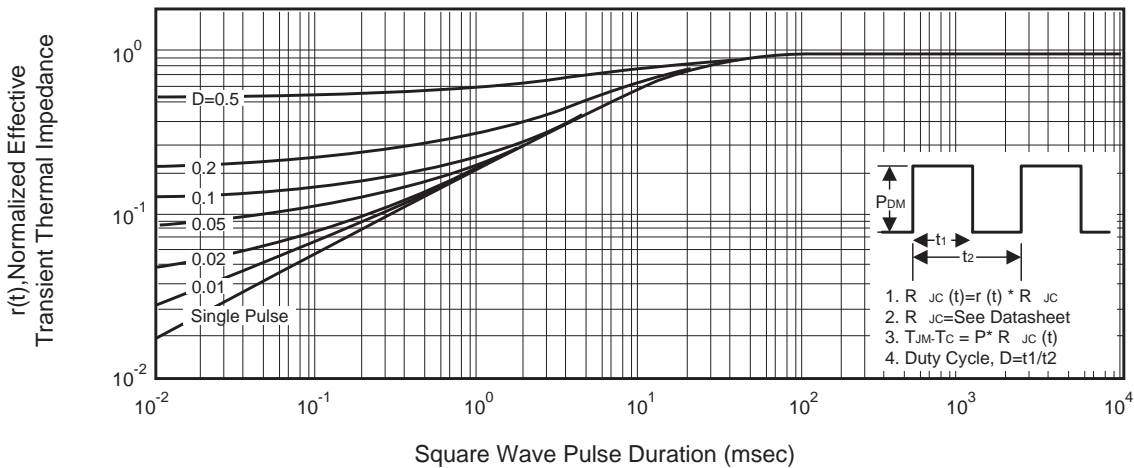

Figure 11. Normalized Thermal Transient Impedance Curve