

FEATURES

1. This specification shall be applied to photocoupler. Model No. LTV-817 as an option.

2. Applicable Models (Business dealing name)

* Dual-in-line package :

LTV817-V : 1-channel type / LTV827-V : 2-channel type /

LTV847-V : 4-channel type

* Wide lead spacing package :

LTV817M-V : 1-channel type / LTV827M-V : 2-channel type /

LTV847M-V : 4-channel type

* Surface mounting package :

LTV817S-V : 1-channel type / LTV827S-V : 2-channel type /

LTV847S-V : 4-channel type

* Tape and reel packaging :

LTV817STA1-V, LTV827STA1-V

3. The relevant models are the models Approved by VDE

according to DIN VDE 0884:1992-06

Approved Model No.: LTV-817 / LTV-827 / LTV-847 / LTV-817M / LTV-827M /

LTV-847M / LTV-817S / LTV-827S / LTV-847S

VDE approved No.: 094722

(According to the specification DIN VDE 0884:1992-06)

* Operating isolation voltage V_{IORM} : 850V (Peak)

* Transient voltage V_{TR} : 6000V (Peak)

* Pollution : 2 (According to VDE 0110-1 : 1997-04)

* Clearances distance (Between input and output) : 7.0mm (MIN.)

* Creepage distance (Between input and output) : 7.0mm (MIN.)

* Isolation thickness between input and output : 0.4mm (MIN.)

* Safety limit values Current (Isi) : 400mA (Diode side)

Power (Psi) : 700mW (Phototransistor side)

Temperature(Tsi) : 175°C

In order to keep safety electric isolation of photocoupler, please set the protective circuit to keep within safety limit values when the actual application equipment troubled.

* Indication of VDE 0884 approval prints "4" for 4-pin and "" for 8 & 16 pin on sleeve package.

OUTLINE DIMENSIONS

LTV817-V :

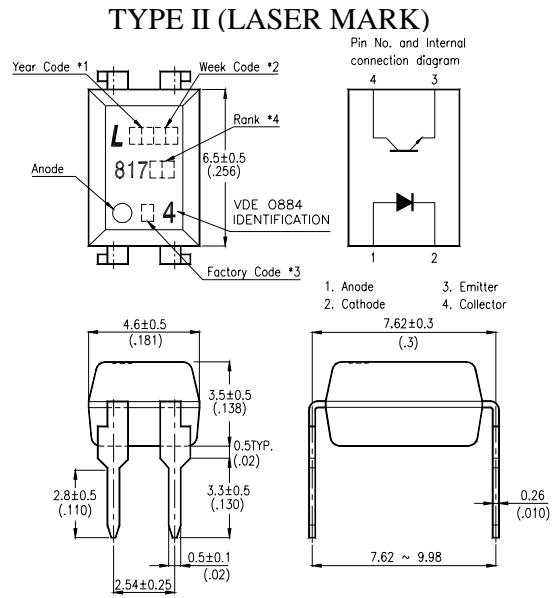
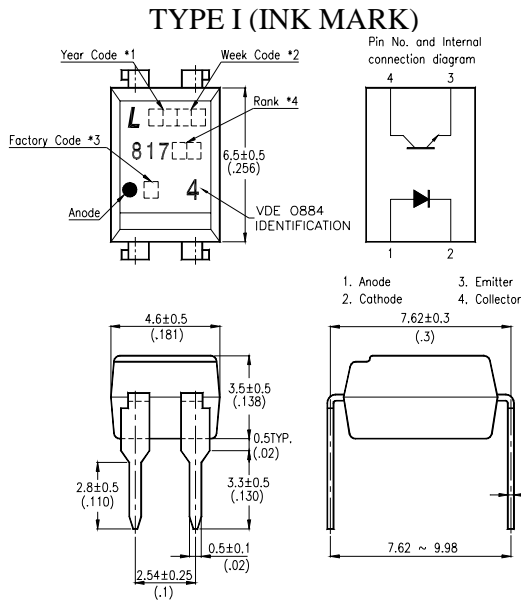

LTV827-V :

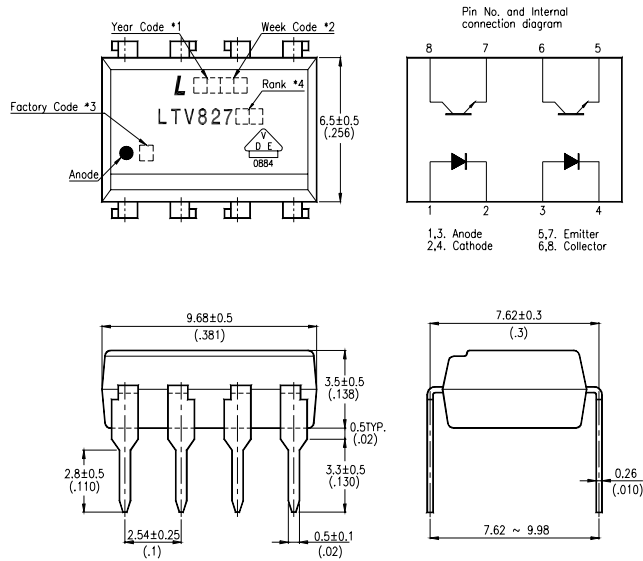

- *1. Year date code.
- *2. 2-digit work week.
- *3. Factory identification mark shall be marked (Z : Taiwan, Y : Thailand, X : China).
- *4. Rank shall be or shall not be marked.

OUTLINE DIMENSIONS

LTV847-V :

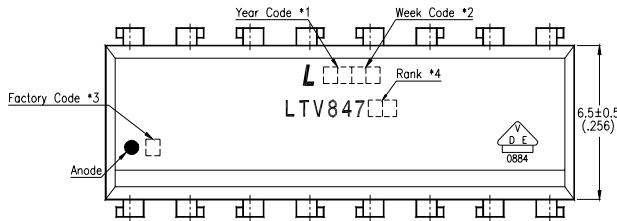

PIN NO. AND INTERNAL CONNECTION DIAGRAM

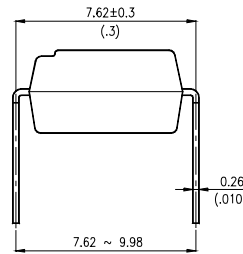
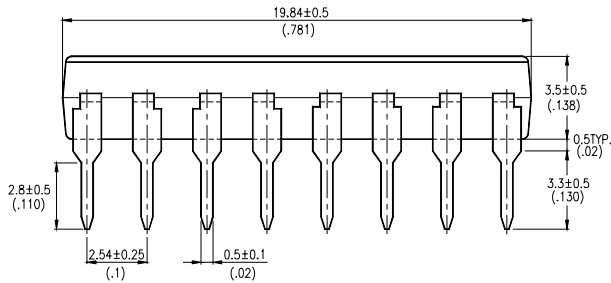
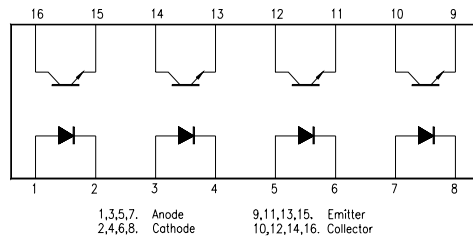

LTV817M-V :

TYPE I (INK MARK)

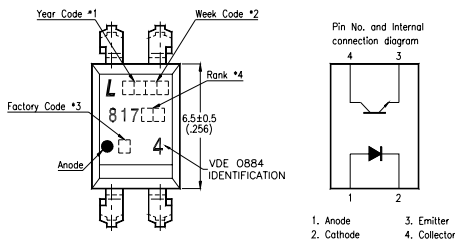

TYPE II (LASER MARK)

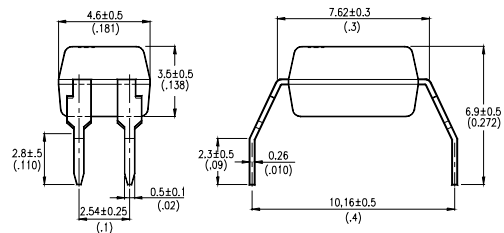
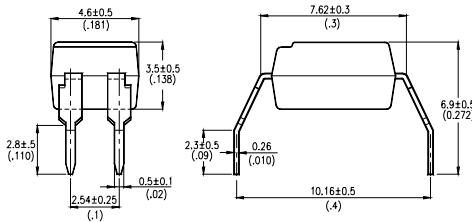
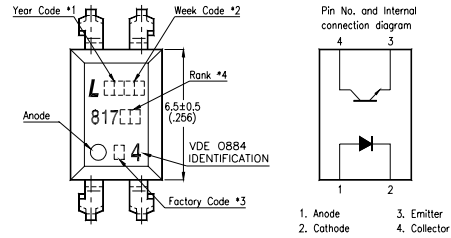

- *1. Year date code.
- *2. 2-digit work week.
- *3. Factory identification mark shall be marked (Z : Taiwan, Y : Thailand, X : China).
- *4. Rank shall be or shall not be marked.

OUTLINE DIMENSIONS

LTV827M-V :

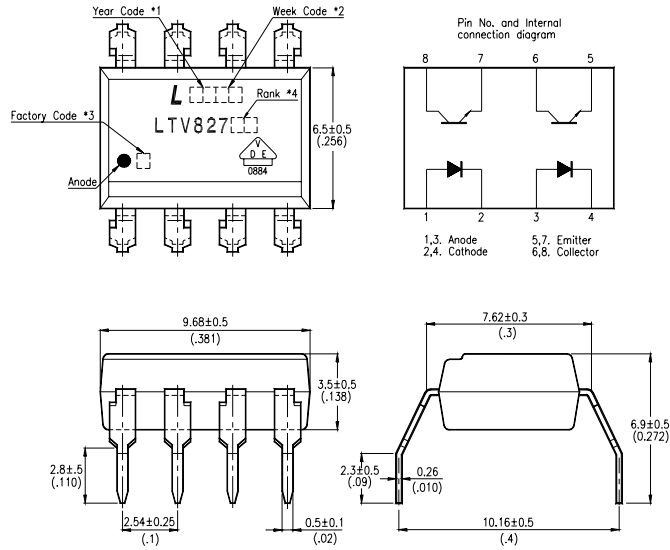

LTV847M-V :

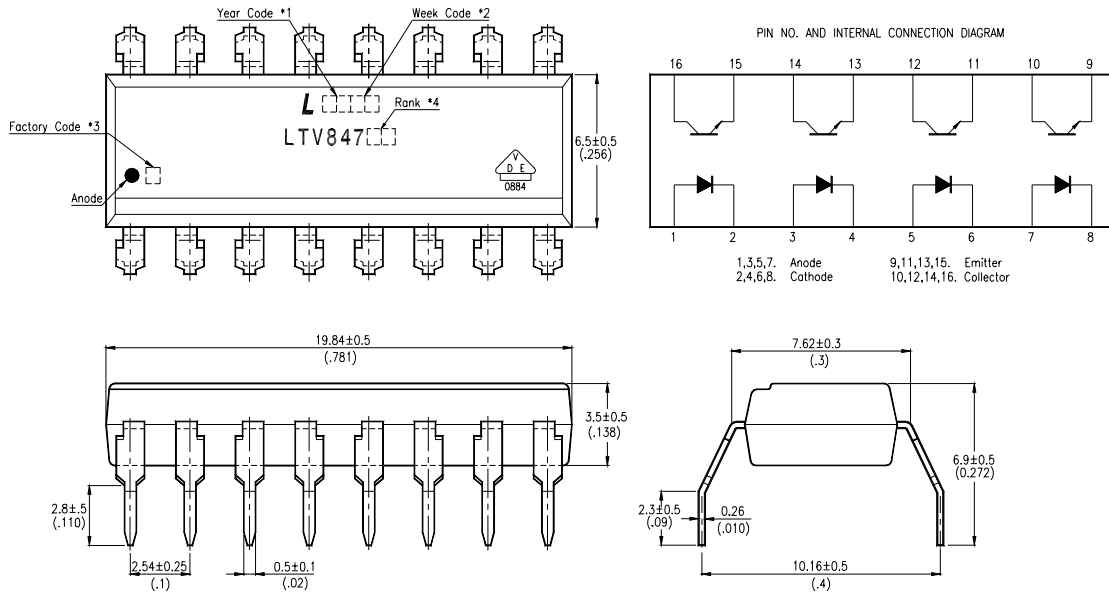

- *1. Year date code.
- *2. 2-digit work week.
- *3. Factory identification mark shall be marked (Z : Taiwan, Y : Thailand, X : China).
- *4. Rank shall be or shall not be marked.

OUTLINE DIMENSIONS

LTV817S-V :

TYPE I (INK MARK)

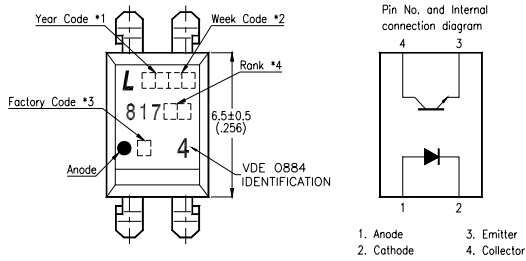

TYPE II (LASER MARK)

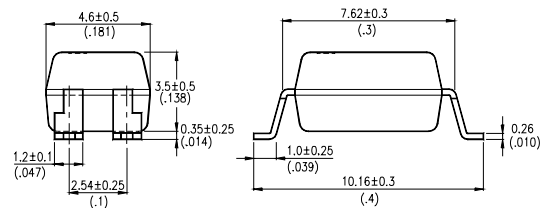
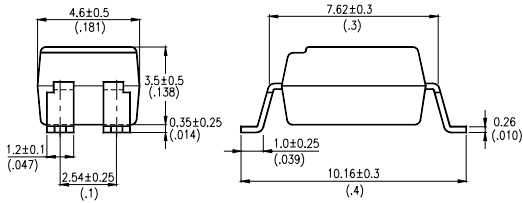
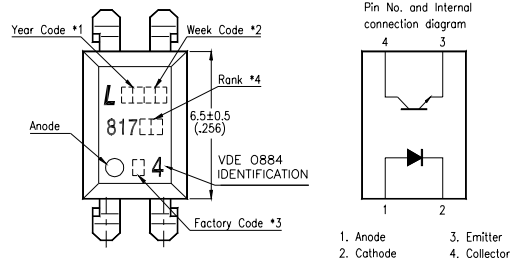

LTV827S-V :

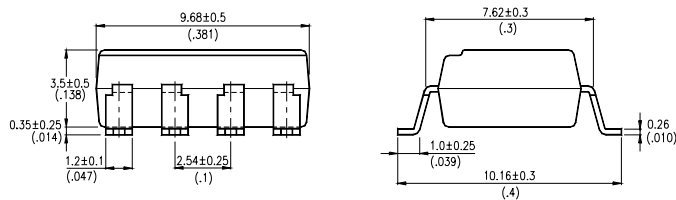
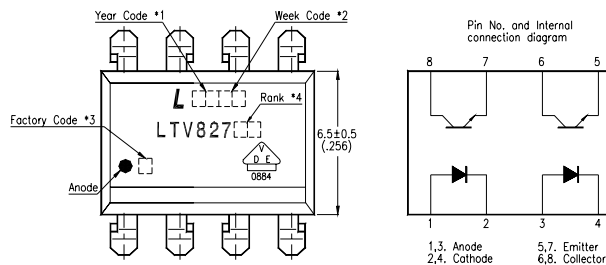

- *1. Year date code.
- *2. 2-digit work week.
- *3. Factory identification mark shall be marked (Z : Taiwan, Y : Thailand, X : China).
- *4. Rank shall be or shall not be marked.

OUTLINE DIMENSIONS

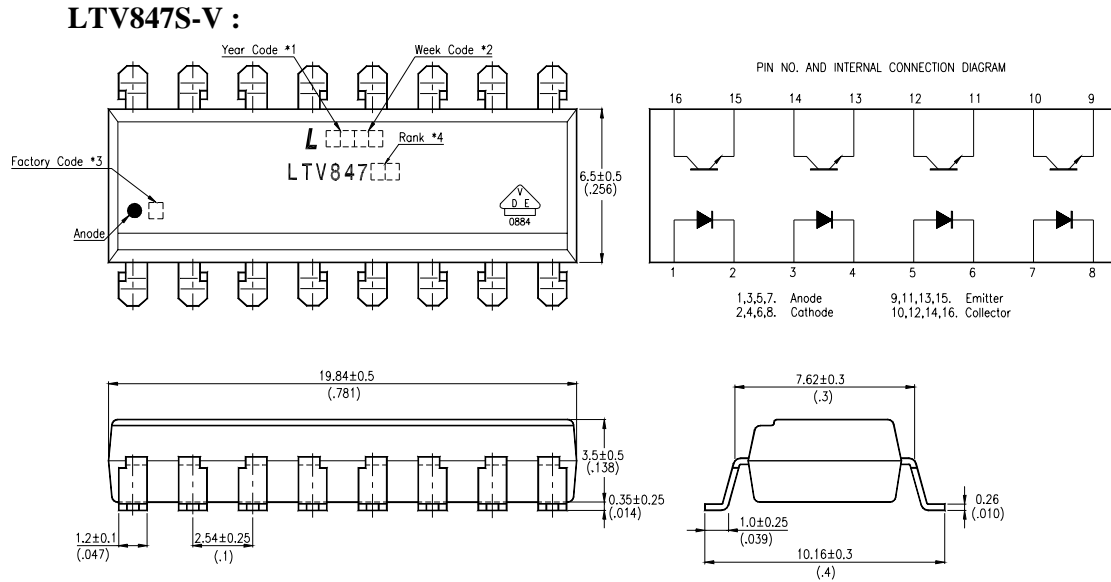

- *1. Year date code.
- *2. 2-digit work week.
- *3. Factory identification mark shall be marked (Z : Taiwan, Y : Thailand, X : China).
- *4. Rank shall be or shall not be marked.

TAPING DIMENSIONS

LTV817STA1-V :

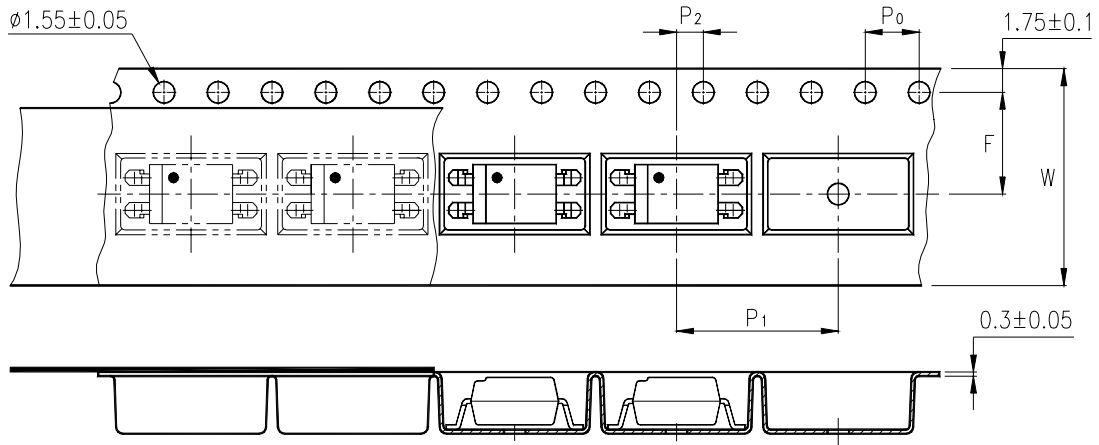

LTV827STA1-V :

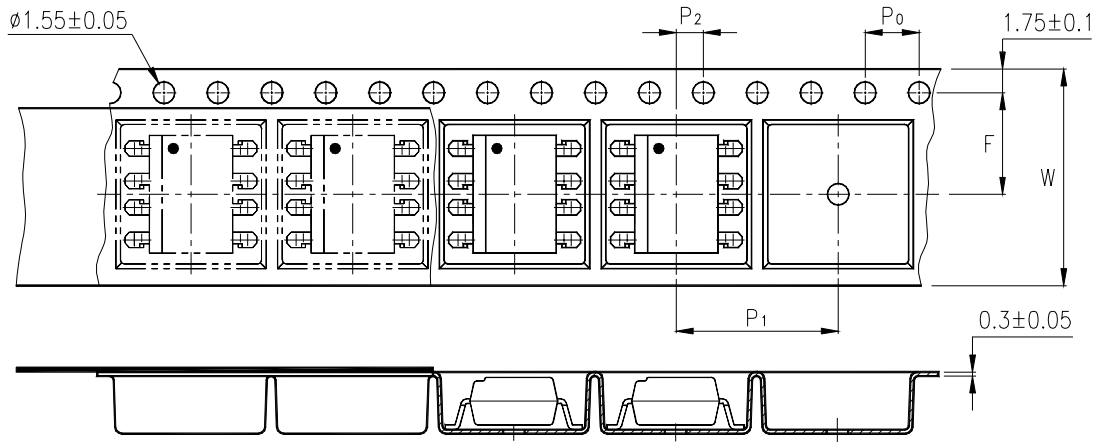

Description	Symbol	Dimensions in mm (inches)
Tape wide	W	16 ± 0.3 (.63)
Pitch of sprocket holes	P_0	4 ± 0.1 (.15)
Distance of compartment	F	7.5 ± 0.1 (.295)
	P_2	2 ± 0.1 (.079)
Distance of compartment to compartment	P_1	12 ± 0.1 (.472)

ABSOLUTE MAXIMUM RATING

(Ta = 25°C)

PARAMETER		SYMBOL	RATING	UNIT
INPUT	Forward Current	I_F	50	mA
	Reverse Voltage	V_R	6	V
	Power Dissipation	P	70	mW
OUTPUT	Collector - Emitter Voltage	V_{CEO}	35	V
	Emitter - Collector Voltage	V_{ECO}	6	V
	Collector Current	I_C	50	mA
	Collector Power Dissipation	P_C	150	mW
Total Power Dissipation		P_{tot}	200	mW
*1	Isolation Voltage	V_{iso}	5,000	V _{rms}
Operating Temperature		T_{opr}	-30 ~ +100	°C
Storage Temperature		T_{stg}	-55 ~ +125	°C
*2	Soldering Temperature	T_{sol}	260	°C

*1. AC For 1 Minute, R.H. = 40 ~ 60%

Isolation voltage shall be measured using the following method.

- (1) Short between anode and cathode on the primary side and between collector and emitter on the secondary side.
- (2) The isolation voltage tester with zero-cross circuit shall be used.
- (3) The waveform of applied voltage shall be a sine wave.

*2. For 10 Seconds

ELECTRICAL - OPTICAL CHARACTERISTICS

(Ta = 25°C)

PARAMETER		SYMBOL	MIN.	TYP.	MAX.	UNIT	CONDITIONS
INPUT	Forward Voltage	V _F	—	1.2	1.4	V	I _F =20mA
	Reverse Current	I _R	—	—	10	μA	V _R =4V
	Terminal Capacitance	C _t	—	30	250	pF	V=0, f=1KHz
OUTPUT	Collector Dark Current	I _{CEO}	—	—	100	nA	V _{CE} =20V, I _F =0
	Collector-Emitter Breakdown Voltage	BV _{CEO}	35	—	—	V	I _C =0.1mA I _F =0
	Emitter-Collector Breakdown Voltage	BV _{ECO}	6	—	—	V	I _E =10μA I _F =0
TRANSFER CHARACTERISTICS	Collector Current	I _C	2.5	—	30	mA	I _F =5mA V _{CE} =5V
	* Current Transfer Ratio	CTR	50	—	600	%	
	Collector-Emitter Saturation Voltage	V _{CE(sat)}	—	0.1	0.2	V	I _F =20mA I _C =1mA
	Isolation Resistance	R _{iso}	5×10 ¹⁰	1×10 ¹¹	—	Ω	DC500V 40 ~ 60% R.H.
	Floating Capacitance	C _f	—	0.6	1	pF	V=0, f=1MHz
	Cut-Off Frequency	f _c	—	80	—	kHz	V _{CE} =5V, I _C =2mA R _L =100Ω, -3dB
	Response Time (Rise)	t _r	—	4	18	μs	V _{CE} =2V, I _C =2mA R _L =100Ω
	Response Time (Fall)	t _f	—	3	18	μs	

$$* \text{ CTR} = \frac{I_C}{I_F} \times 100\%$$

RANK TABLE OF CURRENT TRANSFER RATIO CTR

MODEL NO.	RANK MARK	CTR (%)
LTV817-V	L	50 ~ 100
	A	80 ~ 160
	B	130 ~ 260
	C	200 ~ 400
	D	300 ~ 600
	L or A or B or C or D or No mark	50 ~ 600
LTV827-V LTV847-V	B	130 ~ 260
	B or C or BC	130 ~ 400
	C	200 ~ 400
	C or D or CD	200 ~ 600
	B、 BC、 C、 CD or No mark	50 ~ 600

CONDITIONS	$I_F = 5 \text{ mA}$ $V_{CE} = 5 \text{ V}$ $T_a = 25 \text{ }^\circ\text{C}$
-------------------	---

ISOLATION SPECIFICATION ACCORDING TO VDE 0884

Parameter	Symbol	Conditions	Rating	Unit	Remark
Class of environmental test	-	DIN IEC68	30/100/21	-	
Pollution	-	DIN VDE0110	2	-	
Maximum Operating Isolation Voltage	V_{IORM}	-	850	V_{PEAK}	Refer to the Diagram 1, 2
Partial Discharge Test Voltage (Between Input and Output)	Diagram 1	V_{pr}	$t_p=60s, q_c<5pC$	V_{PEAK}	
	Diagram 2		$t_p=1s, q_c<5pC$	V_{PEAK}	
Maximum Over-voltage	$V_{INITIAL}$	$t_{INI} = 10s$	6000	V_{PEAK}	
Safety Maximum Ratings					
1) Case Temperature	T_{si}	$I_F = 0, P_c = 0$	175	$^{\circ}C$	Refer to the Figure 1, 3
2) Input Current	I_{si}	$P_c=0$	400	mA	
3) Electric Power (Output or Total Power Issipation)	P_{si}	-	700	mW	
Isolation Resistance (Test Voltage Between Input and Output : DC500V)	R_{ISO}	$T_a=T_{si}$	MIN. 10^9	Ω	
		$T_a=T_{opr}(MAX.)$	MIN. 10^{11}		
		$T_a=25^{\circ}C$	MIN. 10^{12}		

Precautions in performing isolation test

* Partial discharge test methods shall be the ones according to the specifications of VDE 0884:1992-06

* Please don't carry out isolation test (V_{iso}) over $V_{INITIAL}$, This product deteriorates isolation characteristics by partial discharge due to applying high voltage (ex. $V_{INITIAL}$). And there is possibility that this product occurs partial discharge in operating isolation voltage (V_{IORM})

PARTIAL DISCHARGE TEST METHOD

Method (A) for type testing and random testing.

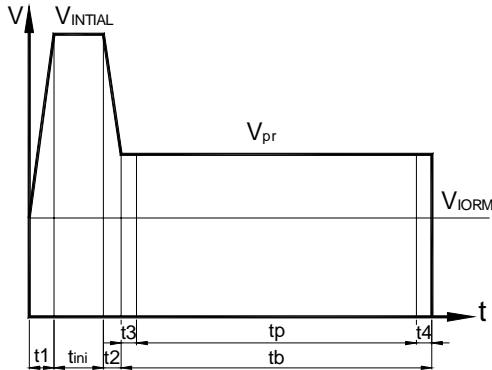

$t1, t2$ = 1 to 10s
 $t3, t4$ = 1s
 t_p (Partial Discharge Measuring Time) = 60s
 t_b = 62s
 t_{ini} = 10s

Method (B) for routine testing.

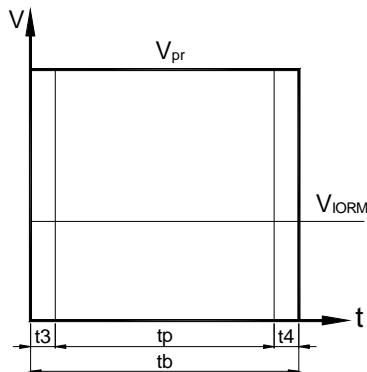

$t3, t4$ = 0.1s
 t_p (Partial Discharge Measuring Time) = 1s
 t_b = 1.2s

The partial discharge level shall not exceed 5 pC during the partial discharge measuring time interval t_p under the test conditions shown above.

CHARACTERISTICS CURVES

Fig.1 Forward Current vs. Ambient Temperature

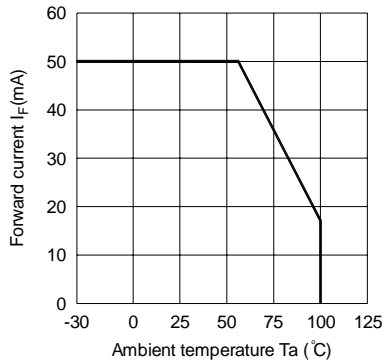

Fig.2 Collector Power Dissipation vs. Ambient Temperature

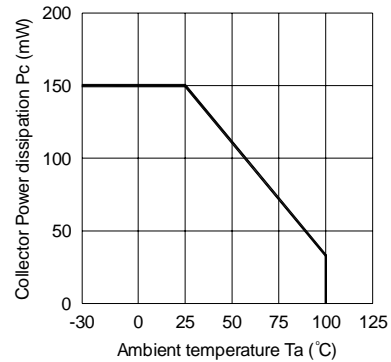

Fig.3 Collector-emitter Saturation Voltage vs. Forward Current

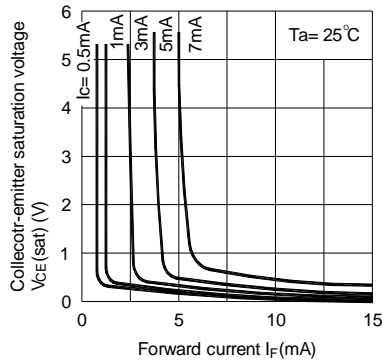

Fig.4 Forward Current vs. Forward Voltage

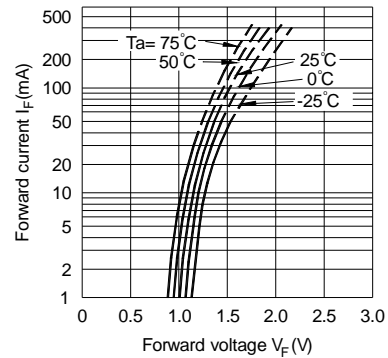

Fig.5 Current Transfer Ratio vs. Forward Current

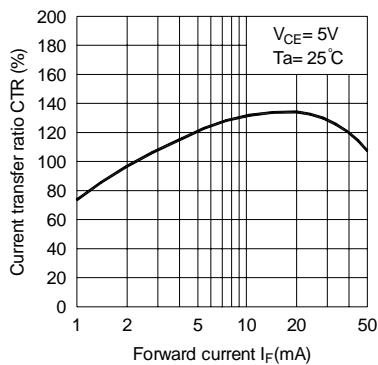
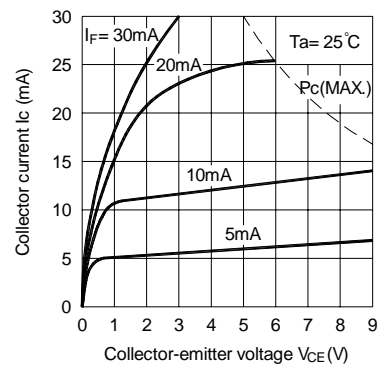

Fig.6 Collector Current vs. Collector-emitter Voltage



CHARACTERISTICS CURVES

Fig.7 Relative Current Transfer Ratio vs. Ambient Temperature

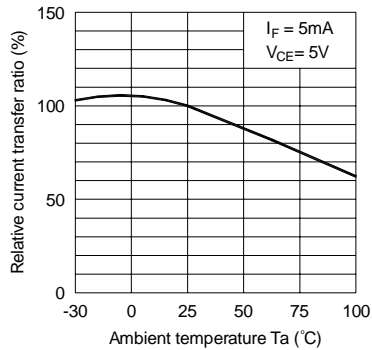

Fig.8 Collector-emitter Saturation Voltage vs. Ambient Temperature

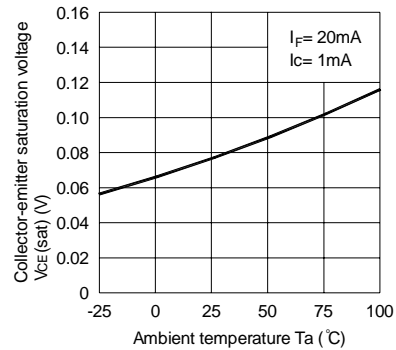

Fig.9 Collector Dark Current vs. Ambient Temperature

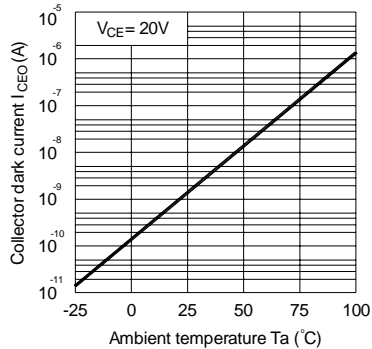

Fig.10 Response Time vs. Load Resistance

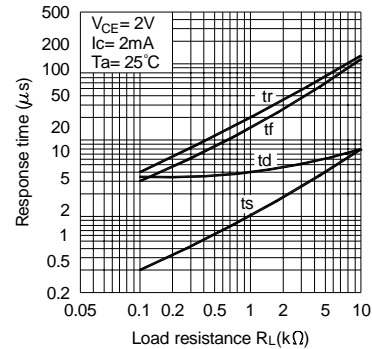
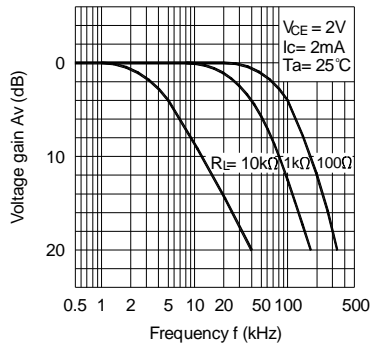
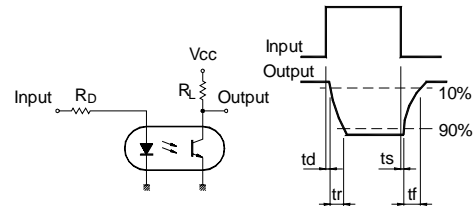

Fig.11 Frequency Response



Test Circuit for Response Time



Test Circuit for Frequency Response

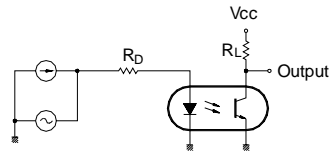

RECOMMENDED FOOT PRINT PATTERNS (MOUNT PAD)

Unit : mm

4 PIN

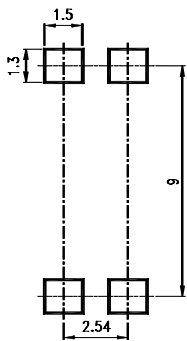

8 PIN

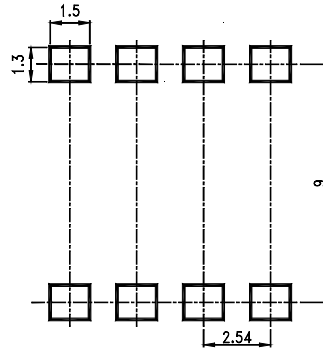

16 PIN

