

4

3

2

1

THIS DRAWING IS UNPUBLISHED. RELEASED FOR PUBLICATION  
COPYRIGHT 20 BY TYCO ELECTRONICS CORPORATION. ALL RIGHTS RESERVED.

LOC	DIST	REVISIONS			
P	LTR	DESCRIPTION	DATE	DWN	APVD
4	-	REVISED PER ECR-10-013879	01JUL2010	SYJ	LSF

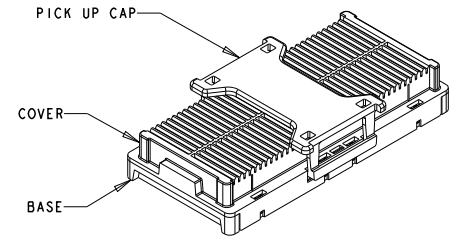
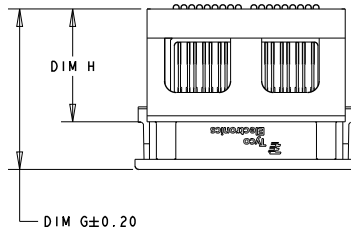
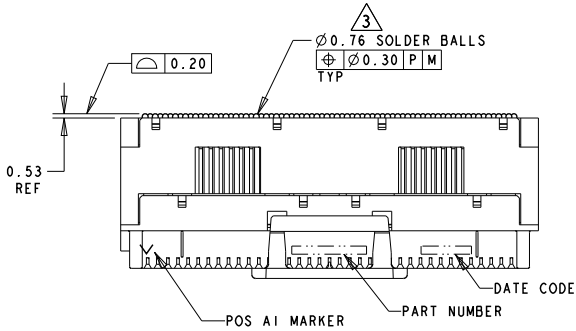

TYPICAL ASSEMBLY  
15mm SHOWN  
SCALE 2:1

ISOMETRIC VIEW  
TYPICAL CONFIGURATION  
FOR 5mm ASSEMBLY  
SCALE 3:2

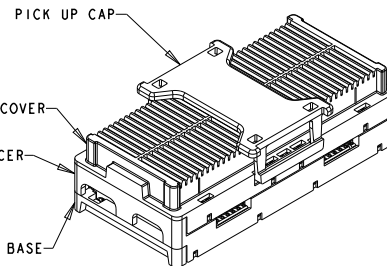
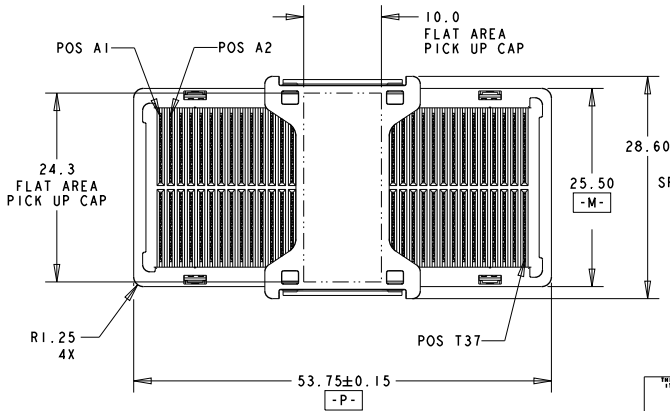

ISOMETRIC VIEW  
TYPICAL CONFIGURATION  
FOR 11mm ASSEMBLY  
SCALE 3:2

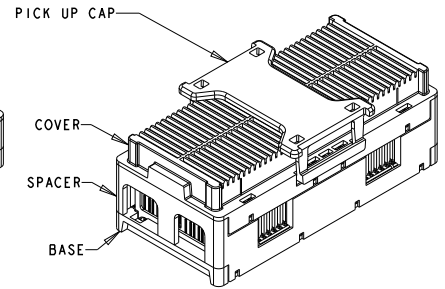

ISOMETRIC VIEW  
TYPICAL CONFIGURATION  
FOR 15mm ASSEMBLY  
SCALE 3:2

<small>THIS DRAWING IS A CONTROLLED DOCUMENT FOR TYCO ELECTRONICS CORPORATION IT IS SUBJECT TO CHANGE AND THE CONTROLLING ENGINEERING ORGANIZATION SHOULD BE CONTACTED FOR THE LATEST REVISION.</small>		DWN P BRANDBERG 11JAN05 CHK D WERTZ 12JAN05 APVD D WERTZ 12JAN05	Tyco Electronics Singapore
DIMENSIONS: mm		TOLERANCES UNLESS OTHERWISE SPECIFIED: 0 PLC ± 1 PLC ±0.3 2 PLC ±0.10 3 PLC ±0.050 4 PLC ± ANGLES ±°	NAME STEP-Z RECEPTACLE ASSEMBLY, 296 SIGNAL POSITION - SIZE CAGE CODE DRAWING NO RESTRICTED TO A3 00779 C-1761617 -
MATERIAL 1		FINISH 2	WEIGHT 114-13101 CUSTOMER DRAWING SCALE - SHEET 1 OF 4 REV B4

4

3

2

1

THIS DRAWING IS UNPUBLISHED. RELEASED FOR PUBLICATION 20  
 © COPYRIGHT 20 BY TYCO ELECTRONICS CORPORATION. ALL RIGHTS RESERVED.

LOC	DIST	REVISIONS			
P	LTR	DESCRIPTION	DATE	DWN	APVD
-	-	SEE SHEET 1	-	-	-

- 1 MATERIAL:  
 BASE, SPACER, COVER: THERMOPLASTIC  
 PICK UP CAP: THERMOPLASTIC  
 CONTACT: COPPER ALLOY  
 SOLDER BALL: Sn/Pb FOR P/N 1761617-1 THRU 5-1761617-0  
 Sn/Ag FOR P/N 5-1761617-1 THRU 9-1761617-9
- 2 FINISH:  
 CONTACT: 0.00076 MIN GOLD OVER 0.00127 MIN NICKEL.  
 (30µ" MIN GOLD OVER 50µ" MIN NICKEL)
- 3 SOLDER BALLS WILL NOT BE PERFECT  
 SPHERICAL SHAPE DUE TO REFLOW ATTACHMENT.
- 4 CONTACTS IN ROWS A,C,E,G,J,K,M,P,R, AND T  
 ARE SINGLE BEAM CONTACTS.  
 TYPICALLY USED AS GROUND PINS.  
 (NOTE: CONTACTS IN ROWS J & K ARE TIED  
 TOGETHER [COMMONED]).
- 5 CONTACTS IN ROWS B,D,F,H,L,N,O, AND S  
 ARE DUAL BEAM CONTACTS.  
 TYPICALLY USED AS SIGNAL PINS.
- 6 SPECIFIED POSITIONAL TOLERANCE DEFINES PAD TO PAD  
 LOCATION WITHIN LAND PATTERN. POSITIONAL TOLERANCE  
 OF LAND PATTERN TO FUDICIAL MARKS OR PCB DATUMS  
 SHALL BE DEFINED BY CUSTOMER. FOR RECOMMENDED  
 PRODUCT APPLICATION AND PCB DESIGN DETAILS, SEE  
 APPLICATION SPEC 114-13101.

DIM H	DIM G	LOAD STYLE	DESCRIPTION	PART NUMBER
14.51	20.65	-	15mm Sn/Ag	6-1761617-5
10.51	16.65	-	11mm Sn/Ag	6-1761617-1
4.51	10.65	-	5mm Sn/Ag	5-1761617-5
14.51	20.65	-	15mm Sn/Pb	1-1761617-5
10.51	16.65	-	11mm Sn/Pb	1-1761617-1
4.51	10.65	-	5mm Sn/Pb	1761617-5

<small>THIS DRAWING IS A CONTROLLED DOCUMENT FOR TYCO ELECTRONICS CORPORATION          IT IS SUBJECT TO CHANGE AND THE CONTROLLING ENGINEERING ORGANIZATION          SHOULD BE CONTACTED FOR THE LATEST REVISION.</small>		DWN P BRANDBERG 11 JAN05 CHK D WERTZ 12 JAN05 APVD D WERTZ 12 JAN05	Tyco Electronics Singapore
DIMENSIONS: mm	TOLERANCES UNLESS OTHERWISE SPECIFIED: 0 PLC ±. 1 PLC ±0.3 2 PLC ±0.10 3 PLC ±0.050 4 PLC ±. ANGLES ±2°	NAME STEP-Z RECEPTACLE ASSEMBLY, 296 SIGNAL POSITION	RESTRICTED TO
	MATERIAL - FINISH -	APPLICATION SPEC - WEIGHT - SIZE A3 CAGE CODE C=1761617	CUSTOMER DRAWING
AMP 1470-19 REV 31MAR2000		SCALE - SHEET 2 OF 4 REV B4	

4

3

2

1

THIS DRAWING IS UNPUBLISHED. RELEASED FOR PUBLICATION 20  
 © COPYRIGHT 20 BY TYCO ELECTRONICS CORPORATION. ALL RIGHTS RESERVED.

LOC	DIST	REVISIONS			
P	LTR	DESCRIPTION	DATE	DWN	APVD
DY	-	SEE SHEET 1	-	-	-

KEY ORIENTATION  
SILK-SCREEN  
(OPTIONAL)

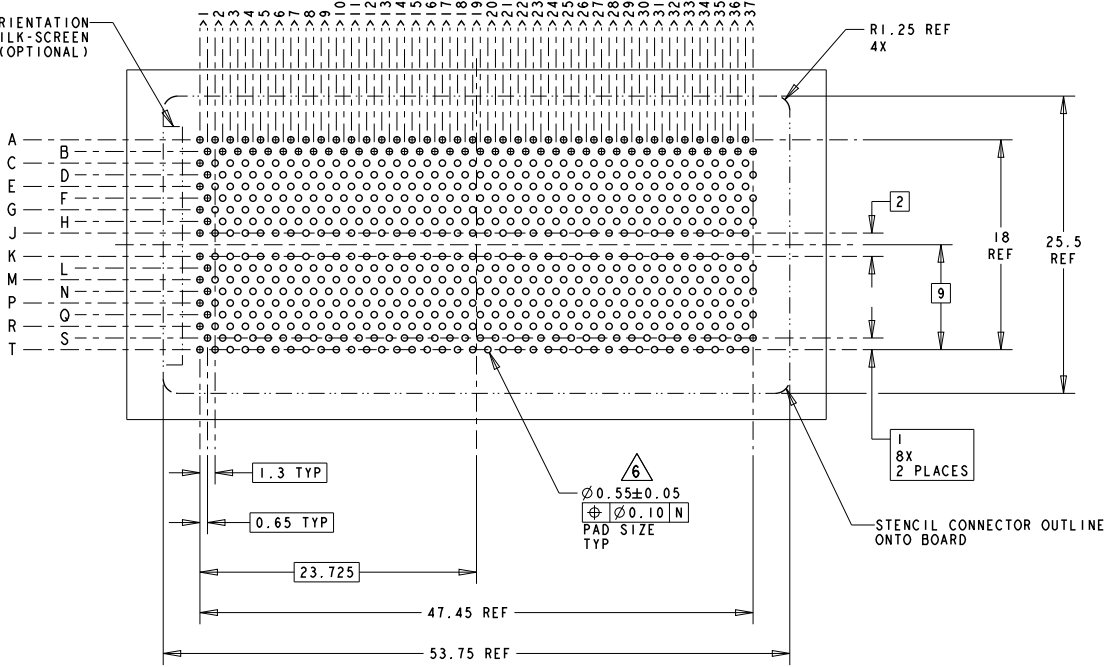

**4 5 BOARD PATTERN**  
SCALE 3:1

THIS DRAWING IS A CONTROLLED DOCUMENT FOR TYCO ELECTRONICS CORPORATION. IT IS SUBJECT TO CHANGE AND THE CONTROLLING ENGINEERING ORGANIZATION SHOULD BE CONTACTED FOR THE LATEST REVISION.

DIMENSIONS:	TOLERANCES UNLESS OTHERWISE SPECIFIED:
mm	0 PLC ±
	1 PLC ±0.3
	2 PLC ±0.10
	3 PLC ±0.050
	4 PLC ±
	ANGLES ±2°
MATERIAL -	FINISH -

DWN P BRANDBERG 11 JAN 05	Tyco Electronics Singapore	NAME STEP-Z RECEPTACLE ASSEMBLY, 296 SIGNAL POSITION	RESTRICTED TO
CHK D WERTZ 12 JAN 05			
APVD D WERTZ 12 JAN 05	SIZE A3	CAGE CODE 00779	DRAWING NO C-1761617
PRODUCT SPEC -	APPLICATION SPEC -	WEIGHT -	CUSTOMER DRAWING
SCALE -		SHEET 3 OF 4	REV B4

4

3

2

1

THIS DRAWING IS UNPUBLISHED. RELEASED FOR PUBLICATION 20  
© COPYRIGHT 20 BY TYCO ELECTRONICS CORPORATION. ALL RIGHTS RESERVED.

LOC	DIST	REVISIONS			
P	LTR	DESCRIPTION	DATE	DWN	APVD
-	-	SEE SHEET 1	-	-	-

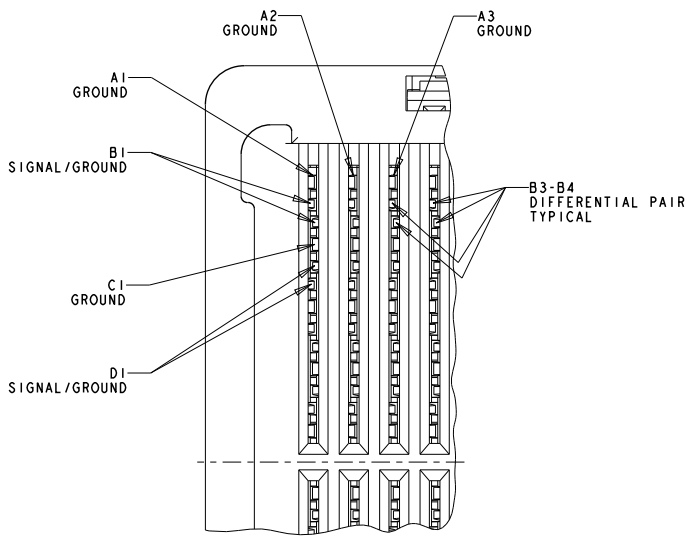

RECEPTACLE INTERFACE  
SCALE 8:1

<small>THIS DRAWING IS A CONTROLLED DOCUMENT FOR TYCO ELECTRONICS CORPORATION IT IS SUBJECT TO CHANGE AND THE CONTROLLING ENGINEERING ORGANIZATION SHOULD BE CONTACTED FOR THE LATEST REVISION.</small>		DWN P BRANDBERG 11 JAN 05 CHK D WERTZ 12 JAN 05 APVD D WERTZ 12 JAN 05	
DIMENSIONS: mm 	TOLERANCES UNLESS OTHERWISE SPECIFIED: 0 PLC ±. 1 PLC ±0.3 2 PLC ±0.10 3 PLC ±0.050 4 PLC ±. ANGLES ±2°	NAME STEP-Z RECEPTACLE ASSEMBLY, 296 SIGNAL POSITION PRODUCT SPEC APPLICATION SPEC WEIGHT	SIZE CAGE CODE DRAWING NO RESTRICTED TO A3 00779 C=1761617 -
MATERIAL -	FINISH -	CUSTOMER DRAWING	SCALE - SHEET 4 OF 4 REV B4

AMP 1470-19 REV 31MAR2000