

THIS DRAWING IS UNPUBLISHED. RELEASED FOR PUBLICATION
 BY TYCO ELECTRONICS CORPORATION. ALL RIGHTS RESERVED.

LOC		DIST		REVISIONS			
P	LTR	DESCRIPTION	DATE	DWN	APVD		
DY	-						
A3		REVISED PER ECR-10-013879	20JUN2010	SYJ	LSF		

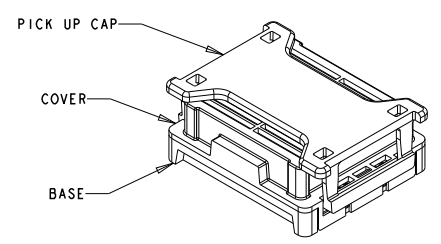
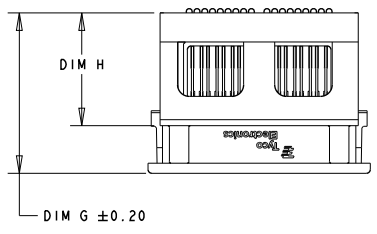
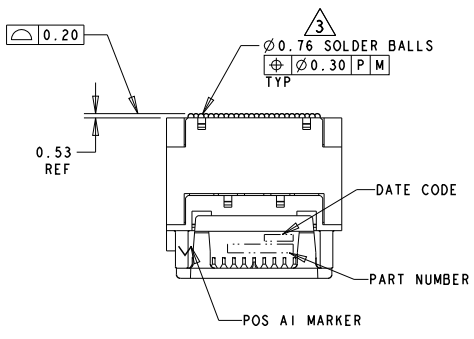

ISOMETRIC VIEW
 TYPICAL CONFIGURATION
 FOR 5mm ASSEMBLY
 SCALE 2:1

TYPICAL ASSEMBLY
 15mm SHOWN
 SCALE 2:1

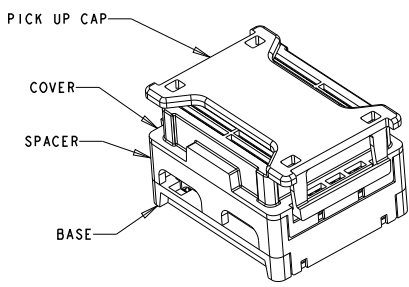
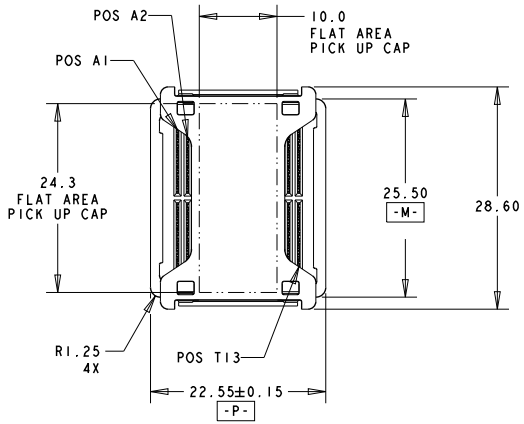

ISOMETRIC VIEW
 TYPICAL CONFIGURATION
 FOR 11mm ASSEMBLY
 SCALE 2:1

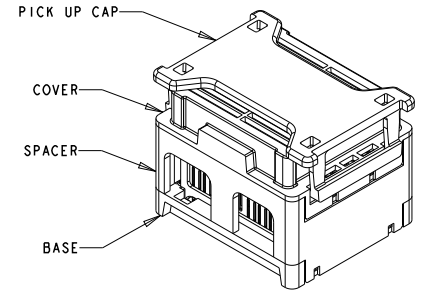

ISOMETRIC VIEW
 TYPICAL CONFIGURATION
 FOR 15mm ASSEMBLY
 SCALE 2:1

<small>THIS DRAWING IS A CONTROLLED DOCUMENT FOR TYCO ELECTRONICS CORPORATION. IT IS SUBJECT TO CHANGE AND THE CONTROLLING ENGINEERING ORGANIZATION SHOULD BE CONTACTED FOR THE LATEST REVISION.</small>		DWN P BRANDBERG	19 JAN 05		Tyco Electronics Singapore
		CHK D WERTZ	20 JAN 05		
		APVD D WERTZ	20 JAN 05	NAME STEP-Z, RECEPTACLE ASSEMBLY, 104 SIGNAL POSITION	
DIMENSIONS: mm		TOLERANCES UNLESS OTHERWISE SPECIFIED: 0 PLC ±. 1 PLC ±0.3 2 PLC ±0.10 3 PLC ±0.050 4 PLC ±. ANGLES ±°		PRODUCT SPEC 108-2143	
MATERIAL 		FINISH 		APPLICATION SPEC 114-13101	
		WEIGHT -		SIZE A3	CAGE CODE 00779
		CUSTOMER DRAWING		DRAWING NO C-1761613	RESTRICTED TO -
				SCALE -	SHEET 1 OF 3
				REV A3	

4

3

2

1

THIS DRAWING IS UNPUBLISHED. RELEASED FOR PUBLICATION 20
 © COPYRIGHT 20 BY TYCO ELECTRONICS CORPORATION. ALL RIGHTS RESERVED.

LOC	DIST	REVISIONS			
P	LTR	DESCRIPTION	DATE	DWN	APVD
-	-	SEE SHEET 1	-	-	-

- 1 MATERIAL:
 BASE, SPACER, COVER: THERMOPLASTIC
 PICK UP CAP: THERMOPLASTIC
 CONTACT: COPPER ALLOY
 SOLDER BALL: Sn/Pb FOR P/N 1761613-1 THRU 5-1761613-0
 Sn/Ag FOR P/N 5-1761613-1 THRU 9-1761613-9
- 2 FINISH:
 CONTACT: 0.00076 MIN GOLD OVER 0.00127 MIN NICKEL.
 (30µ" MIN GOLD OVER 50µ" MIN NICKEL)
- 3 SOLDER BALLS WILL NOT BE PERFECT
 SPHERICAL SHAPE DUE TO REFLOW ATTACHMENT.
- 4 CONTACTS IN ROWS A,C,E,G,J,K,M,P,R, AND T
 ARE SINGLE BEAM CONTACTS.
 TYPICALLY USED AS GROUND PINS.
 (NOTE: CONTACTS IN ROWS J & K ARE TIED
 TOGETHER [COMMONED]).
- 5 CONTACTS IN ROWS B,D,F,H,L,N,O, AND S
 ARE DUAL BEAM CONTACTS.
 TYPICALLY USED AS SIGNAL PINS.
- 6 SPECIFIED POSITIONAL TOLERANCE DEFINES PAD TO PAD
 LOCATION WITHIN LAND PATTERN. POSITIONAL TOLERANCE
 OF LAND PATTERN TO FUDICIAL MARKS OR PCB DATUMS
 SHALL BE DEFINED BY CUSTOMER. FOR RECOMMENDED
 PRODUCT APPLICATION AND PCB DESIGN DETAILS, SEE
 APPLICATION SPEC 114-13101.

14.51	20.65	-	15mm Sn/Ag	6-1761613-5
10.51	16.65	-	11mm Sn/Ag	6-1761613-1
4.51	10.65	-	5mm Sn/Ag	5-1761613-5
14.51	20.65	-	15mm Sn/Pb	1-1761613-5
10.51	16.65	-	11mm Sn/Pb	1-1761613-1
4.51	10.65	-	5mm Sn/Pb	1761613-5
DIM H	DIM G	LOAD STYLE	DESCRIPTION	PART NUMBER

<small>THIS DRAWING IS A CONTROLLED DOCUMENT FOR TYCO ELECTRONICS CORPORATION IT IS SUBJECT TO CHANGE AND THE CONTROLLING ENGINEERING ORGANIZATION SHOULD BE CONTACTED FOR THE LATEST REVISION.</small>		DWN P BRANDBERG 19 JAN 05 CHK D WERTZ 20 JAN 05 APVD D WERTZ 20 JAN 05 PRODUCT SPEC - APPLICATION SPEC - WEIGHT -	Tyco Electronics Tyco Electronics Singapore NAME STEP-Z, RECEPTACLE ASSEMBLY, 104 SIGNAL POSITION SIZE CAGE CODE DRAWING NO A3 00779 C=1761613 RESTRICTED TO -
DIMENSIONS: mm 	TOLERANCES UNLESS OTHERWISE SPECIFIED: 0 PLC ±. 1 PLC ±0.3 2 PLC ±0.10 3 PLC ±0.050 4 PLC ±. ANGLES ±2° MATERIAL - FINISH -	CUSTOMER DRAWING	SCALE - SHEET 2 OF 3 REV A3

THIS DRAWING IS UNPUBLISHED. RELEASED FOR PUBLICATION
 © COPYRIGHT 20 BY TYCO ELECTRONICS CORPORATION. ALL RIGHTS RESERVED.

LOC	DIST	REVISIONS			
P	LTR	DESCRIPTION	DATE	DWN	APVD
DY	-	SEE SHEET 1	-	-	-

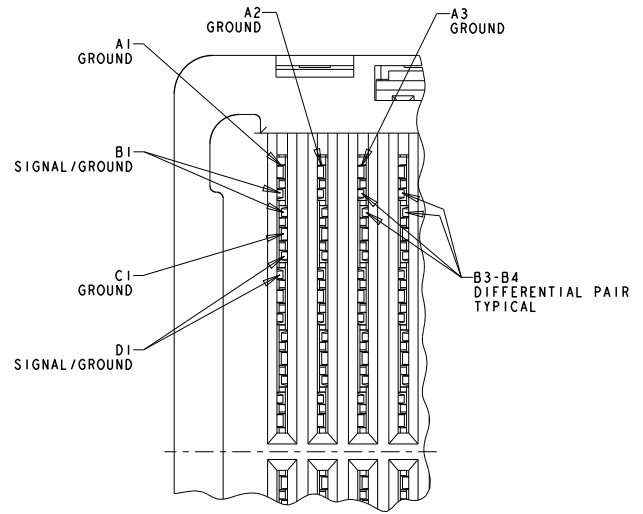
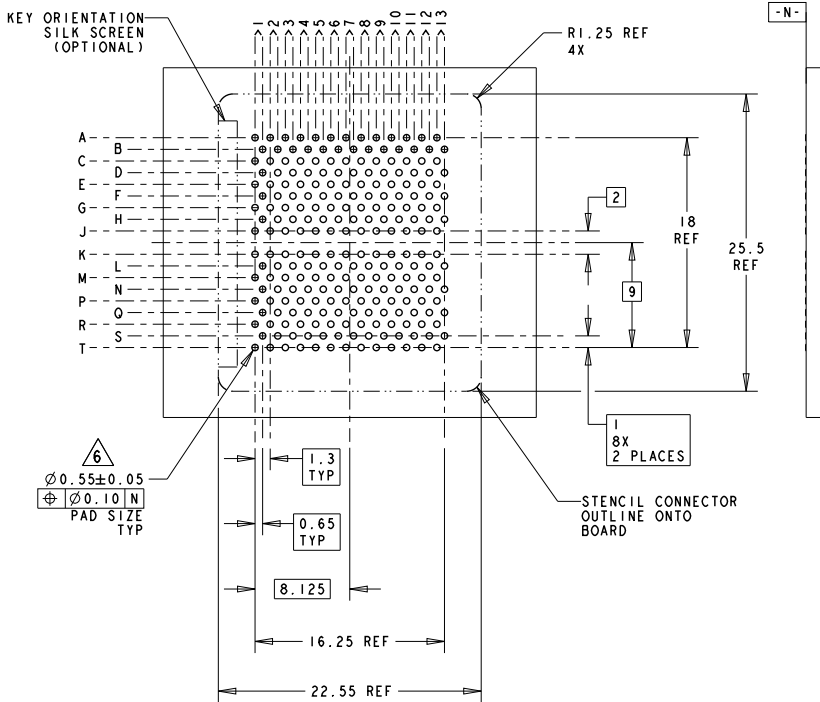

RECEPTACLE INTERFACE
 SCALE 8:1

4 5 BOARD PATTERN
 SCALE 3:1

<small>THIS DRAWING IS A CONTROLLED DOCUMENT FOR TYCO ELECTRONICS CORPORATION IT IS SUBJECT TO CHANGE AND THE CONTROLLING ENGINEERING ORGANIZATION SHOULD BE CONTACTED FOR THE LATEST REVISION.</small>		DWN P BRANDBERG 19 JAN 05 CHK D WERTZ 20 JAN 05 APVD D WERTZ 20 JAN 05	Tyco Electronics Singapore
DIMENSIONS: mm	TOLERANCES UNLESS OTHERWISE SPECIFIED: 0 PLC ±. 1 PLC ±0.3 2 PLC ±0.10 3 PLC ±0.050 4 PLC ±. ANGLES ±2°	NAME STEP-Z, RECEPTACLE ASSEMBLY, 104 SIGNAL POSITION	RESTRICTED TO -
MATERIAL -	FINISH -	APPLICATION SPEC - WEIGHT - CUSTOMER DRAWING	SIZE A3 CAGE CODE 00779 DRAWING NO C-1761613
		SCALE -	SHEET 3 OF 3 REV A3