



# High Transfer Efficiency AC Input Type Photocoupler

## LTV-8141 Series

### Features

- AC input response
- High current transfer ratio  
(CTR : MIN. 600% at  $I_F = \pm 1\text{mA}$ ,  $V_{CE} = 2\text{V}$ )
- High input-output isolation voltage:  
( $V_{ISO} : 5,000\text{V}_{rms}$ )
- Compact dual-in-line package  
LTV-8141 : 1-channel type  
LTV-8241 : 2-channel type  
LTV-8441 : 4-channel type
- UL approved (No. E113898)
- TUV approved (No. R9653630)
- CSA approved (No. CA91533-1)
- FIMKO approved (No. 193422)
- NEMKO approved (No. P96103013)
- DEMKO approved (No. 303986)
- SEMKO approved (No. 9646047/01-30)
- Options available :  
-Leads with 0.4"(10.16mm)spacing (M Type)  
-Leads bends for surface mounting(S Type)  
-Tape and Reel of Type I for SMD(Add"-TA"Suffix)  
-Tape and Reel of Type II for SMD(Add"-TA1"Suffix)

### Applications

1. System appliances, measuring instruments.
2. Industrial robots.
3. Copiers, automatic vending machines.
4. Signal transmission between circuits of different potentials and impedances.

### Package Dimensions

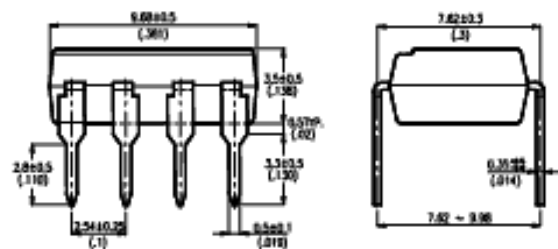
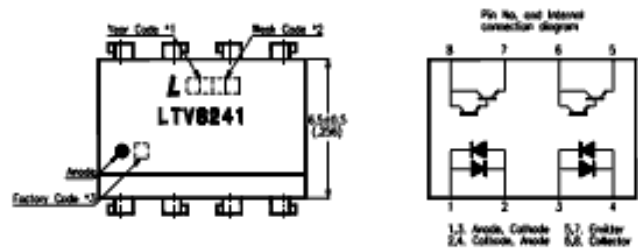
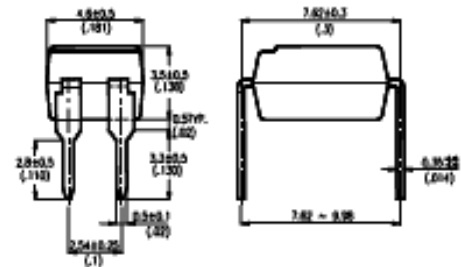
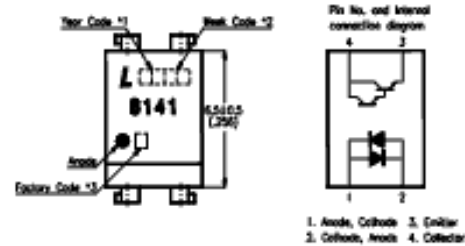

PHOTOCOUPLER

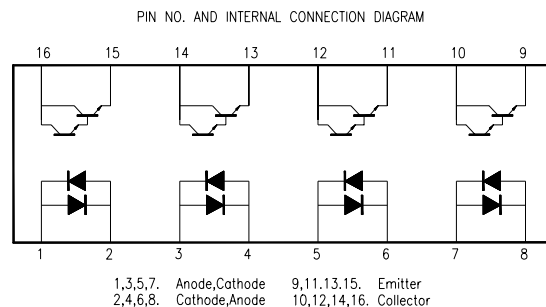
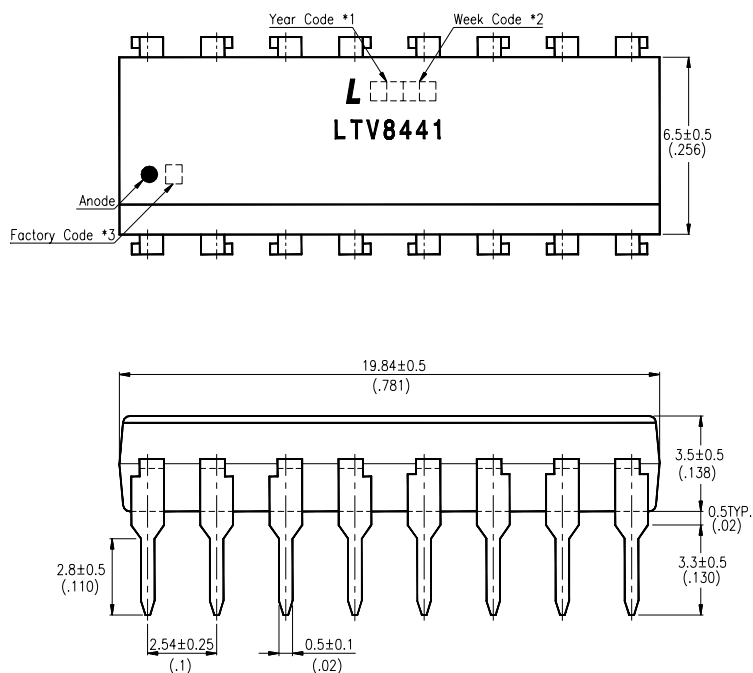

1,3,5,7. Anode,Cathode  
2,4,6,8. Cathode,Anode  
9,11,13,15. Emitter  
10,12,14,16. Collector

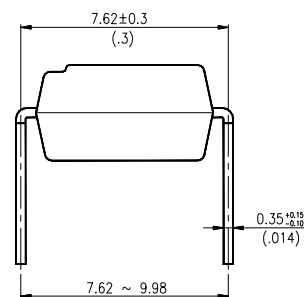

**Note:**

1. Year date code.
2. 2-digit work week.
3. Factory code shall be marked (Z : Taiwan, Y : Thailand).
4. All dimensions are in millimeters (inches).
5. Tolerance is  $\pm 0.25\text{mm}$  (.010") unless otherwise noted.
6. Specifications are subject to change without notice.

**Ordering Information**

Part Number	Package	Safety Standard Approval	Application part number
LTV-8141 LTV-8141M LTV-8141S LTV-8141S-TA LTV-8141S-TA1	4-pin DIP 4-pin (leads with 0.4" spacing) 4-pin (lead bends for surface mount) 4-pin (tape and reel packaging of type I) 4-pin (tape and reel packaging of type II)	<ul style="list-style-type: none"> <li>• UL approved</li> <li>• TUV approved</li> <li>• CSA approved</li> <li>• FIMKO approved</li> <li>• NEMKO approved</li> <li>• SEMKO approved</li> <li>• DEMKO approved</li> </ul>	LTV-8141
LTV-8241 LTV-8241M LTV-8241S LTV-8241S-TA LTV-8241S-TA1	8-pin DIP 8-pin (leads with 0.4" spacing) 8-pin (lead bends for surface mount) 8-pin (tape and reel packaging of type I) 8-pin (tape and reel packaging of type II)		LTV-8241
LTV-8441 LTV-8441M LTV-8441S LTV-8441S-TA LTV-8441S-TA1	16-pin DIP 16-pin (leads with 0.4" spacing) 16-pin (lead bends for surface mount) 16-pin (tape and reel packaging of type I) 16-pin (tape and reel packaging of type II)		LTV-8441
LTV8141-V LTV8141M-V LTV8141S-V LTV8141STA-V LTV8141STA1-V	4-pin DIP 4-pin (leads with 0.4" spacing) 4-pin (lead bends for surface mount) 4-pin (tape and reel packaging of type I) 4-pin (tape and reel packaging of type II)	<ul style="list-style-type: none"> <li>• VDE approved</li> </ul>	LTV-8141
LTV8241-V LTV8241M-V LTV8241S-V LTV8241STA-V LTV8241STA1-V	8-pin DIP 8-pin (leads with 0.4" spacing) 8-pin (lead bends for surface mount) 8-pin (tape and reel packaging of type I) 8-pin (tape and reel packaging of type II)		LTV-8241
LTV8441-V LTV8441M-V LTV8441S-V LTV8441STA-V LTV8441STA1-V	16-pin DIP 16-pin (leads with 0.4" spacing) 16-pin (lead bends for surface mount) 16-pin (tape and reel packaging of type I) 16-pin (tape and reel packaging of type II)		LTV-8441

## Absolute Maximum Ratings

(Ta=25°C)

Parameter		Symbol	Rating	Unit
Input	Forward Current	I <sub>F</sub>	± 50	mA
	Power Dissipation	P	70	mW
Output	Collector-Emitter Voltage	V <sub>CEO</sub>	35	V
	Emitter-Collector Voltage	V <sub>ECO</sub>	6	V
	Collector Current	I <sub>C</sub>	80	mA
	Collector Power Dissipation	P <sub>C</sub>	150	mW
Total Power Dissipation		P <sub>tot</sub>	200	mW
Operating Temperature		T <sub>opr</sub>	-30~+100	°C
Storage Temperature		T <sub>stg</sub>	-55~+125	°C
*1.Isolation Voltage		V <sub>iso</sub>	5	KV <sub>rms</sub>
*2.Soldering Temperature		T <sub>sol</sub>	260	°C

\*1. AC for 1 minute, R.H. = 40 ~ 60%

• Isolation voltage shall be measured using the following method.

- (1) Short between anode and cathode on the primary side and between collector, emitter and base on the secondary side.
- (2) The isolation voltage tester with zero-cross circuit shall be used.
- (3) The waveform of applied voltage shall be a sine wave.

\*2. For 10 seconds.

## Electrical/Optical Characteristics

(Ta=25°C)

Parameter		Symbol	Min.	Typ.	Max.	Unit	Conditions
Input	Forward Voltage	V <sub>F</sub>	—	1.2	1.4	V	I <sub>F</sub> = ± 20mA
	Terminal Capacitance	C <sub>t</sub>	—	50	250	pF	V=0, f=1KHz
Output	Collector Dark Current	I <sub>CEO</sub>	—	—	1	μA	V <sub>CE</sub> =10V
	Collector-Emitter Breakdown Voltage	BV <sub>CEO</sub>	35	—	—	V	I <sub>C</sub> =0.1mA
	Emitter-Collector Breakdown Voltage	BV <sub>ECO</sub>	6	—	—	V	I <sub>E</sub> =10 μA
Transfer Characteristics	Collector Current	I <sub>C</sub>	6	—	75	mA	I <sub>F</sub> = ± 1mA V <sub>CE</sub> =2V
	*Current Transfer Ratio	CTR	600	—	7,500	%	
	Collector-emitter Saturation Voltage	V <sub>CE(sat)</sub>	—	0.8	1.0	V	I <sub>F</sub> = ± 20mA, I <sub>C</sub> =5mA
	Isolation Resistance	R <sub>iso</sub>	50	100	—	GΩ	DC500V, 40~60% R.H.
	Floating Capacitance	C <sub>f</sub>	—	0.6	1.0	pF	V=0, f=1MHz
	Cut-off Frequency	f <sub>c</sub>	1	6	—	KHz	V <sub>CE</sub> =5V, I <sub>C</sub> =2mA R <sub>L</sub> =100 Ω, -3dB
	Response Time (Rise)	t <sub>r</sub>	—	60	300	μs	V <sub>CE</sub> =2V, I <sub>C</sub> =10mA
	Response Time (Fall)	t <sub>f</sub>	—	53	250	μs	R <sub>L</sub> =100 Ω

$$*CTR = \frac{I_C}{I_F} \times 100\%$$

# Typical Electrical/Optical Characteristic Curves (25°C Ambient Temperature Unless Otherwise Noted)

**Fig.1 Forward Current vs. Ambient Temperature**

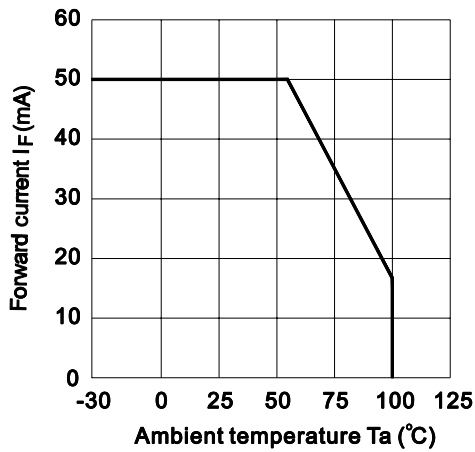

**Fig.2 Collector Power Dissipation vs. Ambient Temperature**

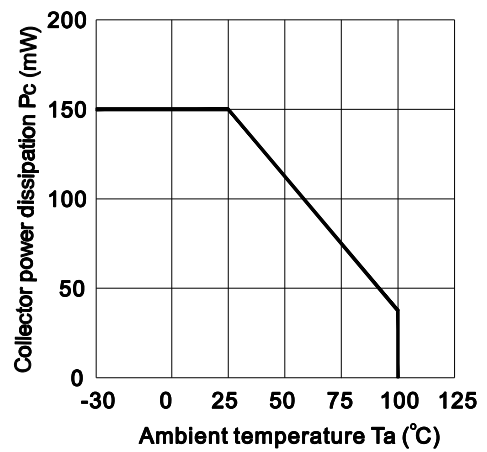

**Fig.3 Collector-emitter Saturation Voltage vs. Forward Current**

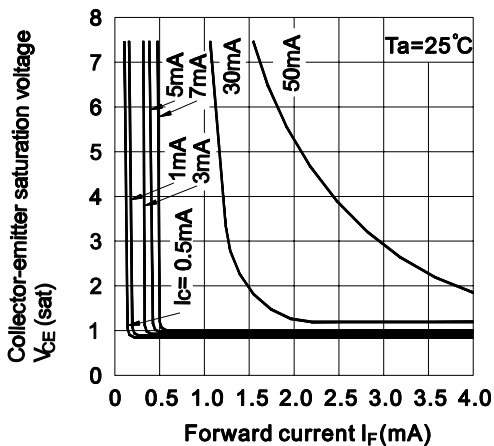

**Fig.4 Forward Current vs. Forward Voltage**

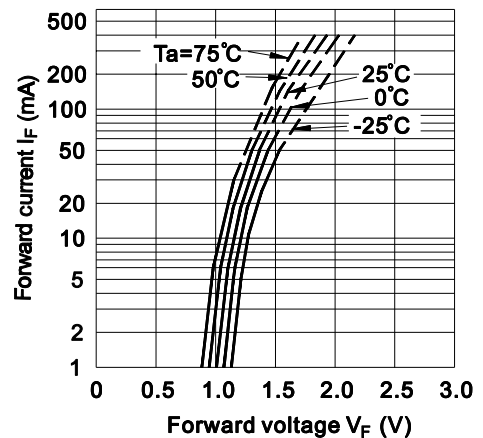

**Fig.5 Current Transfer Ratio vs. Forward Current**

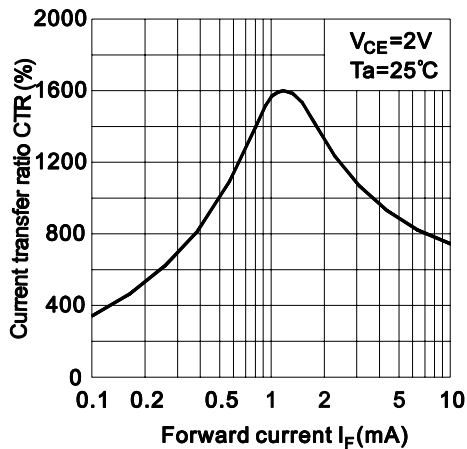

**Fig.6 Collector Current vs. Collector-emitter Voltage**

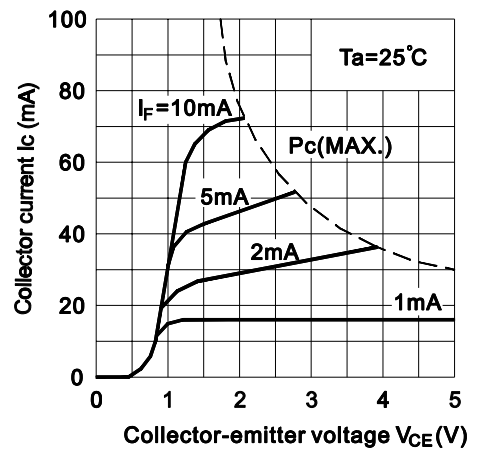

**Fig.7 Relative Current Transfer Ratio vs. Ambient Temperature**

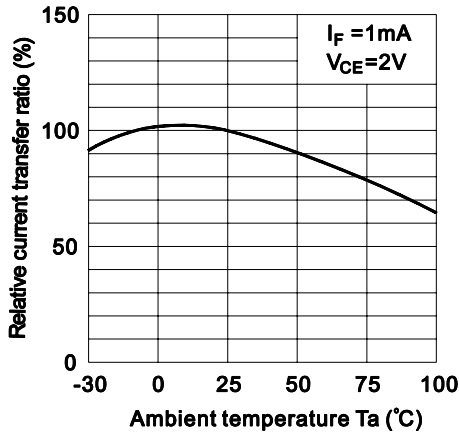

**Fig.8 Collector-emitter Saturation Voltage vs. Ambient Temperature**

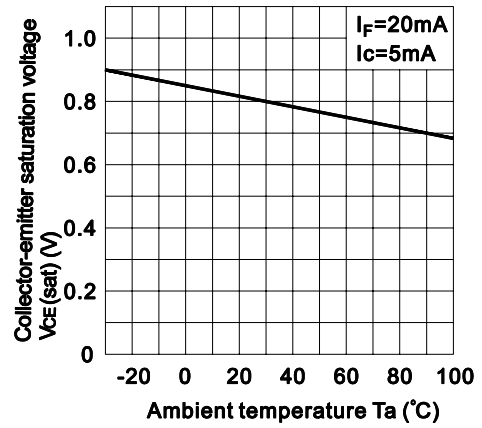

**Fig.9 Collector Dark Current vs. Ambient Temperature**

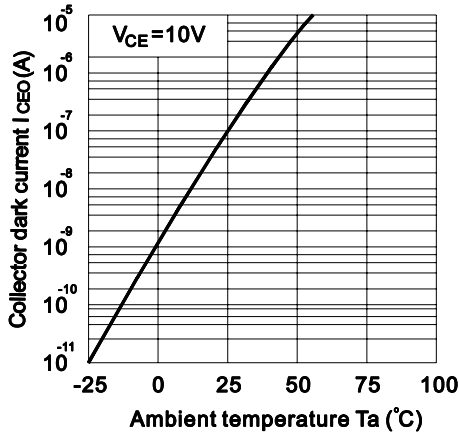

**Fig.10 Response Time vs. Load Resistance**

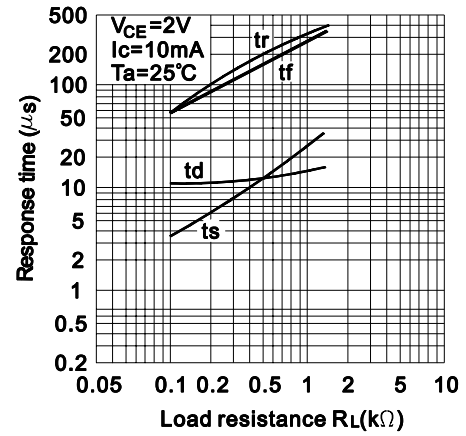

**Fig.11 Frequency Response**

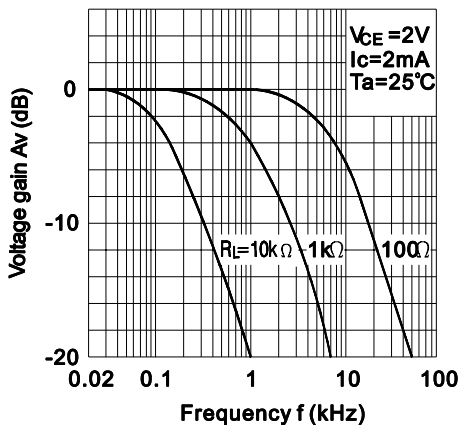

**Test Circuit for Response Time**

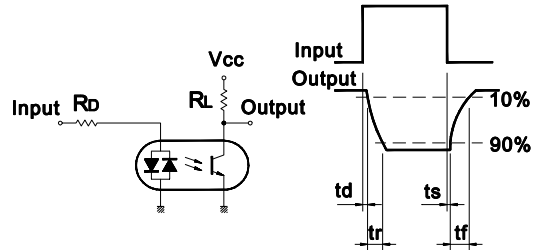

**Test Circuit for Frequency Response**

