

High Density Mounting Type Photocoupler LTV-819 Series

Features

- Current transfer ratio
(CTR : MIN. 50% at $I_F=5mA$, $V_{CE}=5V$)
- High input-output isolation voltage:
($V_{ISO} : 5,000V_{rms}$)
- Compact dual-in-line package
LTV-819-1 : 1-channel type
LTV-819-2 : 1-channel type
LTV-829 : 2-channel type
LTV-849 : 4-channel type
- UL approved (No. E113898)
- TUV approved (No. R9653630)
- CSA approved (No. CA91533-1)
- FIMKO approved (No. 193422)
- NEMKO approved (No. P96103013)
- DEMKO approved (No. 303986)
- SEMKO approved (No. 9646047/01-30)
- VDE approved (No. 094722)
- Options available :
-Leads with 0.4"(10.16mm)spacing (M Type)
-Leads bends for surface mounting(S Type)
-Tape and Reel of Type I for SMD(Add"-TA"Suffix)
-Tape and Reel of Type II for SMD(Add"-TA1"Suffix)
-VDE 0884 approvals (Add"-V"Suffix)

Applications

1. Telephone exchanges.
2. Computer terminals.
3. System appliances, measuring instruments.
4. Signal transmission between circuits of different potentials and impedances.

Package Dimensions

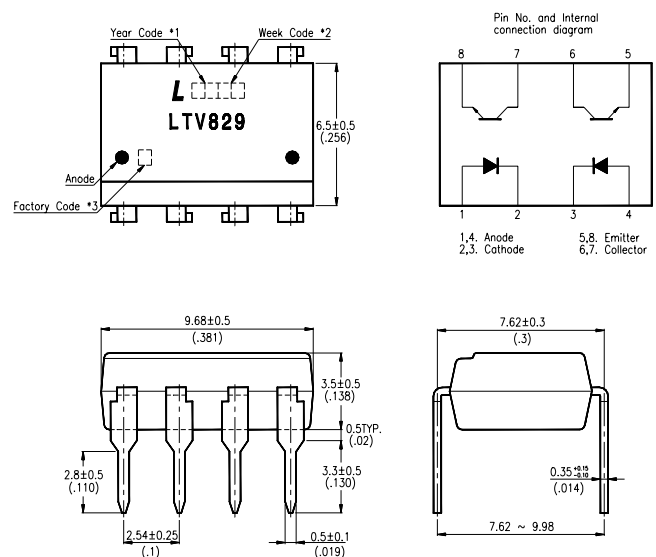
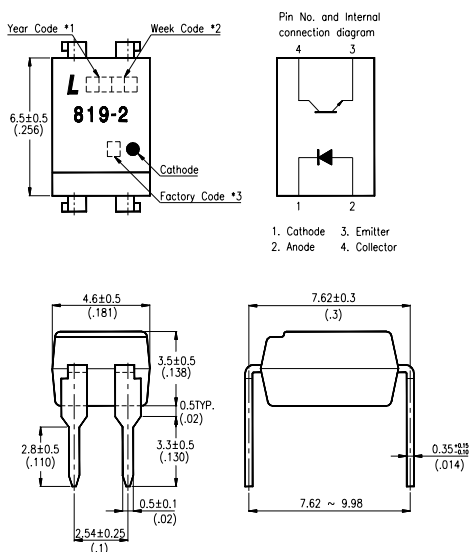
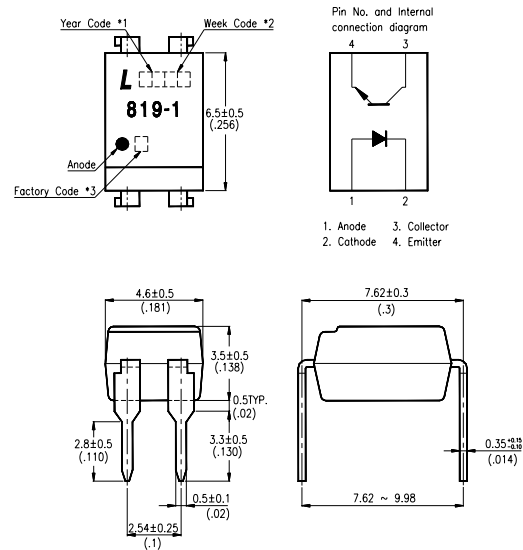

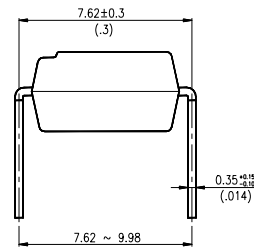
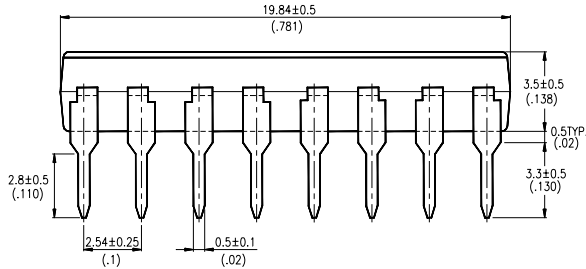
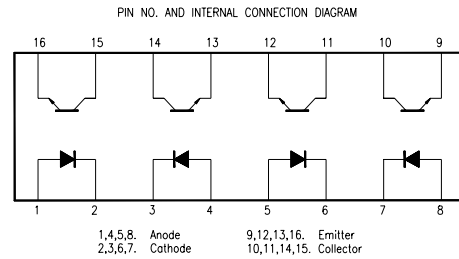
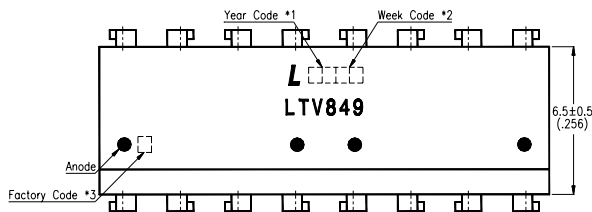

Note:

1. Year date code.
2. 2-digit work week.
3. Factory code shall be marked (Z : Taiwan, Y : Thailand).
4. All dimensions are in millimeters (inches).
5. Tolerance is $\pm 0.25\text{mm}$ (.010") unless otherwise noted.
6. Specifications are subject to change without notice.

Ordering Information

Part Number	Package	Safety Standard Approval	Application part number	
LTV-819-1 LTV-819-1M LTV-819-1S LTV-819-1S-TA LTV-819-1S-TA1	4-pin DIP 4-pin (leads with 0.4" spacing) 4-pin (lead bends for surface mount) 4-pin (tape and reel packaging of type I) 4-pin (tape and reel packaging of type II)	<ul style="list-style-type: none"> • UL approved • TUV approved • CSA approved • FIMKO approved • NEMKO approved • SEMKO approved • DEMKO approved 	LTV-819-1	
LTV-819-2 LTV-819-2M LTV-819-2S LTV-819-2S-TA LTV-819-2S-TA1	4-pin DIP 4-pin (leads with 0.4" spacing) 4-pin (lead bends for surface mount) 4-pin (tape and reel packaging of type I) 4-pin (tape and reel packaging of type II)		LTV-819-2	
LTV-829 LTV-829M LTV-829S LTV-829S-TA LTV-829S-TA1	8-pin DIP 8-pin (leads with 0.4" spacing) 8-pin (lead bends for surface mount) 8-pin (tape and reel packaging of type I) 8-pin (tape and reel packaging of type II)		LTV-829	
LTV-849 LTV-849M LTV-849S LTV-849S-TA LTV-849S-TA1	16-pin DIP 16-pin (leads with 0.4" spacing) 16-pin (lead bends for surface mount) 16-pin (tape and reel packaging of type I) 16-pin (tape and reel packaging of type II)		LTV-849	
LTV8191-V LTV8191M-V LTV8191S-V LTV8191STA-V LTV8191STA1-V	4-pin DIP 4-pin (leads with 0.4" spacing) 4-pin (lead bends for surface mount) 4-pin (tape and reel packaging of type I) 4-pin (tape and reel packaging of type II)		<ul style="list-style-type: none"> • VDE approved 	LTV-819-1
LTV8192-V LTV8192M-V LTV8192S-V LTV8192STA-V LTV8192STA1-V	4-pin DIP 4-pin (leads with 0.4" spacing) 4-pin (lead bends for surface mount) 4-pin (tape and reel packaging of type I) 4-pin (tape and reel packaging of type II)			LTV-819-2
LTV829-V LTV829M-V LTV829S-V LTV829STA-V LTV829STA1-V	8-pin DIP 8-pin (leads with 0.4" spacing) 8-pin (lead bends for surface mount) 8-pin (tape and reel packaging of type I) 8-pin (tape and reel packaging of type II)			LTV-829
LTV849-V LTV849M-V LTV849S-V LTV849STA-V LTV849STA1-V	16-pin DIP 16-pin (leads with 0.4" spacing) 16-pin (lead bends for surface mount) 16-pin (tape and reel packaging of type I) 16-pin (tape and reel packaging of type II)			LTV-849

Absolute Maximum Ratings

(Ta=25°C)

Parameter		Symbol	Rating	Unit
Input	Forward Current	I _F	50	mA
	Reverse Voltage	V _R	6	V
	Power Dissipation	P	70	mW
Output	Collector-Emitter Voltage	V _{CEO}	35	V
	Emitter-Collector Voltage	V _{ECO}	6	V
	Collector Current	I _C	50	mA
	Collector Power Dissipation	P _C	150	mW
Total Power Dissipation		P _{tot}	170	mW
*1.Isolation Voltage		V _{iso}	5,000	V _{rms}
Operating Temperature		T _{opr}	-25~+100	°C
Storage Temperature		T _{stg}	-40~+125	°C
*2.Soldering Temperature		T _{sol}	260	°C

*1. AC for 1 minute, R.H. = 40 ~ 60%

• Isolation voltage shall be measured using the following method.

(1)Short between anode and cathode on the primary side and between collector, emitter and base on the secondary side.

(2)The isolation voltage tester with zero-cross circuit shall be used.

(3)The waveform of applied voltage shall be a sine wave.

*2. For 10 seconds.

Electrical/Optical Characteristics

(Ta=25°C)

Parameter		Symbol	Min.	Typ.	Max.	Unit	Conditions
Input	Forward Voltage	V _F	—	1.2	1.4	V	I _F =20mA
	Reverse Current	I _R	—	—	10	μA	V _R =4V
	Terminal Capacitance	C _t	—	30	250	pF	V=0, f=1KHz
Output	Collector Dark Current	I _{CEO}	—	—	100	nA	V _{CE} =20V
	Collector-Emitter Breakdown Voltage	BV _{CEO}	35	—	—	V	I _C =0.1mA
	Emitter-Collector Breakdown Voltage	BV _{ECO}	6	—	—	V	I _E =10 μA
Transfer Characteristics	Collector Current	I _C	2.5	—	20	mA	I _F =5mA, V _{CE} =5V
	*Current Transfer Ratio	CTR	50	—	400	%	
	Collector-emitter Saturation Voltage	V _{CE(sat)}	—	0.1	0.2	V	I _F =20mA, I _C =1mA
	Isolation Resistance	R _{iso}	5 × 10 ¹⁰	10 ¹¹	—	Ω	DC500V, 40~60% R.H.
	Floating Capacitance	C _f	—	0.6	1	pF	V=0, f=1MHz
	Cut-off Frequency	f _c	—	80	—	KHz	V _{CE} =5V, I _C =2mA R _L =100 Ω, -3dB
	Response Time (Rise)	t _r	—	4	—	μs	V _{CE} =2V, I _C =2mA
	Response Time (Fall)	t _f	—	3	—	μs	R _L =100 Ω

*CTR= $\frac{I_C}{I_F} \times 100\%$

Typical Electrical/Optical Characteristic Curves (25°C Ambient Temperature Unless Otherwise Noted)

Fig.1 Forward Current vs. Ambient Temperature

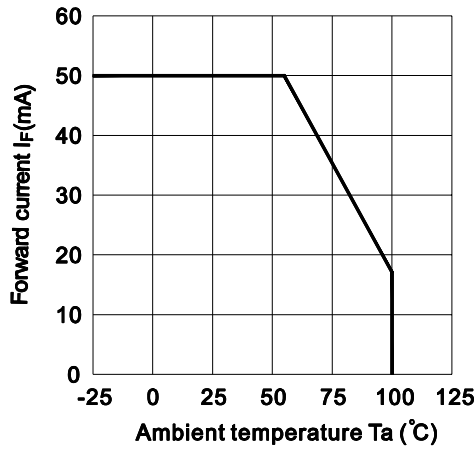

Fig.2 Collector Power Dissipation vs. Ambient Temperature

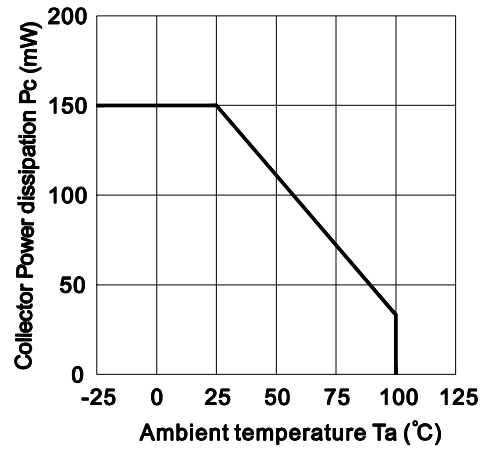

Fig.3 Collector-emitter Saturation Voltage vs. Forward Current

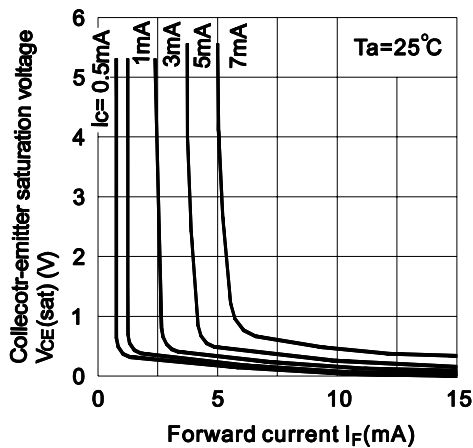

Fig.4 Forward Current vs. Forward Voltage

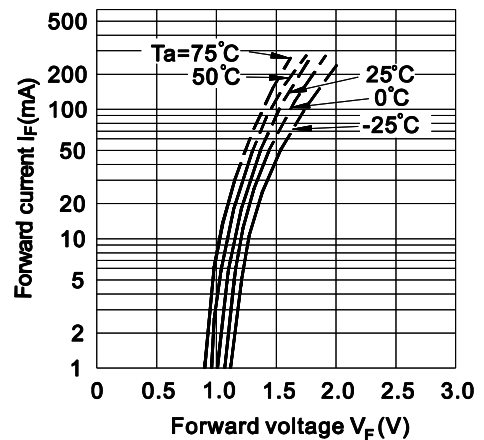

Fig.5 Current Transfer Ratio vs. Forward Current

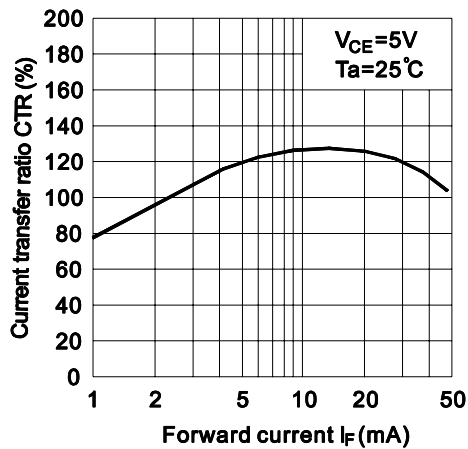

Fig.6 Collector Current vs. Collector-emitter Voltage

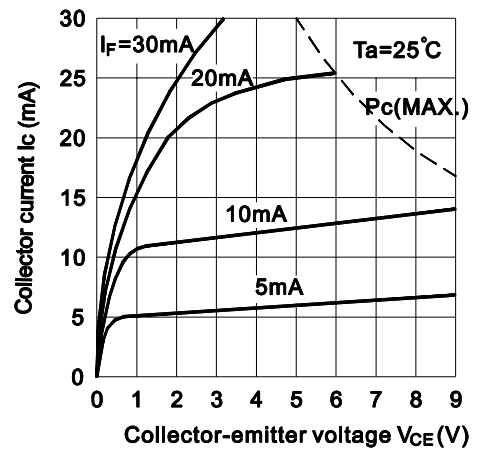

Fig.7 Relative Current Transfer Ratio vs. Ambient Temperature

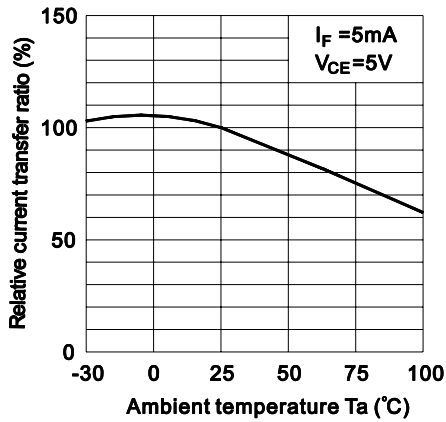

Fig.8 Collector-emitter Saturation Voltage vs. Ambient Temperature

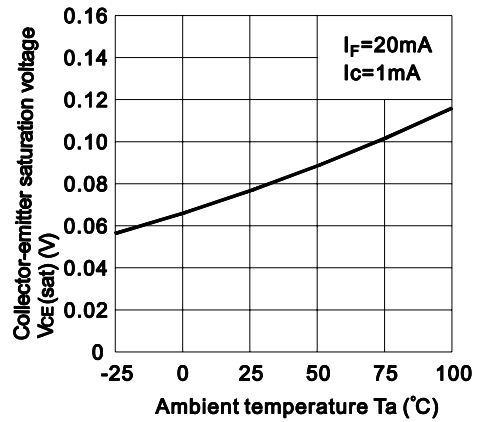

Fig.9 Collector Dark Current vs. Ambient Temperature

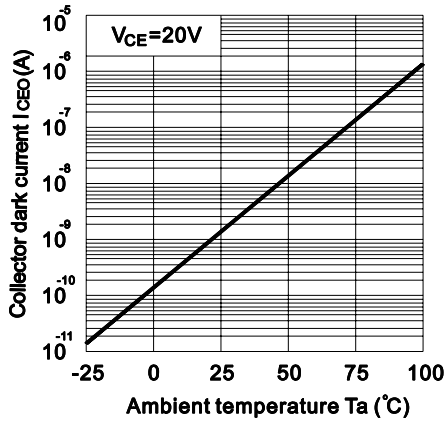

Fig.10 Response Time vs. Load Resistance

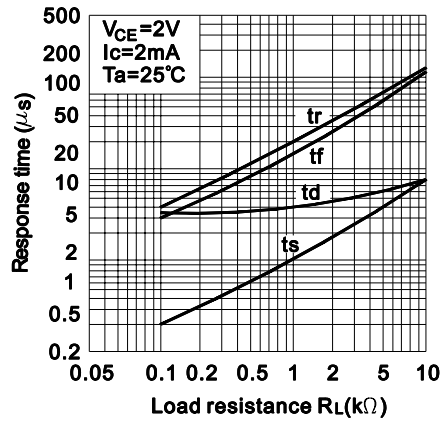
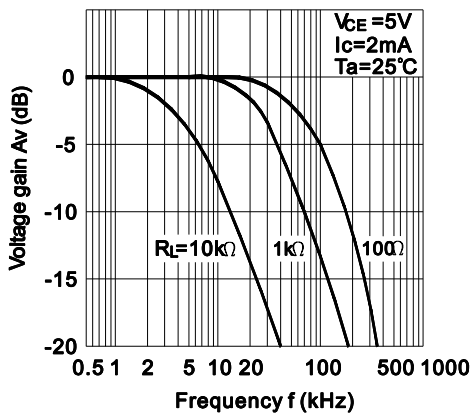
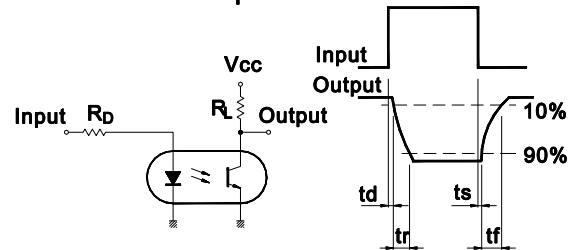

Fig.11 Frequency Response



Test Circuit for Response Time



Test Circuit for Frequency Response

