



# General Purpose Type Photocoupler

LTV-4N25 Series/LTV-4N26 Series

LTV-4N27 Series/LTV-4N28 Series

4N25 Series/4N26 Series/4N27 Series/4N28 Series

## Features

- Response Time  
(tr : TYP, 3  $\mu$  s at  $V_{CE}=10V$ ,  $I_C=2mA$ ,  $R_L=100 \Omega$ )
- UL approved (No. E113898)
- TUV approved (No. R9653630)
- CSA approved (No. CA91533-1)
- FIMKO approved (No. 193422)
- NEMKO approved (No. P96103013)
- DEMKO approved (No. 303985)
- SEMKO approved (No. 9646047/01-30)
- VDE approved (No. 094722)
- Options available :
  - Leads with 0.4"(10.16mm)spacing (M Type)
  - Leads bends for surface mounting(S Type)
  - Tape and Reel of Type I for SMD(Add"-TA"Suffix)
  - Tape and Reel of Type II for SMD(Add"-TA1"Suffix)
  - VDE 0884 approvals (Add"-V"Suffix)

## Package Dimensions

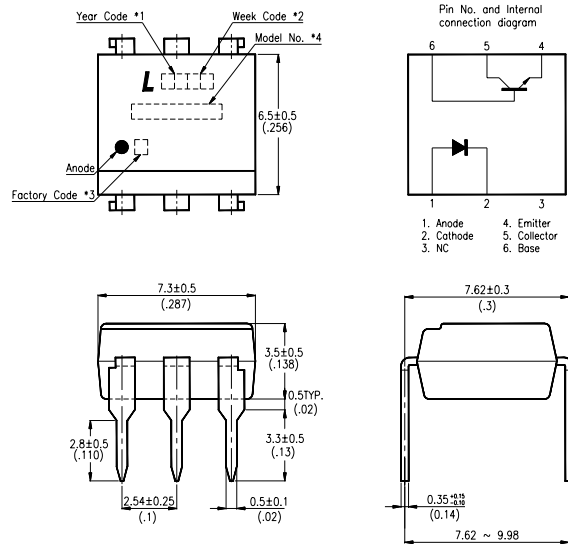

## Applications

1. I/O interfaces for computers.
2. System appliances, measuring instruments.
3. Signal transmission between circuits of different potentials and impedances.

### Note:

1. Year date code.
2. 2-digit work week.
3. Factory code shall be marked (Z : Taiwan, Y : Thailand).
4. Model No. : LTV4N25 ; LTV4N26 ; LTV4N27 ; LTV4N28 ; 4N25 ; 4N26 ; 4N27 ; 4N28.
5. All dimensions are in millimeters (inches).
6. Tolerance is  $\pm 0.25mm$  (.010") unless otherwise noted.
7. Specifications are subject to change without notice.

## Ordering Information

| Part Number  | Package   | Safety Standard Approval  | Application part number  |            |
|--|---|---|--|------------|
| LTV-4N25 / 4N25<br>LTV-4N25M / 4N25M<br>LTV-4N25S / 4N25S<br>LTV-4N25S-TA / 4N25S-TA<br>LTV-4N25S-TA1 / 4N25S-TA1            | 6-pin DIP<br>6-pin (leads with 0.4" spacing)<br>6-pin (lead bends for surface mount)<br>6-pin (tape and reel packaging of type I)<br>6-pin (tape and reel packaging of type II) | <ul style="list-style-type: none"> <li>• UL approved</li> <li>• TUV approved</li> <li>• CSA approved</li> <li>• FIMKO approved</li> <li>• NEMKO approved</li> <li>• SEMKO approved</li> <li>• DEMKO approved</li> </ul> | LTV - 4N25   |            |
| LTV-4N26 / 4N26<br>LTV-4N26M / 4N26M<br>LTV-4N26S / 4N26S<br>LTV-4N26S-TA / 4N26S-TA<br>LTV-4N26S-TA1 / 4N26S-TA1            | 6-pin DIP<br>6-pin (leads with 0.4" spacing)<br>6-pin (lead bends for surface mount)<br>6-pin (tape and reel packaging of type I)<br>6-pin (tape and reel packaging of type II) |   | LTV - 4N26   |            |
| LTV-4N27 / 4N27<br>LTV-4N27M / 4N27M<br>LTV-4N27S / 4N27S<br>LTV-4N27S-TA / 4N27S-TA<br>LTV-4N27S-TA1 / 4N27S-TA1            | 6-pin DIP<br>6-pin (leads with 0.4" spacing)<br>6-pin (lead bends for surface mount)<br>6-pin (tape and reel packaging of type I)<br>6-pin (tape and reel packaging of type II) |   | LTV - 4N27   |            |
| LTV-4N28 / 4N28<br>LTV-4N28M / 4N28M<br>LTV-4N28S / 4N28S<br>LTV-4N28S-TA / 4N28S-TA<br>LTV-4N28S-TA1 / 4N28S-TA1            | 6-pin DIP<br>6-pin (leads with 0.4" spacing)<br>6-pin (lead bends for surface mount)<br>6-pin (tape and reel packaging of type I)<br>6-pin (tape and reel packaging of type II) |   | LTV - 4N28   |            |
| LTV4N25-V / 4N25-V<br>LTV4N25M-V / 4N25M-V<br>LTV4N25S-V / 4N25S-V<br>LTV4N25STA-V / 4N25STA-V<br>LTV4N25STA1-V / 4N25STA1-V | 6-pin DIP<br>6-pin (leads with 0.4" spacing)<br>6-pin (lead bends for surface mount)<br>6-pin (tape and reel packaging of type I)<br>6-pin (tape and reel packaging of type II) |   | <ul style="list-style-type: none"> <li>• VDE approved</li> </ul> | LTV - 4N25 |
| LTV4N26-V / 4N26-V<br>LTV4N26M-V / 4N26M-V<br>LTV4N26S-V / 4N26S-V<br>LTV4N26STA-V / 4N26STA-V<br>LTV4N26STA1-V / 4N26STA1-V | 6-pin DIP<br>6-pin (leads with 0.4" spacing)<br>6-pin (lead bends for surface mount)<br>6-pin (tape and reel packaging of type I)<br>6-pin (tape and reel packaging of type II) |   |  | LTV - 4N26 |
| LTV4N27-V / 4N27-V<br>LTV4N27M-V / 4N27M-V<br>LTV4N27S-V / 4N27S-V<br>LTV4N27STA-V / 4N27STA-V<br>LTV4N27STA1-V / 4N27STA1-V | 6-pin DIP<br>6-pin (leads with 0.4" spacing)<br>6-pin (lead bends for surface mount)<br>6-pin (tape and reel packaging of type I)<br>6-pin (tape and reel packaging of type II) |   |  | LTV - 4N27 |
| LTV4N28-V / 4N28-V<br>LTV4N28M-V / 4N28M-V<br>LTV4N28S-V / 4N28S-V<br>LTV4N28STA-V / 4N28STA-V<br>LTV4N28STA1-V / 4N28STA1-V | 6-pin DIP<br>6-pin (leads with 0.4" spacing)<br>6-pin (lead bends for surface mount)<br>6-pin (tape and reel packaging of type I)<br>6-pin (tape and reel packaging of type II) |   |  | LTV - 4N28 |

## Absolute Maximum Ratings

(Ta=25°C)

| Parameter                |                             | Symbol           | Rating   | Unit             |
|--------------------------|-----------------------------|------------------|----------|------------------|
| Input                    | Forward Current             | I <sub>F</sub>   | 80       | mA               |
|                          | Reverse Voltage             | V <sub>R</sub>   | 6        | V                |
|                          | Power Dissipation           | P                | 150      | mW               |
| Output                   | Collector-Emitter Voltage   | V <sub>CEO</sub> | 30       | V                |
|                          | Collector-Base Voltage      | V <sub>CBO</sub> | 70       | V                |
|                          | Emitter-Collector Voltage   | V <sub>ECO</sub> | 7        | V                |
|                          | Collector Current           | I <sub>c</sub>   | 100      | mA               |
|                          | Collector Power Dissipation | P <sub>c</sub>   | 150      | mW               |
| Total Power Dissipation  |                             | P <sub>tot</sub> | 250      | mW               |
| *1.Isolation Voltage     | 4N25                        | V <sub>iso</sub> | 2,500    | V <sub>rms</sub> |
|                          | 4N26                        |                  | 1,500    |                  |
|                          | 4N27                        |                  | 1,500    |                  |
|                          | 4N28                        |                  | 500      |                  |
| Operating Temperature    |                             | T <sub>opr</sub> | -55~+100 | °C               |
| Storage Temperature      |                             | T <sub>stg</sub> | -55~+150 | °C               |
| *2.Soldering Temperature |                             | T <sub>sol</sub> | 260      | °C               |

\*1. AC for 1 minute, R.H. = 40 ~ 60%

• Isolation voltage shall be measured using the following method.

(1)Short between anode and cathode on the primary side and between collector, emitter and base on the secondary side.

(2)The isolation voltage tester with zero-cross circuit shall be used.

(3)The waveform of applied voltage shall be a sine wave.

\*2. For 10 seconds.

## Electrical/Optical Characteristics

(Ta=25°C)

| Parameter                        |                                      | Symbol               | Min.                 | Typ.                 | Max. | Unit                                       | Conditions                                   |
|----------------------------------|--------------------------------------|----------------------|----------------------|----------------------|------|--|--|
| Input                            | Forward Voltage                      | V <sub>F</sub>       | —                    | 1.2                  | 1.5  | V  | I <sub>F</sub> =10mA                         |
|                                  | Reverse Current                      | I <sub>R</sub>       | —                    | —                    | 10   | μA   | V <sub>R</sub> =4V                           |
|                                  | Terminal Capacitance                 | C <sub>t</sub>       | —                    | 50                   | —    | pF   | V=0, f=1kHz                                  |
| Output                           | Collector Dark Current               | 4N25/26/27           | —                    | —                    | 50   | nA   | V <sub>CE</sub> =10V                         |
|                                  |                                      | 4N28                 | —                    | —                    | 100  |  |  |
|                                  | Collector-Emitter Breakdown Voltage  | BV <sub>CEO</sub>    | 30                   | —                    | —    | V  | I <sub>c</sub> =0.1mA                        |
|                                  | Emitter-Collector Breakdown Voltage  | BV <sub>ECO</sub>    | 7                    | —                    | —    | V  | I <sub>E</sub> =10 μA                        |
| Collector-Base Breakdown Voltage | BV <sub>CBO</sub>                    | 70                   | —                    | —                    | V    | I <sub>c</sub> =0.1mA                      |  |
| Transfer Characteristics         | Collector Current                    | 4N25/26              | 2                    | —                    | —    | mA   | I <sub>F</sub> =10mA<br>V <sub>CE</sub> =10V |
|                                  |                                      | 4N27/28              | 1                    | —                    | —    |  |  |
|                                  | *1 Current Transfer Ratio            | 4N25/26              | 20                   | —                    | —    | %  | I <sub>F</sub> =10mA<br>V <sub>CE</sub> =10V |
|                                  |                                      | 4N27/28              | 10                   | —                    | —    |  |  |
|                                  | Collector-emitter Saturation Voltage | V <sub>CE(sat)</sub> | —                    | 0.1                  | 0.5  | V  | I <sub>F</sub> =50mA, I <sub>c</sub> =2mA    |
|                                  | Isolation Resistance                 | R <sub>iso</sub>     | 5 × 10 <sup>10</sup> | 1 × 10 <sup>11</sup> | —    | Ω  | DC500V, 40~60% R.H.                          |
|                                  | Floating Capacitance                 | C <sub>f</sub>       | —                    | 1.0                  | —    | pF   | V=0, f=1MHz                                  |
|                                  | Response Time (Rise)                 | t <sub>r</sub>       | —                    | 3                    | —    | μs   | V <sub>CE</sub> =10V, R <sub>BE</sub> = ∞    |
| Response Time (Fall)             | t <sub>f</sub>                       | —                    | 3                    | —                    | μs   | R <sub>L</sub> =100 Ω, I <sub>c</sub> =2mA |  |

\*1. CTR=  $\frac{I_c}{I_F} \times 100\%$

# Typical Electrical/Optical Characteristic Curves (25°C Ambient Temperature Unless Otherwise Noted)

Fig.1 Forward Current vs. Ambient Temperature

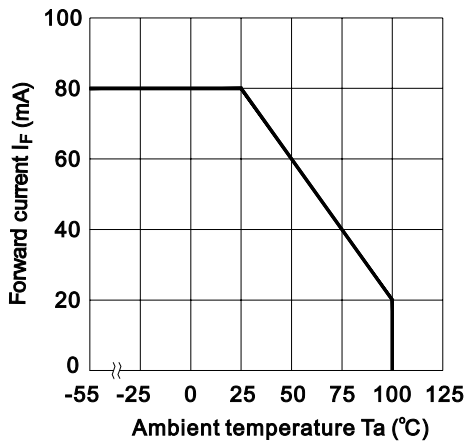

Fig.2 Collector Power Dissipation vs. Ambient Temperature

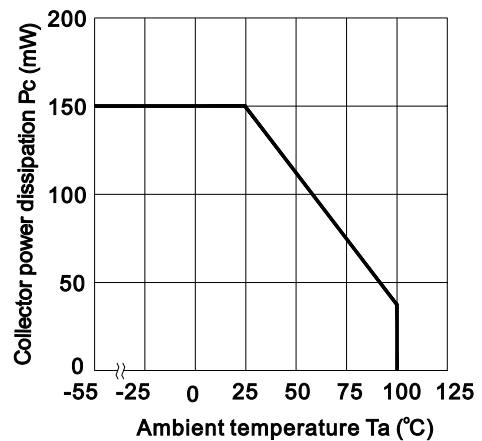

Fig.3 Forward Current vs. Forward Voltage

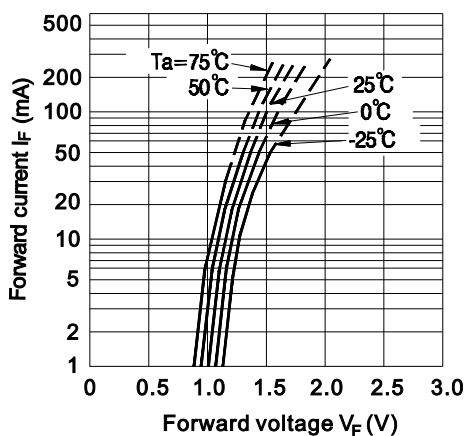

Fig.4 Current Transfer Ratio vs. Forward Current

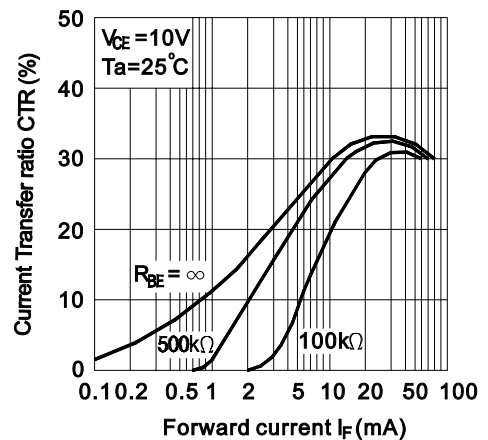

Fig.5 Collector Current vs. Collector-emitter Voltage

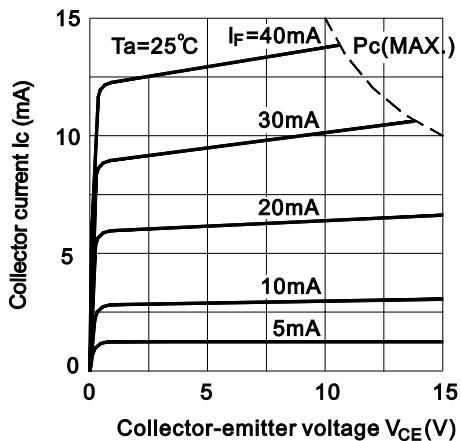
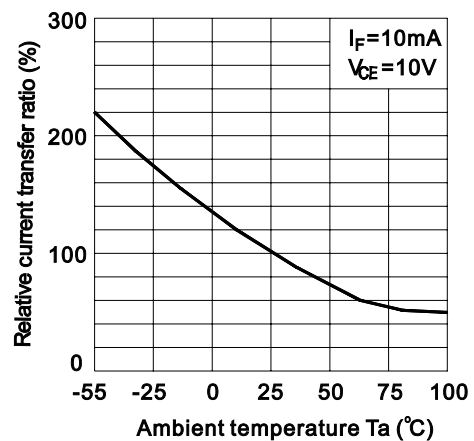

Fig.6 Relative Current Transfer Ratio vs. Ambient Temperature



PHOTOCOUPLER

Fig.7 Collector-emitter Saturation Voltage vs. Ambient Temperature

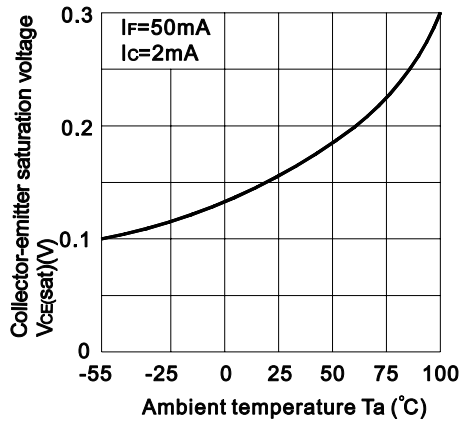

Fig.8 Collector Dark Current vs. Ambient Temperature

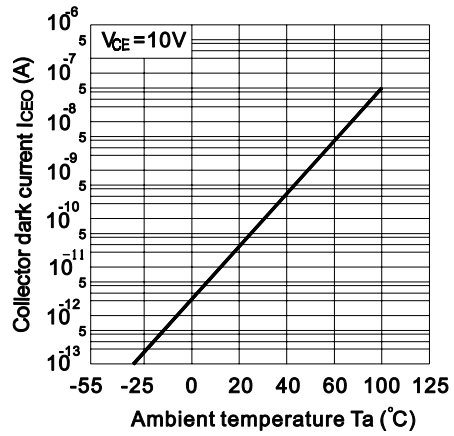

Fig.9 Response Time vs. Load Resistance

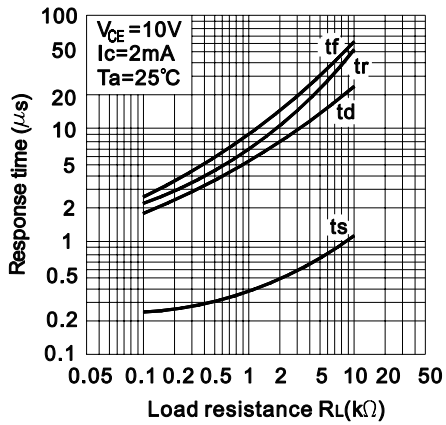

Fig.10 Frequency Response

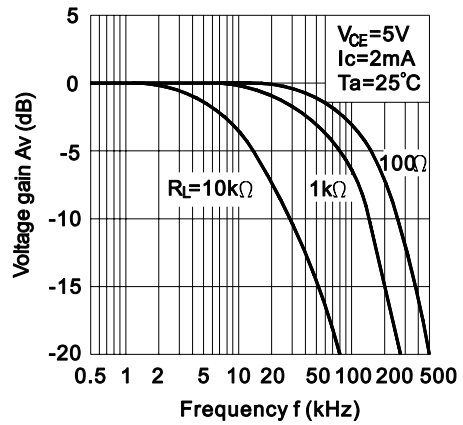
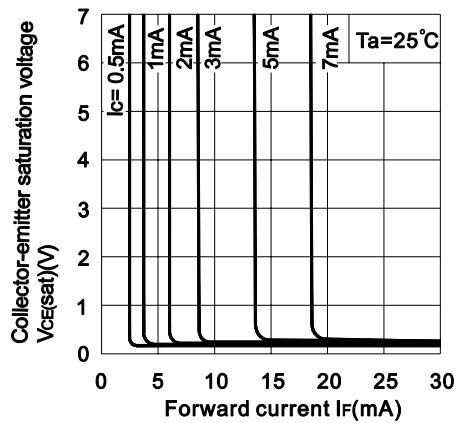
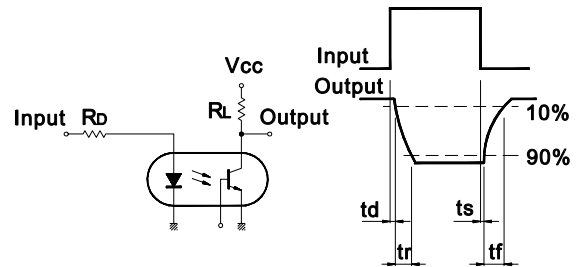

Fig.11 Collector-emitter Saturation Voltage vs. Forward Current



Test Circuit for Response Time



Test Circuit for Frequency Response

