

### FEATURES

1. This specification shall be applied to photocoupler. Model No. LTV-817 as an option.

2. Applicable Models (Business dealing name)

\* Dual-in-line package :

LTV817-V : 1-channel type / LTV827-V : 2-channel type /

LTV847-V : 4-channel type

\* Wide lead spacing package :

LTV817M-V : 1-channel type / LTV827M-V : 2-channel type /

LTV847M-V : 4-channel type

\* Surface mounting package :

LTV817S-V : 1-channel type / LTV827S-V : 2-channel type /

LTV847S-V : 4-channel type

\* Tape and reel packaging :

LTV817STA1-V, LTV827STA1-V

3. The relevant models are the models Approved by VDE according to DIN VDE 0884:1992-06

Approved Model No.: LTV-817 / LTV-827 / LTV-847 / LTV-817M / LTV-827M /  
LTV-847M / LTV-817S / LTV-827S / LTV-847S

VDE approved No.: 094722

(According to the specification DIN VDE 0884:1992-06)

\* Operating isolation voltage  $V_{IORM}$  : 850V (Peak)

\* Transient voltage  $V_{TR}$  : 6000V (Peak)

\* Pollution : 2 (According to VDE 0110-1 : 1997-04)

\* Clearances distance (Between input and output) : 7.0mm (MIN.)

\* Creepage distance (Between input and output) : 7.0mm (MIN.)

\* Isolation thickness between input and output : 0.4mm (MIN.)

\* Safety limit values Current (Isi) : 400mA (Diode side)

Power (Psi) : 700mW (Phototransistor side)

Temperature(Tsi) : 175°C

In order to keep safety electric isolation of photocoupler, please set the protective circuit to keep within safety limit values when the actual application equipment troubled.

\* Indication of VDE 0884 approval prints "4" for 4-pin and "" for 8 & 16 pin on sleeve package.

## OUTLINE DIMENSIONS

### LTV817-V :

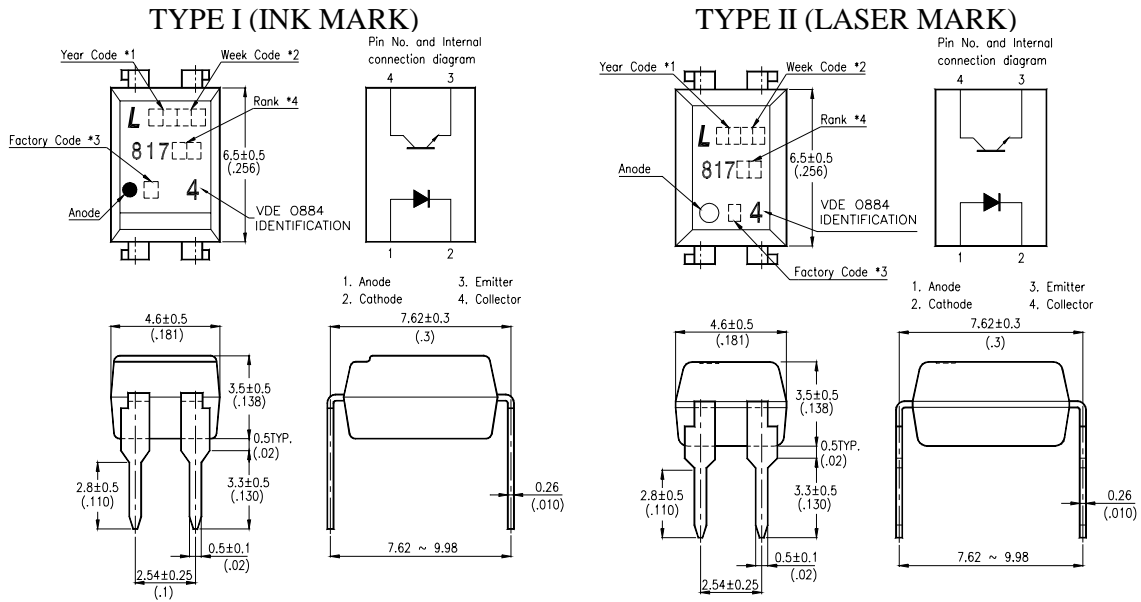

### LTV827-V :

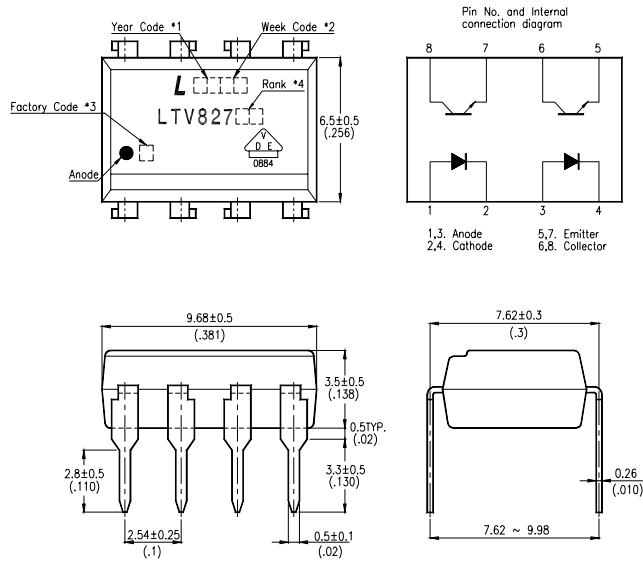

- \*1. Year date code.
- \*2. 2-digit work week.
- \*3. Factory identification mark shall be marked (Z : Taiwan, Y : Thailand, X : China).
- \*4. Rank shall be or shall not be marked.

## OUTLINE DIMENSIONS

### LTV847-V :

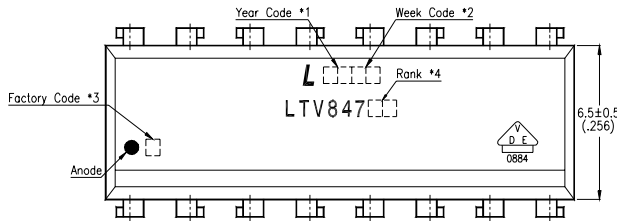

PIN NO. AND INTERNAL CONNECTION DIAGRAM

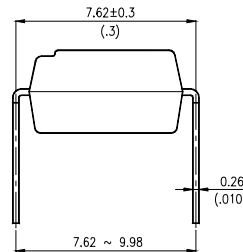
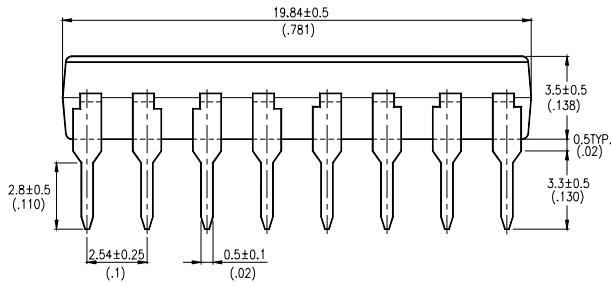
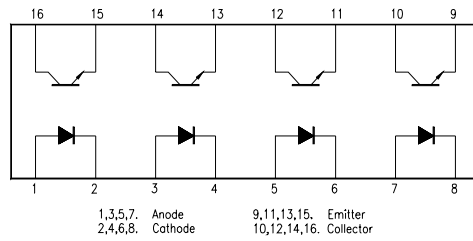

### LTV817M-V :

#### TYPE I (INK MARK)

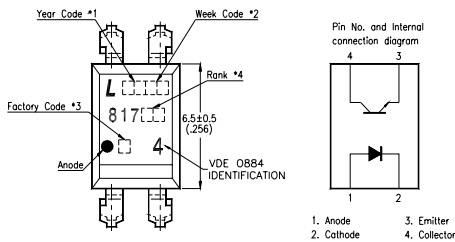

#### TYPE II (LASER MARK)

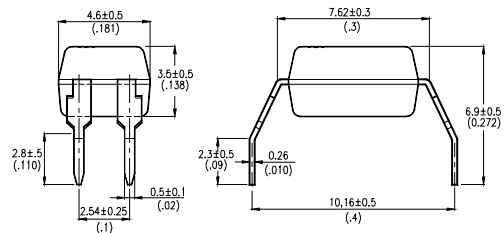
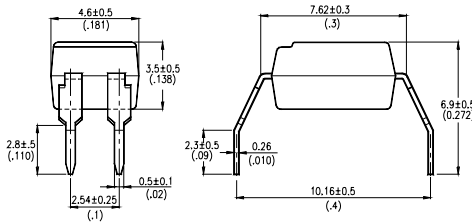
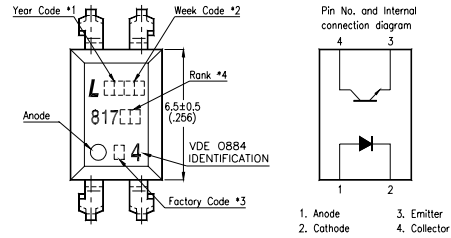

- \*1. Year date code.
- \*2. 2-digit work week.
- \*3. Factory identification mark shall be marked (Z : Taiwan, Y : Thailand, X : China).
- \*4. Rank shall be or shall not be marked.

## OUTLINE DIMENSIONS

### LTV827M-V :

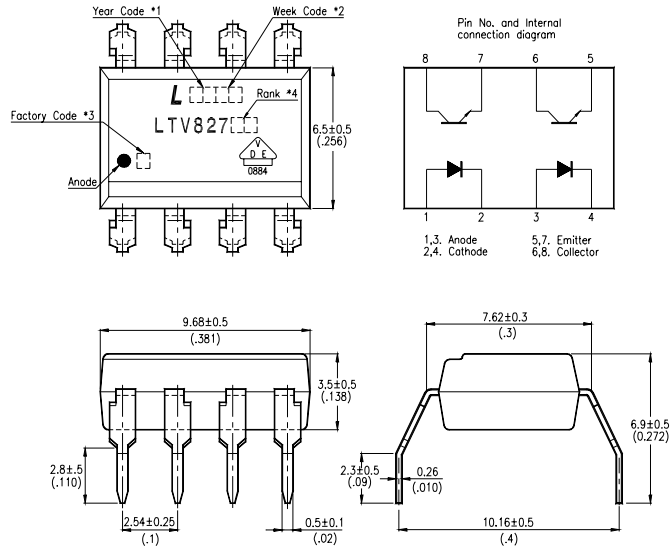

### LTV847M-V :

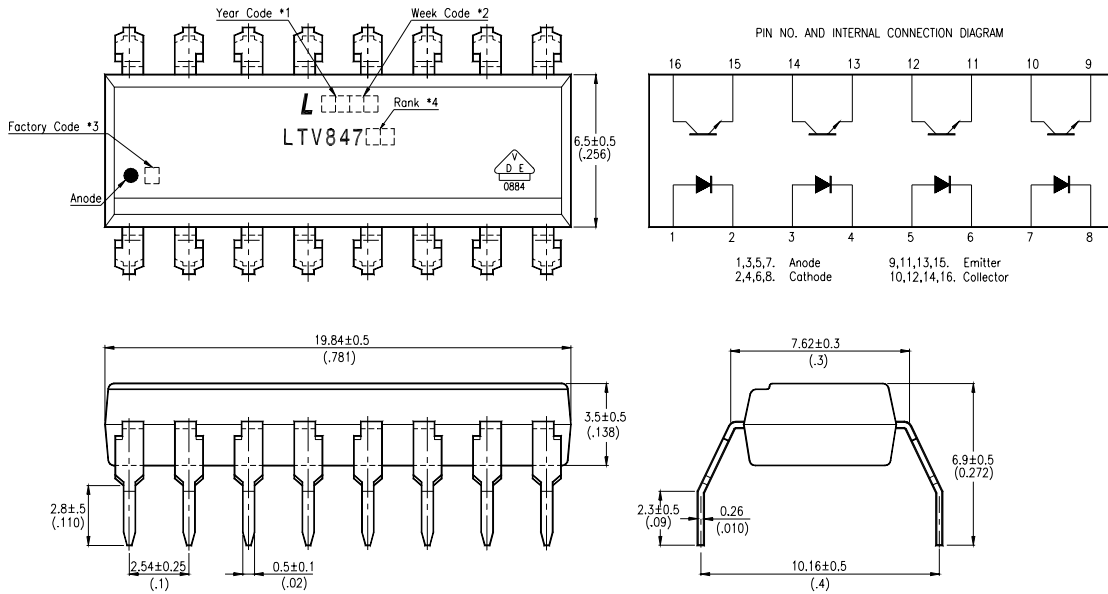

- \*1. Year date code.
- \*2. 2-digit work week.
- \*3. Factory identification mark shall be marked (Z : Taiwan, Y : Thailand, X : China).
- \*4. Rank shall be or shall not be marked.

## OUTLINE DIMENSIONS

### LTV817S-V :

#### TYPE I (INK MARK)

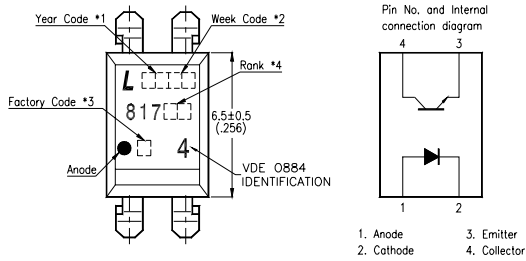

#### TYPE II (LASER MARK)

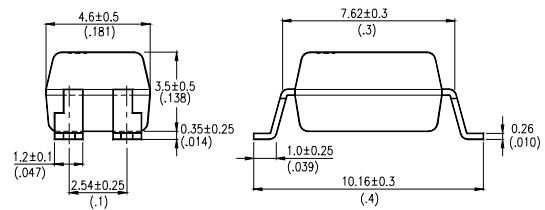
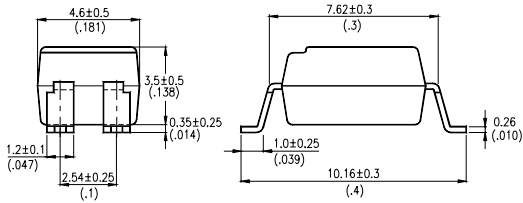
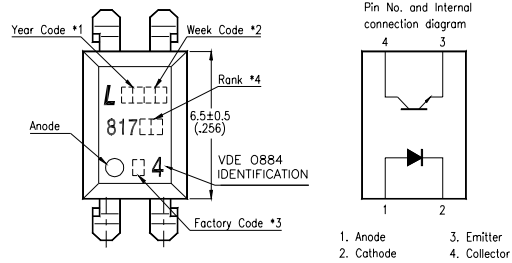

### LTV827S-V :

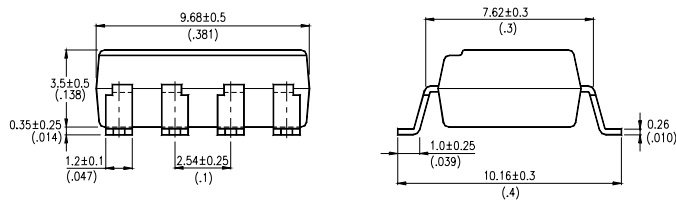
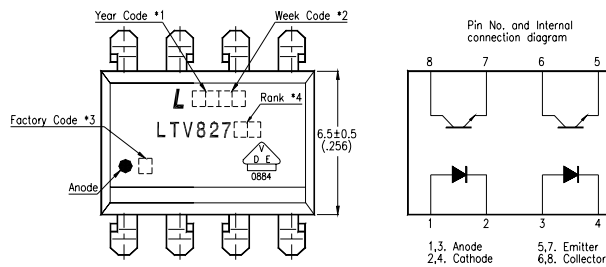

- \*1. Year date code.
- \*2. 2-digit work week.
- \*3. Factory identification mark shall be marked (Z : Taiwan, Y : Thailand, X : China).
- \*4. Rank shall be or shall not be marked.

## OUTLINE DIMENSIONS

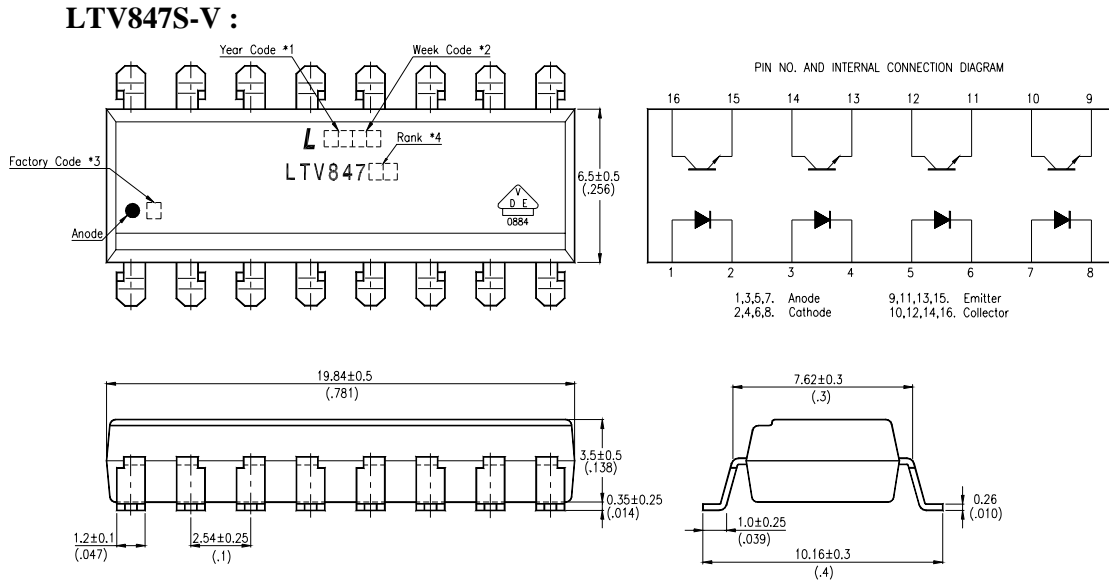

- \*1. Year date code.
- \*2. 2-digit work week.
- \*3. Factory identification mark shall be marked (Z : Taiwan, Y : Thailand, X : China).
- \*4. Rank shall be or shall not be marked.

## TAPING DIMENSIONS

### LTV817STA1-V :

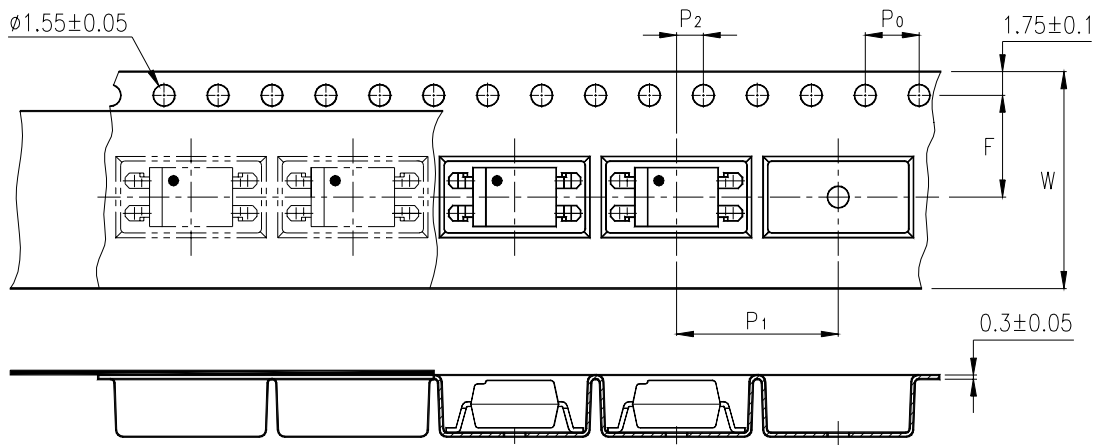

### LTV827STA1-V :

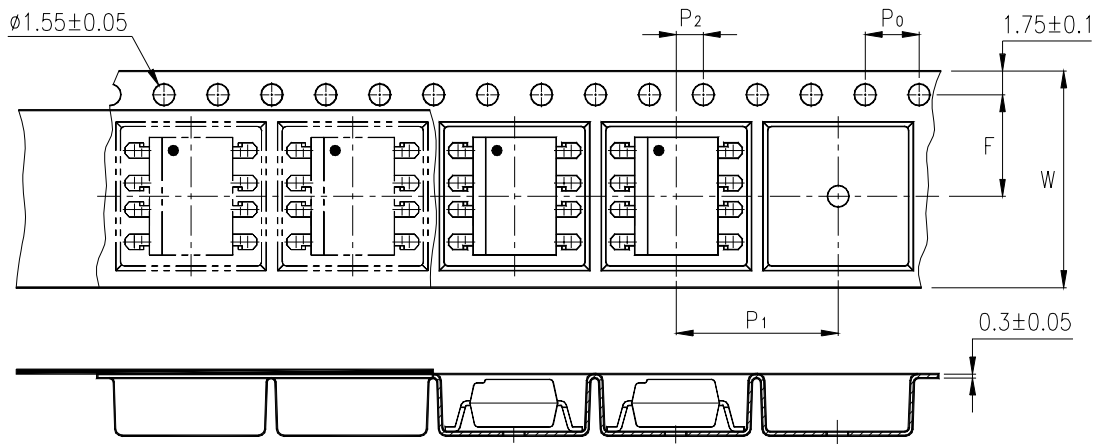

Description	Symbol	Dimensions in mm ( inches )
Tape wide	W	$16 \pm 0.3$ ( .63 )
Pitch of sprocket holes	$P_0$	$4 \pm 0.1$ ( .15 )
Distance of compartment	F	$7.5 \pm 0.1$ ( .295 )
	$P_2$	$2 \pm 0.1$ ( .079 )
Distance of compartment to compartment	$P_1$	$12 \pm 0.1$ ( .472 )

**ABSOLUTE MAXIMUM RATING**

(Ta = 25°C)

PARAMETER		SYMBOL	RATING	UNIT
INPUT	Forward Current	$I_F$	50	mA
	Reverse Voltage	$V_R$	6	V
	Power Dissipation	P	70	mW
OUTPUT	Collector - Emitter Voltage	$V_{CEO}$	35	V
	Emitter - Collector Voltage	$V_{ECO}$	6	V
	Collector Current	$I_C$	50	mA
	Collector Power Dissipation	$P_C$	150	mW
Total Power Dissipation		$P_{tot}$	200	mW
*1	Isolation Voltage	$V_{iso}$	5,000	V <sub>rms</sub>
Operating Temperature		$T_{opr}$	-30 ~ +100	°C
Storage Temperature		$T_{stg}$	-55 ~ +125	°C
*2	Soldering Temperature	$T_{sol}$	260	°C

\*1. AC For 1 Minute, R.H. = 40 ~ 60%

Isolation voltage shall be measured using the following method.

- (1) Short between anode and cathode on the primary side and between collector and emitter on the secondary side.
- (2) The isolation voltage tester with zero-cross circuit shall be used.
- (3) The waveform of applied voltage shall be a sine wave.

\*2. For 10 Seconds



### ELECTRICAL - OPTICAL CHARACTERISTICS

( Ta = 25°C )

PARAMETER		SYMBOL	MIN.	TYP.	MAX.	UNIT	CONDITIONS
INPUT	Forward Voltage	$V_F$	—	1.2	1.4	V	$I_F=20\text{mA}$
	Reverse Current	$I_R$	—	—	10	$\mu\text{A}$	$V_R=4\text{V}$
	Terminal Capacitance	$C_t$	—	30	250	pF	$V=0, f=1\text{KHz}$
OUTPUT	Collector Dark Current	$I_{CEO}$	—	—	100	nA	$V_{CE}=20\text{V}, I_F=0$
	Collector-Emitter Breakdown Voltage	$BV_{CEO}$	35	—	—	V	$I_C=0.1\text{mA}$ $I_F=0$
	Emitter-Collector Breakdown Voltage	$BV_{ECO}$	6	—	—	V	$I_E=10\mu\text{A}$ $I_F=0$
TRANSFER CHARACTERISTICS	Collector Current	$I_C$	2.5	—	30	mA	$I_F=5\text{mA}$ $V_{CE}=5\text{V}$
	* Current Transfer Ratio	CTR	50	—	600	%	
	Collector-Emitter Saturation Voltage	$V_{CE}(\text{sat})$	—	0.1	0.2	V	$I_F=20\text{mA}$ $I_C=1\text{mA}$
	Isolation Resistance	Riso	$5 \times 10^{10}$	$1 \times 10^{11}$	—	$\Omega$	DC500V 40 ~ 60% R.H.
	Floating Capacitance	$C_f$	—	0.6	1	pF	$V=0, f=1\text{MHz}$
	Cut-Off Frequency	fc	—	80	—	kHz	$V_{CE}=5\text{V}, I_C=2\text{mA}$ $R_L=100\Omega, -3\text{dB}$
	Response Time (Rise)	$t_r$	—	4	18	$\mu\text{s}$	$V_{CE}=2\text{V}, I_C=2\text{mA}$ $R_L=100\Omega$
	Response Time (Fall)	$t_f$	—	3	18	$\mu\text{s}$	

$$* \text{ CTR} = \frac{I_C}{I_F} \times 100\%$$

**RANK TABLE OF CURRENT TRANSFER RATIO CTR**

MODEL NO.	RANK MARK	CTR ( % )
LTV817-V	L	50 ~ 100
	A	80 ~ 160
	B	130 ~ 260
	C	200 ~ 400
	D	300 ~ 600
	L or A or B or C or D or No mark	50 ~ 600
LTV827-V LTV847-V	B	130 ~ 260
	B or C or BC	130 ~ 400
	C	200 ~ 400
	C or D or CD	200 ~ 600
	B、 BC、 C、 CD or No mark	50 ~ 600

<b>CONDITIONS</b>	$I_F = 5 \text{ mA}$ $V_{CE} = 5 \text{ V}$ $T_a = 25 \text{ }^\circ\text{C}$
-------------------	---

## ISOLATION SPECIFICATION ACCORDING TO VDE 0884

Parameter	Symbol	Conditions	Rating	Unit	Remark
Class of environmental test	-	DIN IEC68	30/100/21	-	
Pollution	-	DIN VDE0110	2	-	
Maximum Operating Isolation Voltage	$V_{IORM}$	-	850	$V_{PEAK}$	Refer to the Diagram 1, 2
Partial Discharge Test Voltage (Between Input and Output)	Diagram 1	$V_{pr}$	$t_p=60s, q_c<5pC$	$V_{PEAK}$	
	Diagram 2		$t_p=1s, q_c<5pC$	$V_{PEAK}$	
Maximum Over-voltage	$V_{INITIAL}$	$t_{INI} = 10s$	6000	$V_{PEAK}$	
Safety Maximum Ratings					
1) Case Temperature	$T_{si}$	$I_F = 0, P_c = 0$	175	$^{\circ}C$	Refer to the Figure 1, 3
2) Input Current	$I_{si}$	$P_c=0$	400	mA	
3) Electric Power (Output or Total Power Issipation)	$P_{si}$	-	700	mW	
Isolation Resistance (Test Voltage Between Input and Output : DC500V)	$R_{ISO}$	$T_a=T_{si}$	MIN.10 <sup>9</sup>	$\Omega$	
		$T_a=T_{opr}(MAX.)$	MIN.10 <sup>11</sup>		
		$T_a=25^{\circ}C$	MIN.10 <sup>12</sup>		

### Precautions in performing isolation test

\* Partial discharge test methods shall be the ones according to the specifications of VDE 0884:1992-06

\* Please don't carry out isolation test ( $V_{iso}$ ) over  $V_{INITIAL}$ , This product deteriorates isolation characteristics by partial discharge due to applying high voltage (ex.  $V_{INITIAL}$ ). And there is possibility that this product occurs partial discharge in operating isolation voltage ( $V_{IORM}$ )

## PARTIAL DISCHARGE TEST METHOD

Method (A) for type testing and random testing.

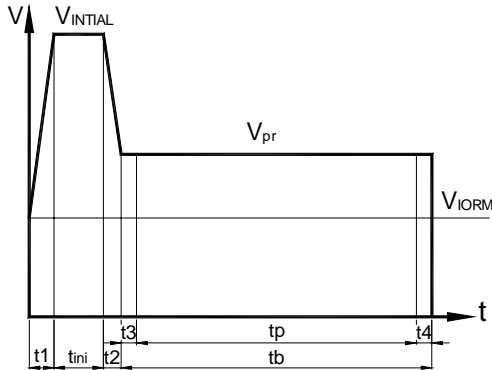

$t_1, t_2$  = 1 to 10s  
 $t_3, t_4$  = 1s  
 $t_p$  (Partial Discharge Measuring Time) = 60s  
 $t_b$  = 62s  
 $t_{ini}$  = 10s

Method (B) for routine testing.

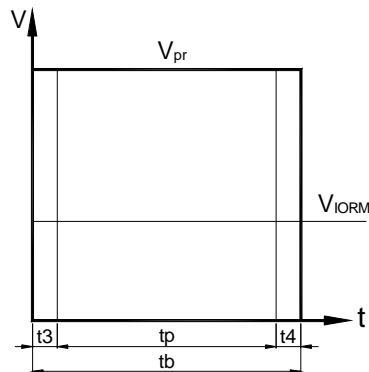

$t_3, t_4$  = 0.1s  
 $t_p$  (Partial Discharge Measuring Time) = 1s  
 $t_b$  = 1.2s

The partial discharge level shall not exceed 5 pC during the partial discharge measuring time interval  $t_p$  under the test conditions shown above.

## CHARACTERISTICS CURVES

Fig.1 Forward Current vs. Ambient Temperature

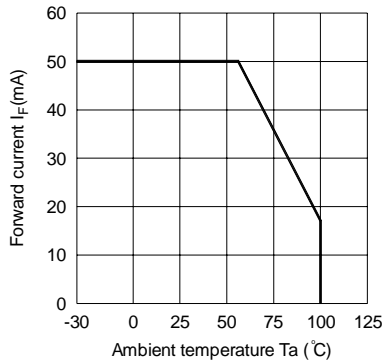

Fig.2 Collector Power Dissipation vs. Ambient Temperature

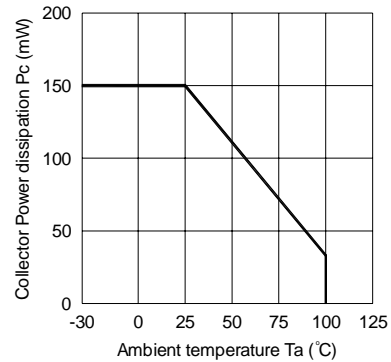

Fig.3 Collector-emitter Saturation Voltage vs. Forward Current

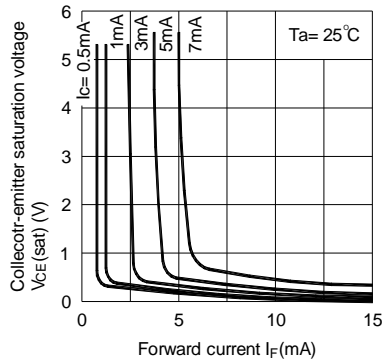

Fig.4 Forward Current vs. Forward Voltage

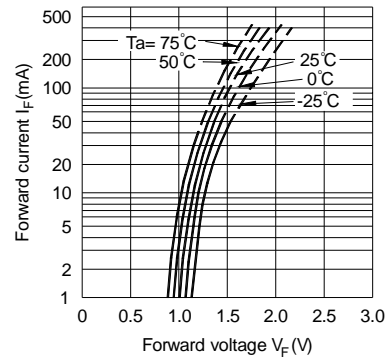

Fig.5 Current Transfer Ratio vs. Forward Current

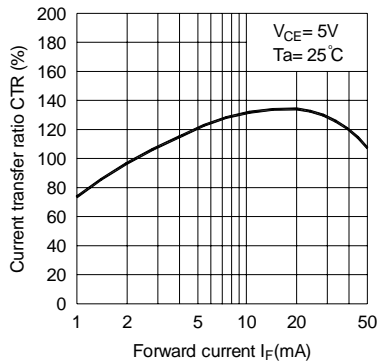
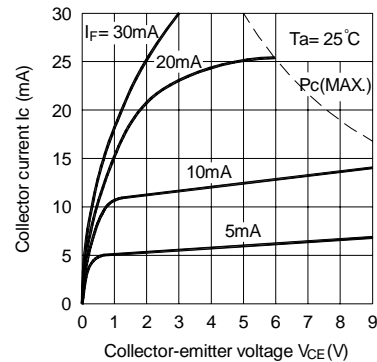

Fig.6 Collector Current vs. Collector-emitter Voltage



## CHARACTERISTICS CURVES

Fig.7 Relative Current Transfer Ratio vs. Ambient Temperature

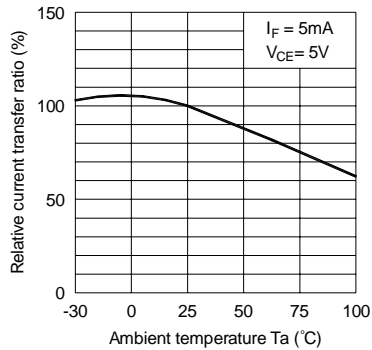

Fig.8 Collector-emitter Saturation Voltage vs. Ambient Temperature

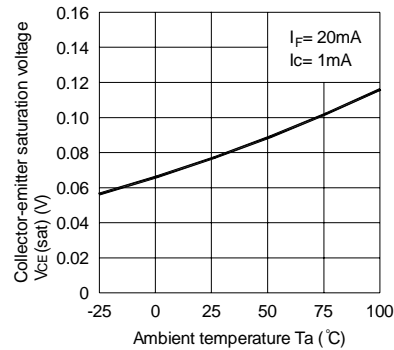

Fig.9 Collector Dark Current vs. Ambient Temperature

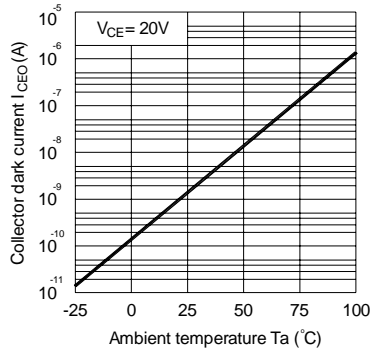

Fig.10 Response Time vs. Load Resistance

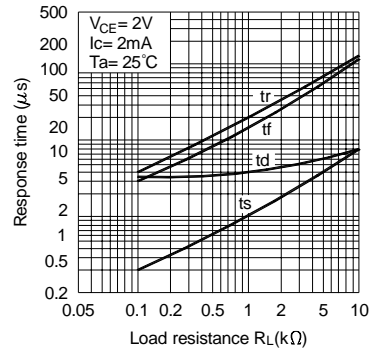
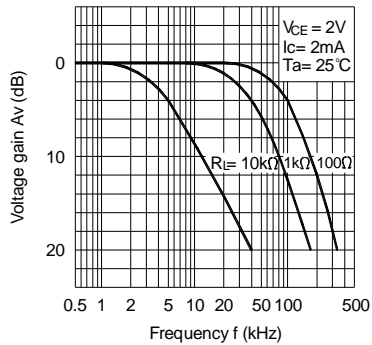
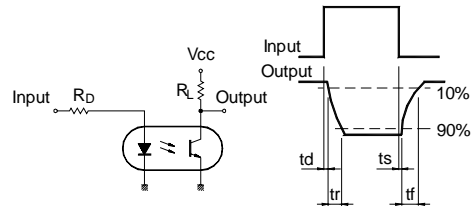

Fig.11 Frequency Response



Test Circuit for Response Time



Test Circuit for Frequency Response

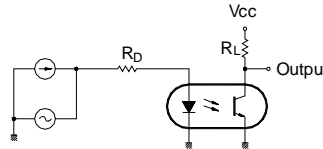

## RECOMMENDED FOOT PRINT PATTERNS (MOUNT PAD)

Unit : mm

4 PIN

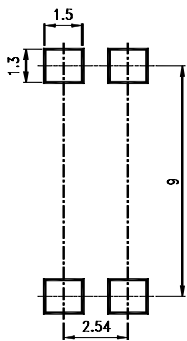

8 PIN

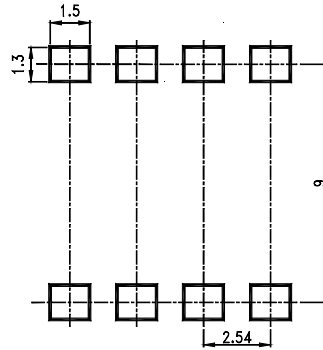

16 PIN

