

4

3

2

1

THIS DRAWING IS UNPUBLISHED. RELEASED FOR PUBLICATION  
 © COPYRIGHT BY TYCO ELECTRONICS CORPORATION. ALL RIGHTS RESERVED.

LOC	DIST	REVISIONS				
P	LTR	DESCRIPTION	DATE	DWN	APVD	
	A	REDRAW AND REVISED (ECR-09-001487)	11JAN09	SC	WK	
	A1	REVISED PER ECO-09-024927	21JAN10	KK	HMR	

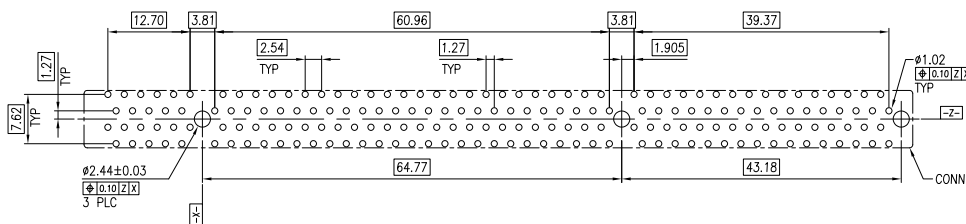
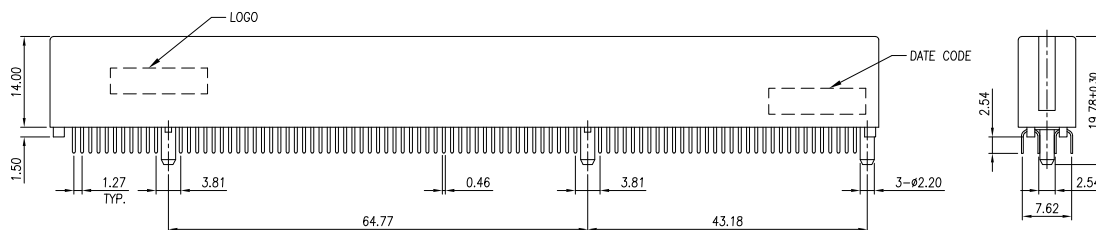
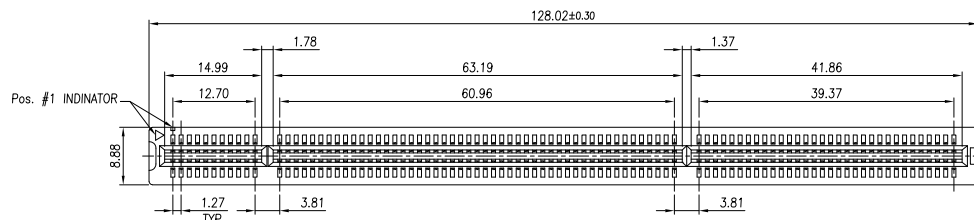

NOTES:  
 1. MATERIAL:  
 HOUSING: PA46 ,UL 94V-0, COLOR: SEE TABLE.  
 CONTACTS: PHOSPHOR BRONZE.

2. FINISH:  
 CONTACTS:  
 SELECTIVE GOLD (SEE TABLE) PLATED ON CONTACT AREA,  
 2.54µm [100µ"] MIN. MATTE-TIN PLATING ON SOLDER TAIL,  
 1.27µm [50µ"] MIN. NICKEL UNDERPLATED OVERALL.  
 3. WAVE SOLDER CAPABLE TO 265°C PER TE TEST SPEC.  
 109-202, CONDITION B.

⚠ OBSOLETE PARTS: OBSOLETE CIS STREAMLINING PER D.RENAUD/D.SINISI

RECOMMENDED PCB LAYOUT (TOP VIEW)  
 TOLERANCE : ±0.05

VOLTAGE	HOUSING COLOR	GOLD PLATING	PART NUMBER
3.3V	LIGHT GREEN (365C)	15µ"	6-1734377-2
		6/F	6-1734377-1
	ORANGE (1575C)	15µ"	4-1734377-2
		6/F	4-1734377-1
	GREEN (347C)	15µ"	2-1734377-2
		6/F	2-1734377-1
WHITE	30µ"	1734377-3	
	15µ"	1734377-2	
	6/F	1734377-1	

THIS DRAWING IS A CONTROLLED DOCUMENT.

DIMENSIONS: MM	TOLERANCES UNLESS OTHERWISE SPECIFIED:	DWN S. CHIEN 12JAN2009	Tyco Electronics Corporation Taipei, Taiwan
	0 PLC ± -	CHK S. CHIEN 12JAN2009	
	1 PLC ± 0.30	APVD W. KODAMA 12JAN2009	
	2 PLC ± 0.20	NAME	
	3 PLC ± -	PRODUCT SPEC	108-57384
	4 PLC ± -	QUALIFICATION TEST REPORT	501-57440
	ANGLES ± -	WEIGHT	
MATERIAL SEE NOTE	FINISH SEE NOTE	SIZE A3	CAGE CODE 00779
		DRAWING NO	C=1734377
		CUSTOMER DRAWING	RESTRICTED TO -
		SCALE -	SHEET 1 OF 4
			REV A1

4

3

2

1

THIS DRAWING IS UNPUBLISHED. RELEASED FOR PUBLICATION  
 © COPYRIGHT BY TYCO ELECTRONICS CORPORATION. ALL RIGHTS RESERVED.

LOC	DIST	REVISIONS					
DW	-	P	LTR	DESCRIPTION	DATE	DWN	APVD
		SEE SHEET 1					

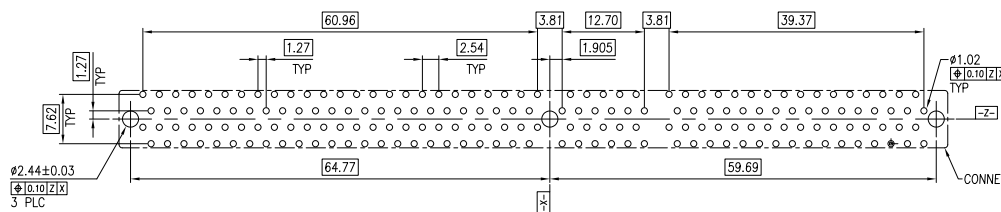
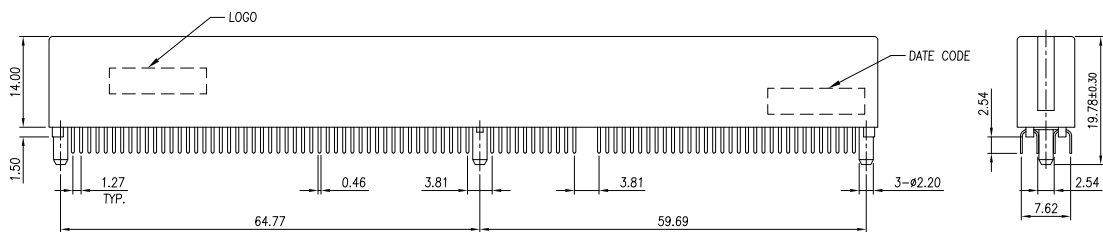
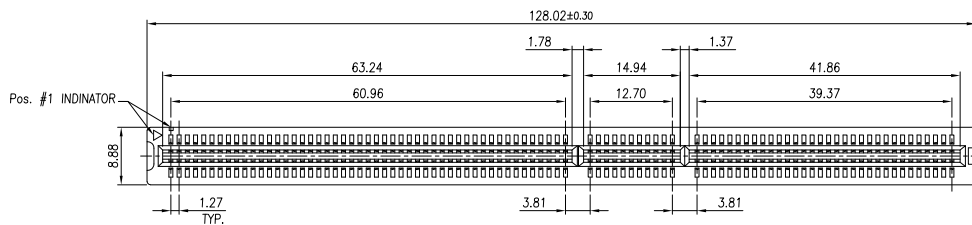

OBSOLETE	5.0V	LIGHT GREEN (365C)	15u"	7-1734377-2
			G/F	7-1734377-1
		ORANGE (1575C)	15u"	5-1734377-2
			G/F	5-1734377-1
OBSOLETE	5.0V	GREEN (347C)	15u"	3-1734377-2
			G/F	3-1734377-1
			30u"	1-1734377-3
OBSOLETE	5.0V	WHITE	15u"	1-1734377-2
			G/F	1-1734377-1
	VOLTAGE	HOUSING COLOR	GOLD PLATING	PART NUMBER

- NOTES:
- MATERIAL:  
HOUSING: PA46 ,UL 94V-0, COLOR: SEE TABLE.  
CONTACTS: PHOSPHOR BRONZE.
  - FINISH:  
CONTACTS:  
SELECTIVE GOLD (SEE TABLE) PLATED ON CONTACT AREA,  
2.54um [100u"] MIN. MATTE-TIN PLATING ON SOLDER TAIL,  
1.27um [50u"] MIN. NICKEL UNDERPLATED OVERALL.
  - WAVE SOLDER CAPABLE TO 265°C PER TE TEST SPEC.  
109-202, CONDITION B.

THIS DRAWING IS A CONTROLLED DOCUMENT.

DIMENSIONS: MM	TOLERANCES UNLESS OTHERWISE SPECIFIED:	DWN	CHK	Tyco Electronics Corporation Taipei, Taiwan
	0 PLC ± -	APVD	NAME	
	1 PLC ± 0.30	PRODUCT SPEC	PCI, CARD EDGE 184P, VERTICAL, DIP TYPE	
	2 PLC ± 0.20	QUALIFICATION TEST REPORT	SIZE CAGE CODE DRAWING NO	
MATERIAL SEE NOTE	FINISH SEE NOTE	WEIGHT	RESTRICTED TO	
		A3 00779 C=1734377		
		CUSTOMER DRAWING		SCALE - SHEET 2 of 4 REV A1

4

3

2

1

THIS DRAWING IS UNPUBLISHED. RELEASED FOR PUBLICATION  
 © COPYRIGHT BY TYCO ELECTRONICS CORPORATION. ALL RIGHTS RESERVED.

LOC	DIST	REVISIONS			
P	LTR	DESCRIPTION	DATE	DWN	APVD
DW	-	SEE SHEET 1			

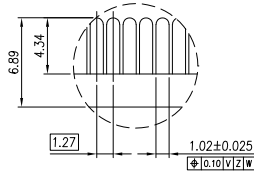

DETAIL B  
SCALE: 2:1

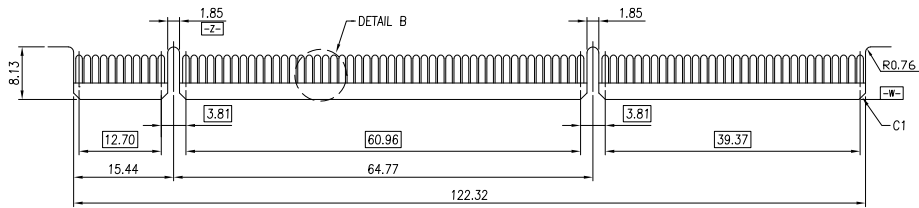

RECOMMENDED MATING COMPONENT BOARD (3.3V)  
Tolerance: ±0.05

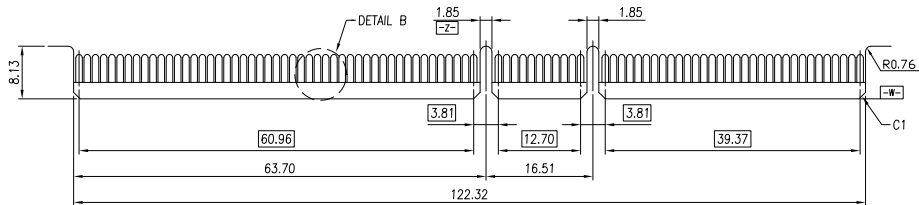

RECOMMENDED MATING COMPONENT BOARD (5.0V)  
Tolerance: ±0.05

THIS DRAWING IS A CONTROLLED DOCUMENT.		DWN	Tyco Electronics Corporation Taipei, Taiwan	
DIMENSIONS:	TOLERANCES UNLESS OTHERWISE SPECIFIED:	CHK	NAME	
MM	0 PLC ± -	APVD	PCI, CARD EDGE 184P, VERTICAL, DIP TYPE	
	1 PLC ± -	PRODUCT SPEC	SIZE	CAGE CODE
	2 PLC ± -	QUALIFICATION TEST REPORT	A3	00779
	3 PLC ± -	WEIGHT	DRAWING NO	
	4 PLC ± -	CUSTOMER DRAWING	C=1734377	
MATERIAL	FINISH	RESTRICTED TO	SCALE	SHEET
		-	-	3 of 4
		REV	A1	

4

3

2

1

THIS DRAWING IS UNPUBLISHED. RELEASED FOR PUBLICATION  
 © COPYRIGHT - BY TYCO ELECTRONICS CORPORATION. ALL RIGHTS RESERVED.

LOC	DIST	REVISIONS				
P	LTR	DESCRIPTION	DATE	DWN	APVD	
DW	-					

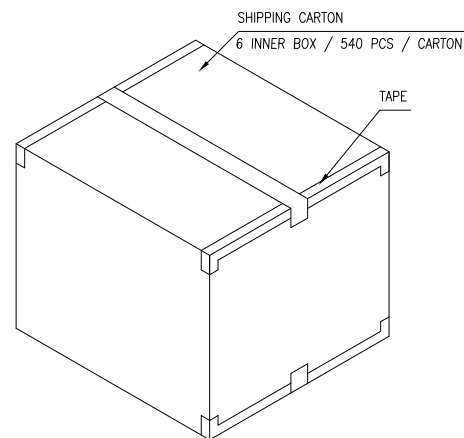
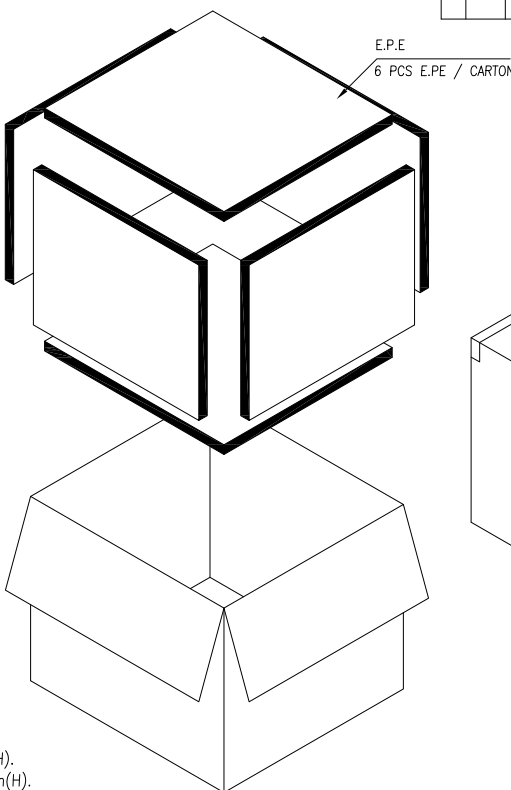
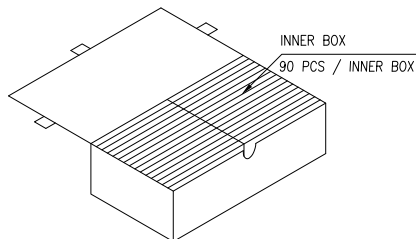
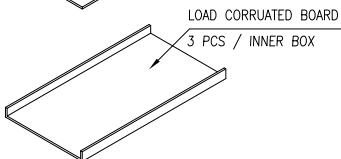
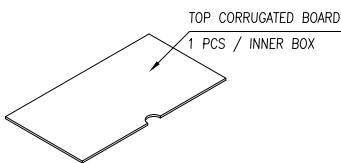

NOTES:

1. TOP CORRUGATED PLATE SIZE: 256mm(L)X 137mm(W)X 3mm(H).
2. LOAD CORRUGATED PLATE SIZE: 256mm(L)X 137mm(W)X 15mm(H).
3. INNER BOX SIZE: 272mm(L)X 147mm(W)X 78mm(H).
4. CARTON SIZE: 345mm(L)X 320mm(W)X 285mm(H).
5. NET WEIGHT: 10.0 Kg.
6. GROSS WEIGHT: 11.8 Kg.

90	6	540 PCS	11.8 KG	10.0 KG
PCS / BOX	BOX / CARTON	QUANTITY	GROSS WEIGHT	NET WEIGHT

THIS DRAWING IS A CONTROLLED DOCUMENT.		DWN	Tyco Electronics Corporation Taipei, Taiwan													
DIMENSIONS: MM		CHK	NAME													
TOLERANCES UNLESS OTHERWISE SPECIFIED:		APVD	PCI, CARD EDGE 184P, VERTICAL, DIP TYPE													
<table border="1"> <tr><td>0 PLC</td><td>±</td></tr> <tr><td>1 PLC</td><td>±</td></tr> <tr><td>2 PLC</td><td>±</td></tr> <tr><td>3 PLC</td><td>±</td></tr> <tr><td>4 PLC</td><td>±</td></tr> <tr><td>ANGLES</td><td>±</td></tr> </table>		0 PLC	±	1 PLC	±	2 PLC	±	3 PLC	±	4 PLC	±	ANGLES	±	PRODUCT SPEC	RESTRICTED TO	
0 PLC	±															
1 PLC	±															
2 PLC	±															
3 PLC	±															
4 PLC	±															
ANGLES	±															
MATERIAL FINISH		QUALIFICATION TEST REPORT	-													
		WEIGHT	SIZE	CAGE CODE												
			A3	00779												
		CUSTOMER DRAWING	DRAWING NO	©=1734377												
		SCALE	SHEET	REV												
		-	4 of 4	A1												