

4

3

2

1

THIS DRAWING IS UNPUBLISHED. RELEASED FOR PUBLICATION. COPYRIGHT 20 BY ALL RIGHTS RESERVED.

- MATERIAL AND FINISH:**
- CONNECTOR SHELL - NICKEL PLATED ALUMINUM
  - QUADRAX RETENTION CLIP - SILVER PLATED STAINLESS STEEL
  - JAM-NUT - NICKEL PLATED ALUMINUM
  - QUADRAX CONNECTOR - GOLD PLATED COPPER ALLOY AND BRASS, AND THERMOPLASTIC
  - FLANGE SEALING O-RING - FLUOROSILICONE RUBBER
  - INTERFACIAL SEAL - FLUOROSILICONE RUBBER

TYCO ELECTRONICS LOGO OR TE

REVISIONS				
P	LY	DESCRIPTION	DATE	BY
A		REV PER ECO 11-004015	3-30-11	CT DM

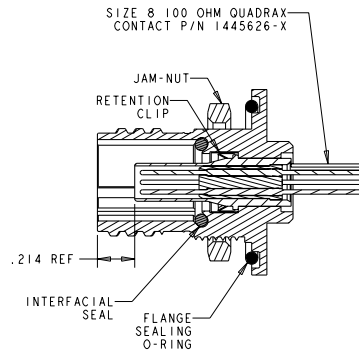
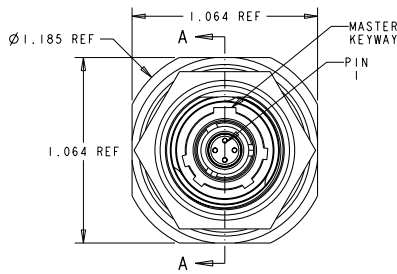
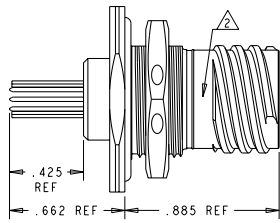
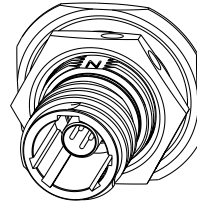

SECTION A-A

SOLDERTAIL LENGTHS APPLY TO QUADRAX CONTACT 1445626-2 ONLY

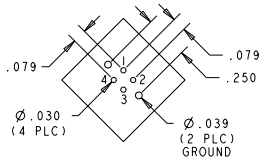

PCB LAYOUT 1738916-1, 2, AND 3

1445626-1	SEE SHEET 2	"B" KEY	1738916-6
1445626-1	SEE SHEET 2	"A" KEY	1738916-5
1445626-1	SEE SHEET 2	"N" KEY	1738916-4
1445626-2	SEE SHEET 1	"B" KEY	1738916-3
1445626-2	SEE SHEET 1	"A" KEY	1738916-2
1445626-2	SEE SHEET 1	"N" KEY	1738916-1
QUADRAX CONTACT	38999	POLARIZATION	PART NUMBER

THIS DRAWING IS A CONTROLLED DOCUMENT. DATE: 22APR2004

DESIGNER: JMS, CHECKED: WHR, APPROVED: JPD, DATE: 22APR2004

TO: CUSTOMER, FROM: TYCO ELECTRONICS

PRODUCT SPEC: - APPLICATION SPEC: -

WEIGHT: - MATERIAL: - FINISH: -

CUSTOMER DRAWING

SCALE: 1:1 SHEET 1 OF 2 REV A

TE Connectivity

RECEPTACLE, 38999 SERIES III, SIZE 9 JAM-NUT STYLE, SINGLE QUADRAX

SHEET CASE CODE: A200779 DRAWING NO: 1738916

RESTRICTED TO: -

THIS DRAWING IS UNPUBLISHED. RELEASED FOR PUBLICATION. ALL RIGHTS RESERVED.

REV	DATE	BY	APPROV
1			
2			
3			
4			

4 3 2 1

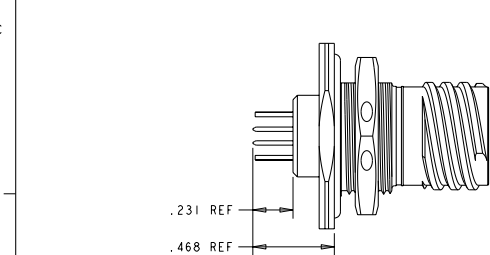

SOLDERTAIL LENGTHS APPLY TO QUADRAX CONTACT J445626-1 ONLY

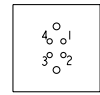
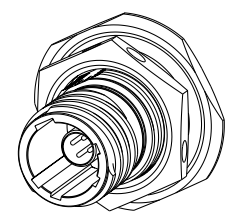
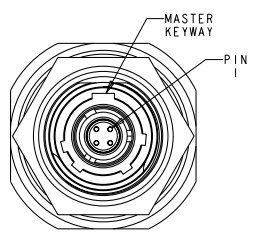

PCB ORIENTATION (SEE SHEET 1 FOR DIMENSIONS)

QUADRAX CONTACT ORIENTATION 1738916-4, 5, AND 6

THIS DRAWING IS A CONTROLLED DOCUMENT.		OWN: 22APR2004	TE Connectivity														
DIMENSIONS: INCHES		DATE: 22APR2004															
TOLERANCES UNLESS OTHERWISE SPECIFIED:		APPROV: 22APR2004	RECEPTACLE, 38999 SERIES IIII, SIZE 9 JAM-NUT STYLE, SINGLE QUADRAX														
<table border="1"> <tr><td>Ø</td><td>PLC</td><td>±0.1</td></tr> <tr><td></td><td>PLC</td><td>±0.01</td></tr> <tr><td></td><td>PLC</td><td>±0.001</td></tr> <tr><td></td><td>PLC</td><td>±0.0001</td></tr> <tr><td></td><td>ANGLES</td><td></td></tr> </table>		Ø		PLC	±0.1		PLC	±0.01		PLC	±0.001		PLC	±0.0001		ANGLES	
Ø	PLC	±0.1															
	PLC	±0.01															
	PLC	±0.001															
	PLC	±0.0001															
	ANGLES																
MATERIAL: -		APPLICATION SPEC: -	RESTRICTED TO: -														
FINISH: -		WEIGHT: -	SIZE: A200779														
CUSTOMER DRAWING		REWORK NO: 1738916	SCALE: 5:2 SHEET 2 OF 2 REV A														