

NOT DRAWING TO DIMENSIONS
 IF THIS ELECTRICAL COMPONENT IS TO BE USED IN A DIFFERENT APPLICATION

REV	DATE	REVISIONS	BY	CHK	APP'D
B	07.02.01	REVISED FOR 0138-013	HS	CS	
C	07.23.01	REVISED FOR 0145-013	HS	CS	
D	07.23.01	REVISED FOR 0145-013	HS	CS	
E	07.23.01	REVISED FOR 0145-013	HS	CS	
F	07.23.01	REVISED FOR 0145-013	HS	CS	
G	07.23.01	REVISED FOR 0145-013	HS	CS	

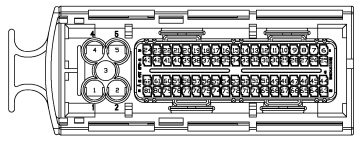

PART NUMBER	BLANKED CAVITIES
368376-4	6,8,10,21,25-28,33,34,41,42, 46-49,53,61,65-68,70,72,74,80,81.
368376-3	14-16,20,30,32-35,37,39, 43-47,53-59,72-75,77.
368376-2	7,9,10,14-16,20,27,30,32-35,37, 39,45-47,52-59,67,68,72-75,77.
368376-1	-

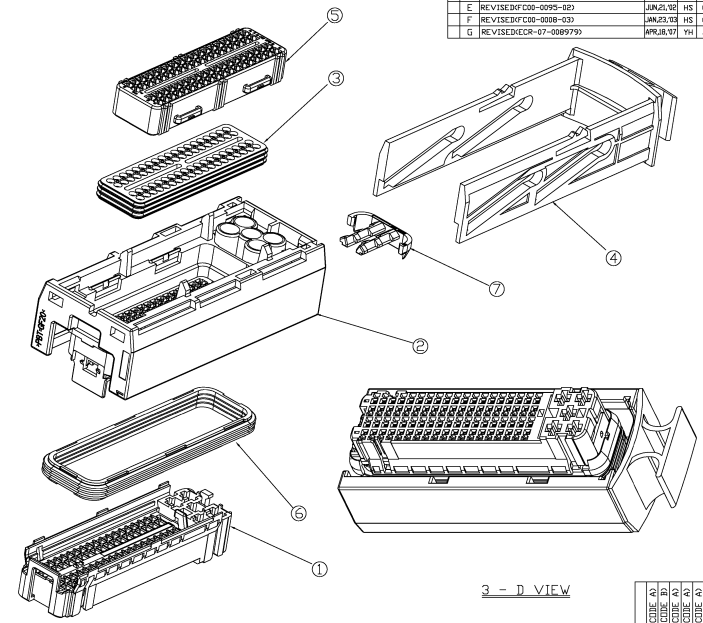
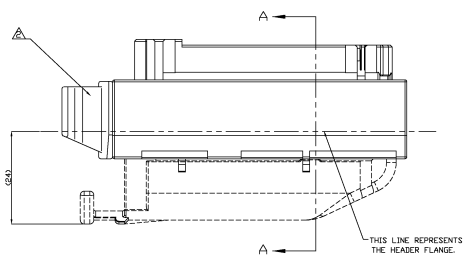
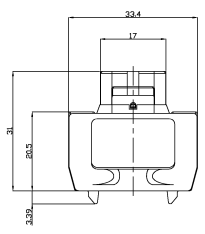
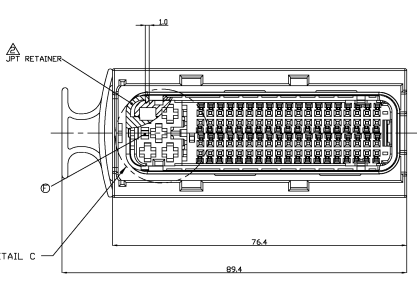
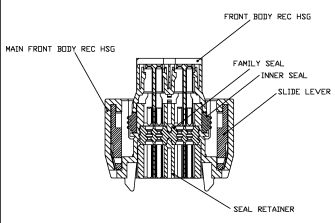
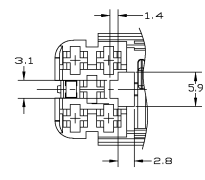
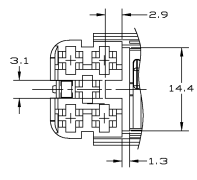

NOTES

- GENERAL TOLERANCE IS ±0.5
- CONDITION OF DELIVERY - SLIDE LEVER IN CLOSED POSITION, JPT RETAINER IN OPEN POSITION.
- SUITABLE FOR WIRE SIZE RANGE.
- APPLIED COVER HSG P/N 368389
- APPLIED RECEPTACLE CONTACT P/N
- APPLIED HEADER ASSEMBLY P/N 368146.

CIRCUIT NO.	MGS	JPT
6 - 81	1 - 5	

WIRE SIZE(mm²) 0.5 - 0.75 0.5 - 2.5

CONTACT	MGS	JPT
Part. NO.	968020	964221
1 - 368376-1	0.5	0.75
1 - 368376-2	0.5	1.0
1 - 368376-3	0.5	1.0
1 - 368376-4	0.5	1.0

NO.	Part. NO.	DESCRIPTION	MATERIAL	COLOR	QTY
7	368381-1	JPT RETAINER	PBT-GF30	YELLOW	1
6	368380-1	INNER SEAL FOR 81P	SILICONE	ORANGE	1
5	368380-3	SEAL RETAINER FOR 81P	PBT-GF15	WHITE	1
	368380-2			GRAY	1
	368380-1			BLACK	1
4	368379-1	SLIDE LEVER FOR 81P	PA66-GF30	BLACK	1
3	368394-1	7P FAMILY SEAL	SILICONE	ORANGE	1
2	368378-1	MAIN BODY REC. HSG FOR 81P	PBT-GF20	BLACK	1
1	368377-2	FRONT BODY REC. HSG FOR 81P(CODE B)	PA66-GF15	RED	1
1	368377-1	FRONT BODY REC. HSG FOR 81P(CODE A)	PA66-GF15	BLACK	1

NO.	Part. NO.	DESCRIPTION	MATERIAL	COLOR	QTY
7	368381-1	JPT RETAINER	PBT-GF30	YELLOW	1
6	368380-1	INNER SEAL FOR 81P	SILICONE	ORANGE	1
5	368380-3	SEAL RETAINER FOR 81P	PBT-GF15	WHITE	1
	368380-2			GRAY	1
	368380-1			BLACK	1
4	368379-1	SLIDE LEVER FOR 81P	PA66-GF30	BLACK	1
3	368394-1	7P FAMILY SEAL	SILICONE	ORANGE	1
2	368378-1	MAIN BODY REC. HSG FOR 81P	PBT-GF20	BLACK	1
1	368377-2	FRONT BODY REC. HSG FOR 81P(CODE B)	PA66-GF15	RED	1
1	368377-1	FRONT BODY REC. HSG FOR 81P(CODE A)	PA66-GF15	BLACK	1

AMP KOREA, Kyungsoon, Korea

81Pos RECEPTACLE HSG ASSEMBLY

00779 368376

CUSTOMER DRAWING