

THIS DRAWING IS UNPUBLISHED
 © COPYRIGHT 1997 BY _____ ALL RIGHTS RESERVED.

LDC		DIST		REVISIONS			
P	LTR	DESCRIPTION	DATE	DWN	APVD		
B1		REVISED PER ECO-11-005139	28MAR11	RK	HMR		

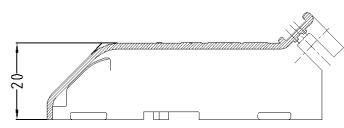

SECTION A-A

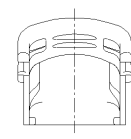
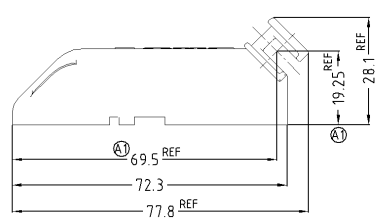
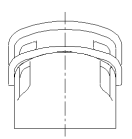
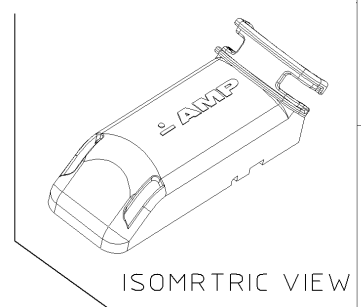
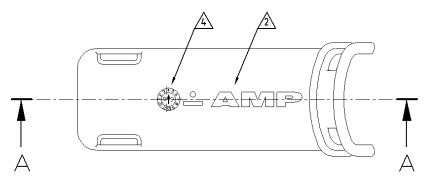
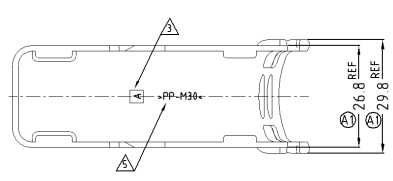

NOTE:
 1. APPLICABLE ASS'Y CONNECTOR FOR JPT&MQS 81Pos.; P/N: 368190-1
 ▲ TREAD MARK.
 ▲ CAVITY MARK.
 ▲ DATE CODE.
 ▲ RECYCLE MARKING.

②	COLOR	MATERIAL	DESCRIPTION	PART NO.
	BLACK	PP-M30	COVER HSG (CHINA ONLY)	9-368333-1
	BLACK	PP-M30	COVER HSG	368333-1

DWN DR GDD		STE TE Connectivity	
CHK YM CHOI			
APVD JK SONG		NAME	
PRODUCT SPEC ---		COVER HSG FOR JPT&MQS ASS'Y 81Pos. ('B' TYPE)	
APPLICATION SPEC ---		DRAWING NO	
WEIGHT ---		SIZE A3	CAGE CODE 00779
MATERIAL SEE TABLE		DRAWING NO 368333	
FINISH SEE TABLE		SCALE 1 : 1	
CUSTOMER DRAWING		SHEET 1 OF 1	
		REV B1	

AMP 1470-19 REV 09MAY94