

4

3

2

1

THIS DRAWING IS UNPUBLISHED. RELEASED FOR PUBLICATION
 COPYRIGHT © BY TYCO ELECTRONICS CORPORATION. ALL RIGHTS RESERVED.

LOC	DEST	REVISIONS			
P	LTR	DESCRIPTION	DATE	OWN	APPV
P		REVISED (FC00-0039-02)	22.MAR.'02	MS	CS
R		REVISED (FC00-0002-03)	16.JUN.'03	MS	CS
S		REVISED (FC00-0072-03)	05.JUN.'04	YD.	CS
T		REVISED (FC00-0008-04)	05.FEB.'04	YD.	CS
U		REVISED (FC00-0046-04)	23.MAR.'04	YD.	CS
V		REVISED (FC00-0097-04)	28.MAY.'04	YD.	CS

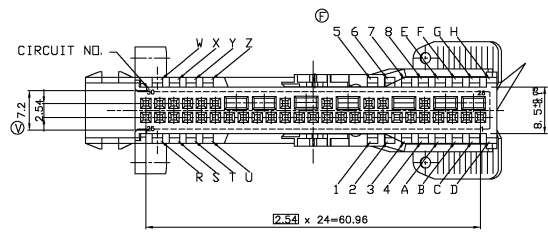
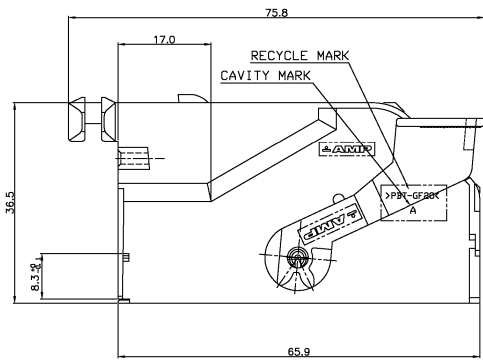
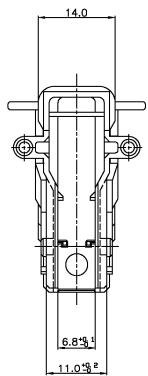
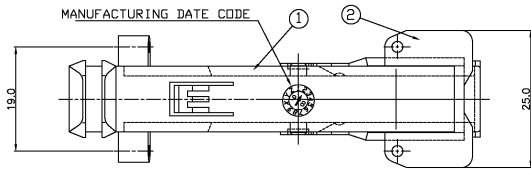

NOTE
 1. DRAWING KEY IS <D-H>
 2. APPLICABLE PLUG HOUSING ASS'Y: P/N 368233

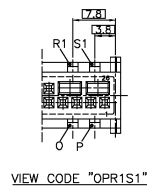
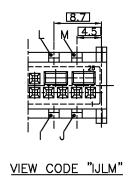

ITEM NO.	DESCRIPTION	P/N	COLOR	Q'TY
2	LEVER HOUSING	368235-1	BLACK	1
1	COVER HOUSING	SEE TABLE	SEE TABLE	1

DIMENSIONS: MM TOLERANCES UNLESS OTHERWISE SPECIFIED: 0 XXXX ± 0.2 150000 ± 0.25 30000 ± 0.3 ANGLES ± 3° 3rd ANGLE PROJECTION MATERIAL: SEE TABLE FINISH: SEE TABLE	DWG. NO. HER CRK. BK. JANG APVD. / CS. LEE NAME PRODUCT SPEC. APPLICATION SPEC. WEIGHT SIZE: CASE CODE: DRAWING NO. RESTRICTED TO A2 00779 368231 SCALE: 2/1 SHEET 1 OF 3 REV V
---	--

4

3

2

1

THIS DRAWING IS UNPUBLISHED. RELEASED FOR PUBLICATION.
 © COPYRIGHT BY TYCO ELECTRONICS CORPORATION. ALL RIGHTS RESERVED.

REV	DATE	BY	APPV	DESCRIPTION
1				SEE DRAWING 1/3

D

C

B

A

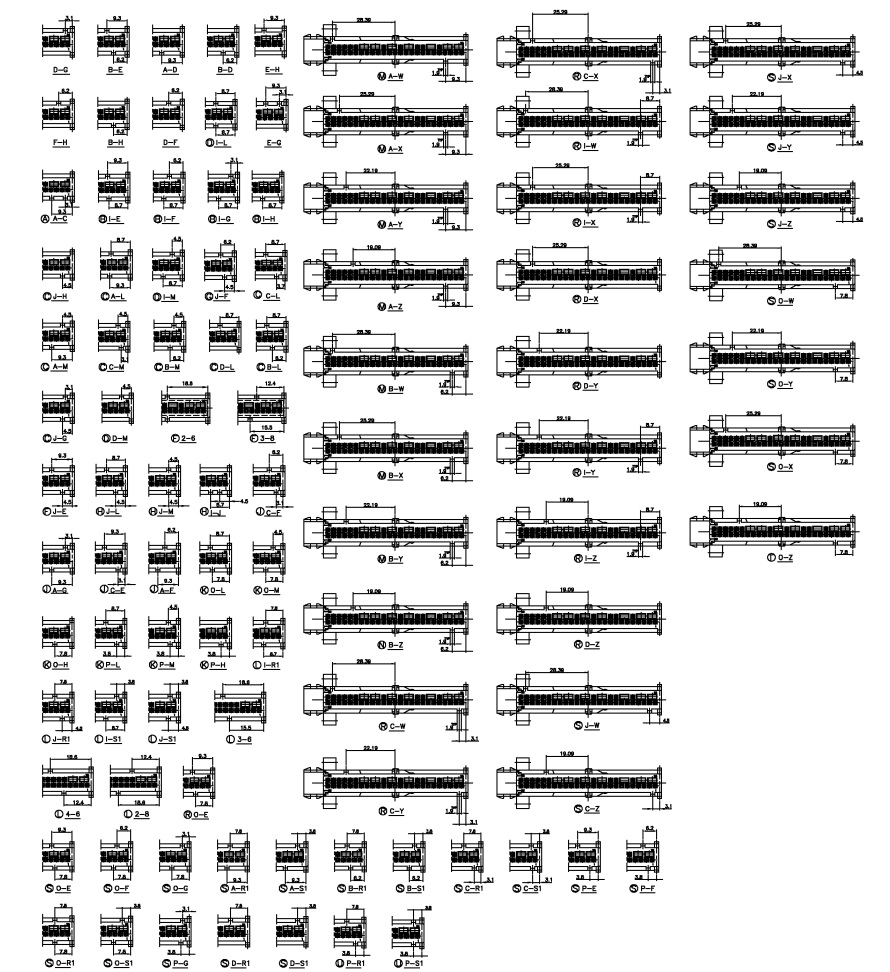

GEOMETRY CODE

		0-368231																		
		9	8	7	6	5	4	3	2	1	0									
②	0-368235-1	LEVER	HSG	PBT	GF20	BLACK														
①	0-368232-9					Gray White (Mat. 8223)	D-F	1	1	1	1	1	1	1	1	1	1	1	1	
①	0-368232-8					Black (Mat. 8225)	B-H	1												
①	0-368232-7					Universal Blue (Mat. 3525)	F-H		1											
①	0-368232-6					Frontal Green (Mat. 8218)	E-H		1											
①	0-368232-5					Blue (Mat. 3517)	B-D			1										
①	0-368232-4					White (Mat. 3525)	A-D				1									
①	0-368232-3					Frontal Yellow (Mat. 1521)	O-R1					1								
①	0-368232-2					Light Pink (Mat. 3523)	B-E						1							
①	0-368232-1	COVER	HSG	PBT	GF20	Black (Mat. 8225)	D-G												1	
NO	PART NO	DESCRIPTION	MATERIAL	COLOR	CODE	REQUIRED PER ASSEMBLY														

		1-368231																		
		9	8	7	6	5	4	3	2	1	0									
②	0-368235-1	LEVER	HSG	PBT	GF20	BLACK														
①	1-368232-9					Gray White (Mat. 8223)	J-G	1	1	1	1	1	1	1	1	1	1	1	1	
①	1-368232-8					Heater Violet (Mat. 8223)	J-F	1												
①	1-368232-7					Gray Yellow (Mat. 8223)	J-E		1											
①	1-368232-6					Red (Mat. 8223)	I-H			1										
①	1-368232-5					Blue (Mat. 3517)	I-G				1									
①	1-368232-4					Signal Yellow (Mat. 1521)	I-F					1								
①	1-368232-3					Green (Mat. 1521)	I-E						1							
①	1-368232-2					Light Gray (Mat. 7533)	A-C												1	
①	1-368232-0	COVER	HSG	PBT	GF20	Solution Pink (Mat. 3522)	O-W												1	
NO	PART NO	DESCRIPTION	MATERIAL	COLOR	CODE	REQUIRED PER ASSEMBLY														

DIMENSIONS: MM		TOLERANCES UNLESS OTHERWISE SPECIFIED: 0.00X0.0 ± 0.2 15.00X0.0 ± 0.25 30.00X ± 0.3 ANGLES ± 3°		DWN: YB LEE CRK: BN JANG APVD: GS LEE DATE: 07/19/03				AMP KOREA, kyongsan, korea	
3rd ANGLE PROJECTION		FINISH: SEE TABLE		VEINISH: SEE TABLE		PRODUCT SPEC: APPLICATION SPEC:		AIRBAG 50P COVER ASS'Y CASE CODE: DRAWING NO: 00779 DRAWING NO: 368231	
MATERIAL: SEE TABLE		RESTRICTED TO		SCALE: 2/1		SHEET: 2		REV: V	

4

3

2

1

THIS DRAWING IS UNPUBLISHED. RELEASED FOR PUBLICATION.
 © COPYRIGHT BY TYCO ELECTRONICS CORPORATION. ALL RIGHTS RESERVED.

LOC	REV	DATE	BY	APPV
DS				
P LTR		DESCRIPTION		
SEE DRAWING 1/3				

2-368231						
QTY	0-368235-1	LEVER HSG	PBT GF20	BLACK	CODE	
1	2-368232-9			Orange Black (MIL 9011)	B-D	
1	2-368232-6			Blue Lites (MIL 4005)	C-M	
1	2-368232-7			Clear Violet (MIL 4004)	B-M	
1	2-368232-6			Yellow Green (MIL 2008)	A-M	
1	2-368232-5			Black Gray (MIL 7012)	D-L	
1	2-368232-4			Tricarbonyl Yellow (MIL 1023)	C-L	
1	2-368232-3			Tricarbonyl Blue (MIL 1023)	B-L	
1	2-368232-2			Leaf Green (MIL 2007)	A-L	
1	2-368232-1			Orange Brown (MIL 4003)	J-H	
1	2-368232-0	COVER HSG	PBT GF20	Orange Black (MIL 4003)	O-X	
NO	PART NO	DESCRIPTION	MATERIAL	COLOR	CODE	REQUIRED PER ASSEMBLY

5-368231						
QTY	0-368235-1	LEVER HSG	PBT GF20	BLACK	CODE	
1	5-368232-9			Blue Green (MIL 4005)	A-X	
1	5-368232-8			Forest Blue (MIL 5014)	A-W	
1	5-368232-7			Light Blue (MIL 2008)	3-6	
1	5-368232-6			Blue Lites (MIL 4005)	2-6	
1	5-368232-5			Blue Lites (MIL 4005)	4-6	
1	5-368232-4			Forest Blue (MIL 5014)	J-S1	
1	5-368232-3			Orange White (MIL 4003)	I-S1	
1	5-368232-2			Forest Blue (MIL 5014)	J-R1	
1	5-368232-1			Orange Black (MIL 4003)	I-S1	
1	5-368232-0	COVER HSG	PBT GF20	Orange Black (MIL 4003)	P-R1	
NO	PART NO	DESCRIPTION	MATERIAL	COLOR	CODE	REQUIRED PER ASSEMBLY

8-368231						
QTY	0-368235-1	LEVER HSG	PBT GF20	BLACK	CODE	
1	8-368232-9			Green Beige (MIL 2005)	P-E	
1	8-368232-8			Red Beige (MIL 2005)	C-Z	
1	8-368232-7			Headlight Violet (MIL 4003)	C-S1	
1	8-368232-6			Tricarbonyl Purple (MIL 1023)	C-R1	
1	8-368232-5			Blue Lites (MIL 4005)	B-S1	
1	8-368232-4			Purple Violet (MIL 4007)	B-R1	
1	8-368232-3			Leaf Green (MIL 2007)	A-S1	
1	8-368232-2	COVER HSG	PBT GF20	Leaf Green (MIL 2007)	A-R1	
1	8-368232-1	COVER HSG	PBT GF20	Leaf Green (MIL 2007)	O-G	
NO	PART NO	DESCRIPTION	MATERIAL	COLOR	CODE	REQUIRED PER ASSEMBLY

3-368231						
QTY	0-368235-1	LEVER HSG	PBT GF20	BLACK	CODE	
1	3-368232-9			Leaf Green (MIL 2007)	C-F	
1	3-368232-8			Orange (MIL 1001)	I-J	
1	3-368232-7			Tricarbonyl Blue (MIL 1023)	J-M	
1	3-368232-6			Orange Blue (MIL 5001)	J-L	
1	3-368232-5			Orange Blue (MIL 5001)	3-B	
1	3-368232-4			Signal Yellow (MIL 1003)	2-B	
1	3-368232-3			Orange Black (MIL 4003)	I-M	
1	3-368232-2			Orange Black (MIL 4003)	I-L	
1	3-368232-1			Light Blue (MIL 2008)	D-M	
1	3-368232-0	COVER HSG	PBT GF20	Orange White (MIL 4003)	O-Y	
NO	PART NO	DESCRIPTION	MATERIAL	COLOR	CODE	REQUIRED PER ASSEMBLY

6-368231						
QTY	0-368235-1	LEVER HSG	PBT GF20	BLACK	CODE	
1	6-368232-9			Luminous Orange (MIL 2005)	C-X	
1	6-368232-8			Orange (MIL 1001)	C-W	
1	6-368232-7			Leaf Green (MIL 2007)	O-E	
1	6-368232-6			Tricarbonyl Green (MIL 1023)	B-Z	
1	6-368232-5			Purple Violet (MIL 4007)	B-Y	
1	6-368232-4			Orange Black (MIL 4003)	B-X	
1	6-368232-3			Light Green (MIL 2007)	B-W	
1	6-368232-2			Black (MIL 9011)	A-Z	
1	6-368232-1			Luminous Orange (MIL 2005)	A-Y	
1	6-368232-0	COVER HSG	PBT GF20	Orange Black (MIL 4003)	P-S1	
NO	PART NO	DESCRIPTION	MATERIAL	COLOR	CODE	REQUIRED PER ASSEMBLY

9-368231						
QTY	0-368235-1	LEVER HSG	PBT GF20	BLACK	CODE	
1	9-368232-9			Signal Violet (MIL 4003)	O-S1	
1	9-368232-8			Leaf Green (MIL 2007)	J-Z	
1	9-368232-7			Leaf Green (MIL 2007)	J-Y	
1	9-368232-6			Orange (MIL 1001)	J-X	
1	9-368232-5			Tricarbonyl Green (MIL 1023)	J-W	
1	9-368232-4			Orange Black (MIL 4003)	D-S1	
1	9-368232-3			Orange Black (MIL 4003)	D-R1	
1	9-368232-2			Orange Black (MIL 4003)	P-G	
1	9-368232-1	COVER HSG	PBT GF20	Signal Yellow (MIL 1003)	P-F	
NO	PART NO	DESCRIPTION	MATERIAL	COLOR	CODE	REQUIRED PER ASSEMBLY

4-368231						
QTY	0-368235-1	LEVER HSG	PBT GF20	BLACK	CODE	
1	4-368232-9			White Aluminum (MIL 2005)	P-H	
1	4-368232-8			Blue Gray (MIL 7012)	P-M	
1	4-368232-7			Orange Red (MIL 5011)	P-L	
1	4-368232-6			Red Brown (MIL 9011)	O-H	
1	4-368232-5			Tricarbonyl Purple (MIL 1023)	O-M	
1	4-368232-4			Leaf Green (MIL 2007)	O-L	
1	4-368232-3			Orange Black (MIL 4003)	A-F	
1	4-368232-2			Headlight Violet (MIL 4003)	C-E	
1	4-368232-1			Orange White (MIL 4003)	O-Z	
1	4-368232-0	COVER HSG	PBT GF20	Orange White (MIL 4003)	A-G	
NO	PART NO	DESCRIPTION	MATERIAL	COLOR	CODE	REQUIRED PER ASSEMBLY

7-368231						
QTY	0-368235-1	LEVER HSG	PBT GF20	BLACK	CODE	
1	7-368232-9			Orange Red (MIL 5011)	O-F	
1	7-368232-8			Orange Blue (MIL 5001)	D-Z	
1	7-368232-7			Tricarbonyl Red (MIL 1023)	I-Z	
1	7-368232-6			Tricarbonyl Green (MIL 1023)	I-Y	
1	7-368232-5			Light Green (MIL 2007)	D-Y	
1	7-368232-4			Red Brown (MIL 9011)	D-X	
1	7-368232-3			Tricarbonyl Blue (MIL 1023)	I-X	
1	7-368232-2			Headlight Violet (MIL 4003)	I-W	
1	7-368232-1	COVER HSG	PBT GF20	Red Brown (MIL 9011)	O-Y	
NO	PART NO	DESCRIPTION	MATERIAL	COLOR	CODE	REQUIRED PER ASSEMBLY

DIMENSIONS: MM 3rd ANGLE PROJECTION SEE TABLE		TOLERANCES UNLESS OTHERWISE SPECIFIED 0.00010 ± 0.2 18.00000 ± 0.25 30.000 ± 0.3 ANGLES ± 3°		DWG. TFL LEE CHK. BYN JANG APVD. BY CS LEE SEE DRAWING 1/3		tyco Electronics AMP KOREA, kyungsan, korea	
MATERIAL: SEE TABLE		FINISH: SEE TABLE		NAME: AIRBAG 50P COVER ASS'Y		SIZE: CASE CODE DRAWING NO: A200779 © 368231	
RESTRICTED TO:		SCALE: 2/1		SHEET: 3 OF 3		REV: V	