

NOT BEING TO OPERATE. RECESS FOR PROTECTION.  
 IF THIS ELECTRICAL COMPONENT IS NOT RECESSED

REV	DATE	REVISIONS	BY	CHK	APP
S		REVISED (FC00-0039-02)	SH/AN	YS	CS
T		REVISED (FC00-0002-03)	SH/AN	YS	CS
U		REVISED (FC00-0072-03)	SH/AN	YS	CS
V		REVISED (FC00-0008-04)	SH/AN	YS	CS
W		REVISED (FC00-0048-04)	SH/AN	YS	CS
Y		REVISED (EGR-06-028031)	HA/PM/SH	BH	JK

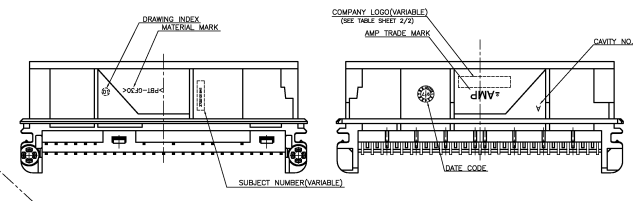

- NOTES**
- PIN CONTACT :  $\pm 0.03$
  - MATERIAL : Cu96
  - FINISH : SEE TABLE SHEET 2/2.
  - SLECTING FORCE IN DIRECTION OF CONNECTION (DETECTION AS SEPARATE OPERATION)
    - >20N but  $\leq 200\text{mm/min}$ , AFTER SOLDERING STRESS
    - >40N but  $\leq 100\text{mm/min}$
  - ENVIRONMENTAL REQUIREMENTS ACCORDING TO AMP SPEC 108-61031
    - NO MOSHIR-EFFECT BY ASSEMBLY FORCE  $\leq 50\text{N}$
    - DRAWING KEY B (D-H)
    - FREE OF LOOSE METAL PARTS
    - PIN CONNECTOR : FREE OF CADMIUM ( $\leq 50\text{ppm}$ )
  - INSULATING BODY
    - MATERIAL : PBT + GF30K
    - COLOR : CONSULT THE DRAWING
    - ALLOWED RECYCLED MATERIAL MAX 25%
  - IN THE AREA OF MOSHIR FREE SPACE THERE IS UP TO  $\pm 0.2$  PERMISSIBLE
  - SOLDERING AREA
  - MEASURED TO THE CENTER LINE OF THE INSULATING BODY
  - CONNECTIONS SUITABLE FOR HOLE DIAMETER 1.3, SEE PC-BOARD LAYOUT
  - MEASURED AT PIN TOP (7MM ABOVE BOTTOM)
  - MEASURED AT THE BOTTOM
  - MEASUREMENT POINTS FOR REFERENCE (A) AND (B)
  - MEASUREMENT POINTS FOR REFERENCE (C) AND (D)

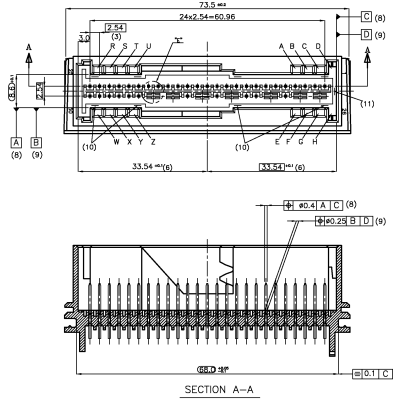
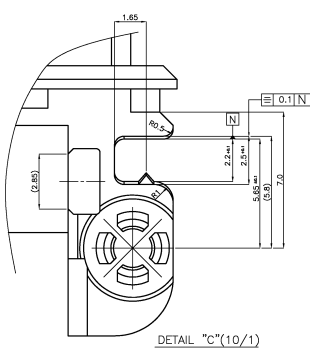
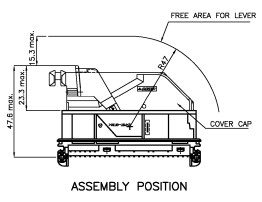
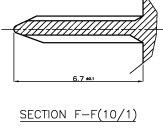
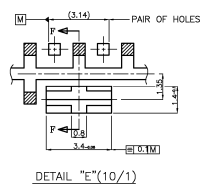
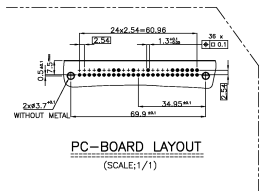
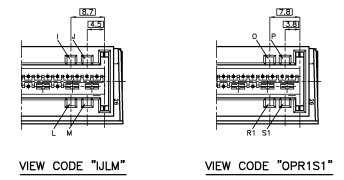
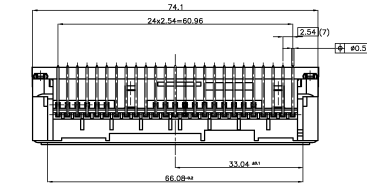
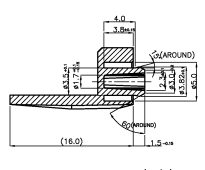
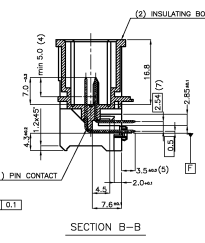
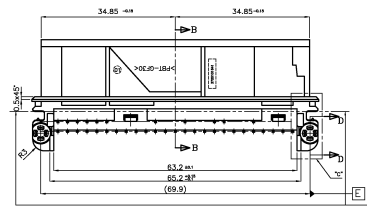
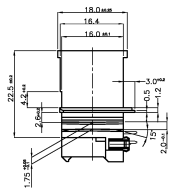

WORLDWIDE ELECTRONIC COMPONENTS DISTRIBUTOR	DATE IN USE	AMP KOREA
DATE IN USE	DATE IN USE	kyungson, Korea
PROJECT SPEC	PROJECT SPEC	AIR BAG 50P HEADER ASSY
APPLICATION SPEC	DATE CODE (REVISED NO)	00779 368213
REVISION	CUSTOMER DRAWING	SCALE: 2/1 SHEET 1 OF 2 REV. Y

KEY-CODE LAYOUT

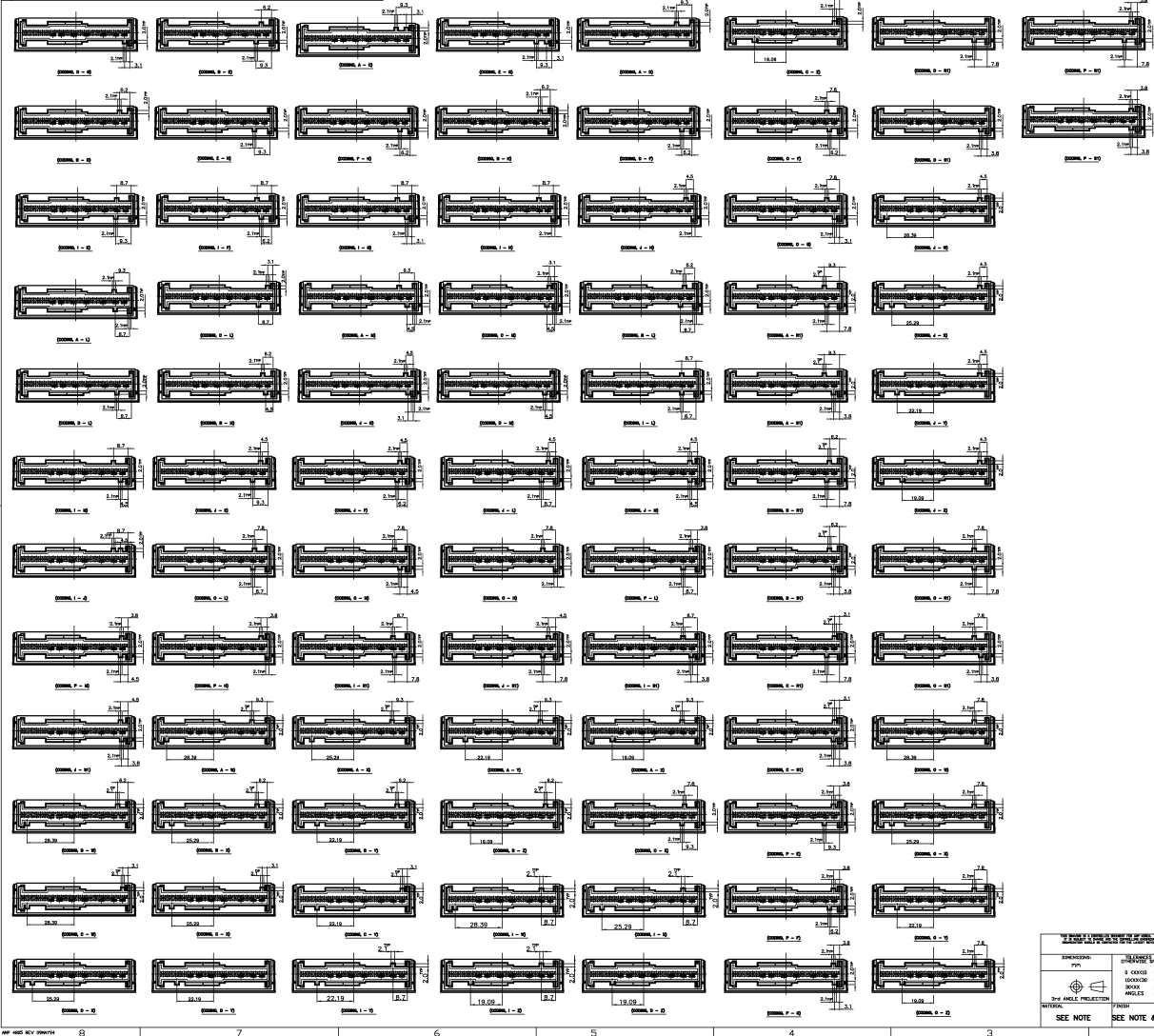

REVISONS		DATE	BY	CHK	APPV
1	INITIAL				

SEE 1 OF 2 SHEET

NO.	REVISION	DATE	BY	CHK	APPV
1.1	INITIAL				
1.2	INITIAL				
1.3	INITIAL				
1.4	INITIAL				
1.5	INITIAL				
1.6	INITIAL				
1.7	INITIAL				
1.8	INITIAL				
1.9	INITIAL				
1.10	INITIAL				
1.11	INITIAL				
1.12	INITIAL				
1.13	INITIAL				
1.14	INITIAL				
1.15	INITIAL				
1.16	INITIAL				
1.17	INITIAL				
1.18	INITIAL				
1.19	INITIAL				
1.20	INITIAL				
1.21	INITIAL				
1.22	INITIAL				
1.23	INITIAL				
1.24	INITIAL				
1.25	INITIAL				
1.26	INITIAL				
1.27	INITIAL				
1.28	INITIAL				
1.29	INITIAL				
1.30	INITIAL				
1.31	INITIAL				
1.32	INITIAL				
1.33	INITIAL				
1.34	INITIAL				
1.35	INITIAL				
1.36	INITIAL				
1.37	INITIAL				
1.38	INITIAL				
1.39	INITIAL				
1.40	INITIAL				
1.41	INITIAL				
1.42	INITIAL				
1.43	INITIAL				
1.44	INITIAL				
1.45	INITIAL				
1.46	INITIAL				
1.47	INITIAL				
1.48	INITIAL				
1.49	INITIAL				
1.50	INITIAL				
1.51	INITIAL				
1.52	INITIAL				
1.53	INITIAL				
1.54	INITIAL				
1.55	INITIAL				
1.56	INITIAL				
1.57	INITIAL				
1.58	INITIAL				
1.59	INITIAL				
1.60	INITIAL				
1.61	INITIAL				
1.62	INITIAL				
1.63	INITIAL				
1.64	INITIAL				
1.65	INITIAL				
1.66	INITIAL				
1.67	INITIAL				
1.68	INITIAL				
1.69	INITIAL				
1.70	INITIAL				
1.71	INITIAL				
1.72	INITIAL				
1.73	INITIAL				
1.74	INITIAL				
1.75	INITIAL				
1.76	INITIAL				
1.77	INITIAL				
1.78	INITIAL				
1.79	INITIAL				
1.80	INITIAL				
1.81	INITIAL				
1.82	INITIAL				
1.83	INITIAL				
1.84	INITIAL				
1.85	INITIAL				
1.86	INITIAL				
1.87	INITIAL				
1.88	INITIAL				
1.89	INITIAL				
1.90	INITIAL				
1.91	INITIAL				
1.92	INITIAL				
1.93	INITIAL				
1.94	INITIAL				
1.95	INITIAL				
1.96	INITIAL				
1.97	INITIAL				
1.98	INITIAL				
1.99	INITIAL				
1.100	INITIAL				

AMP KOREA  
 Kyungson, Korea  
**AIR BAG 50P HEADER ASS'Y**  
 DRAWING NO. 100779  
 DATE 2/1/07  
 REV. 2