

4

3

2

1

THIS DRAWING IS UNPUBLISHED. RELEASED FOR PUBLICATION
 COPYRIGHT © BY TYCO ELECTRONICS CORPORATION. ALL RIGHTS RESERVED.

LOC	DEST	REVISIONS			
P	LTR	DESCRIPTION	DATE	OWN	APPV
P		REVISED (FC00-0039-02)	22.MAR.02	MS	CS
R		REVISED (FC00-0002-03)	16.JUN.03	MS	CS
S		REVISED (FC00-0072-03)	05.JUN.03	YD.	CS
T		REVISED (FC00-0008-04)	05.FEB.04	YD.	CS
U		REVISED (FC00-0046-04)	23.MAR.04	YD.	CS
V		REVISED (FC00-0097-04)	28.MAY.04	YD.	CS

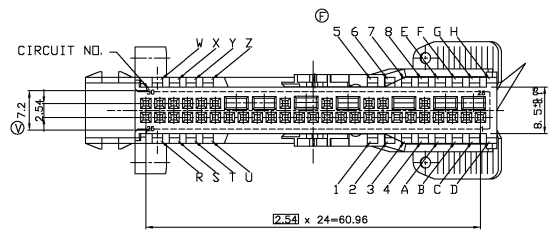
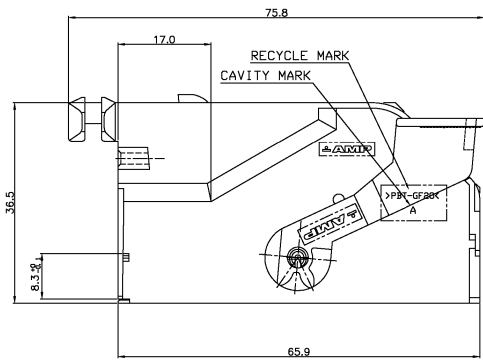
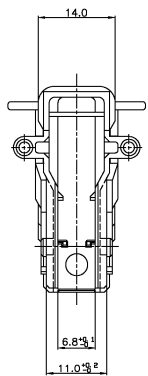
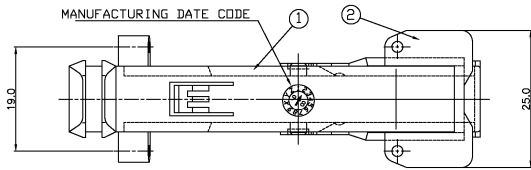

NOTE
 1. DRAWING KEY IS <D-H>
 2. APPLICABLE PLUG HOUSING ASS'Y: P/N 368233

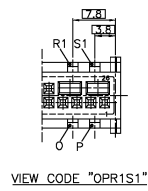
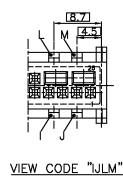

ITEM NO.	DESCRIPTION	P/N	COLOR	Q'TY
2	LEVER HOUSING	368235-1	BLACK	1
1	COVER HOUSING	SEE TABLE	SEE TABLE	1

DIMENSIONS: MM TOLERANCES UNLESS OTHERWISE SPECIFIED: 0 XXXX ± 0.2 150000 ± 0.25 30000 ± 0.3 ANGLES ± 3° 3rd ANGLE PROJECTION MATERIAL: SEE TABLE FINISH: SEE TABLE	DWG. NO. HER CRK. BK. JANG APVD. / CS. LEE NAME: tyco Electronics AMP KOREA, kyungsan, korea PRODUCT SPEC: APPLICATION SPEC: SIZE: A2 CASE CODE: 00779 DRAWING NO: 368231 RESTRICTED TO:
---	--

4

3

2

1

THIS DRAWING IS UNPUBLISHED. RELEASED FOR PUBLICATION.
 © COPYRIGHT BY TYCO ELECTRONICS CORPORATION. ALL RIGHTS RESERVED.

REV. NO.	DATE	BY	APP'D
1			

DESCRIPTION: SEE DRAWING 1/3

2-368231

NO	PART NO	DESCRIPTION	MATERIAL	COLOR	CODE	REQUIRED PER ASSEMBLY
②	0-368235-1	LEVER HSG	PBT GF20	BLACK		1
①	2-368232-9			Orange Black (NL 9011)	B-D	1
①	2-368232-6			Blue Lites (NL 4005)	C-M	1
①	2-368232-7			Clear Violet (NL 4004)	B-M	1
①	2-368232-6			Yellow Green (NL 2006)	A-M	1
①	2-368232-5			Black Gray (NL 7012)	D-L	1
①	2-368232-4			Traffic Purple (NL 1003)	C-L	1
①	2-368232-3			Translucent Black (NL 1002)	B-L	1
①	2-368232-2			Leaf Green (NL 5007)	A-L	1
①	2-368232-1			Clay Brown (NL 4003)	J-H	1
①	2-368232-0	COVER HSG	PBT GF20	White Violet (NL 4006)	O-X	1
NO	PART NO	DESCRIPTION	MATERIAL	COLOR	CODE	REQUIRED PER ASSEMBLY

5-368231

NO	PART NO	DESCRIPTION	MATERIAL	COLOR	CODE	REQUIRED PER ASSEMBLY
②	0-368235-1	LEVER HSG	PBT GF20	BLACK		1
①	5-368232-9			Blue Green (NL 8005)	A-X	1
①	5-368232-8			Forest Blue (NL 5014)	A-W	1
①	5-368232-7			Light Blue (NL 2004)	3-6	1
①	5-368232-6			Blue Lites (NL 4005)	2-6	1
①	5-368232-5			Blue Lites (NL 4005)	4-6	1
①	5-368232-4			Forest Green (NL 4002)	J-S1	1
①	5-368232-3			Orange White (NL 9011)	I-S1	1
①	5-368232-2			Forest Green (NL 4002)	J-R1	1
①	5-368232-1			Clay Brown (NL 4003)	I-R1	1
①	5-368232-0	COVER HSG	PBT GF20	Orange Black (NL 9011)	P-R1	1
NO	PART NO	DESCRIPTION	MATERIAL	COLOR	CODE	REQUIRED PER ASSEMBLY

8-368231

NO	PART NO	DESCRIPTION	MATERIAL	COLOR	CODE	REQUIRED PER ASSEMBLY
②	0-368235-1	LEVER HSG	PBT GF20	BLACK		1
①	8-368232-9			Green Beige (NL 1005)	P-E	1
①	8-368232-8			Red Red (NL 4004)	C-Z	1
①	8-368232-7			Headset Violet (NL 4003)	C-S1	1
①	8-368232-6			Traffic Purple (NL 1003)	C-R1	1
①	8-368232-5			Blue Lites (NL 4005)	B-S1	1
①	8-368232-4			Purple Violet (NL 4007)	B-R1	1
①	8-368232-3			Leaf Green (NL 5007)	A-S1	1
①	8-368232-2	COVER HSG	PBT GF20	Leaf Green (NL 5007)	A-R1	1
①	8-368232-1	COVER HSG	PBT GF20	Leaf Green (NL 5007)	O-G	1
NO	PART NO	DESCRIPTION	MATERIAL	COLOR	CODE	REQUIRED PER ASSEMBLY

3-368231

NO	PART NO	DESCRIPTION	MATERIAL	COLOR	CODE	REQUIRED PER ASSEMBLY
②	0-368235-1	LEVER HSG	PBT GF20	BLACK		1
①	3-368232-9			Leaf Green (NL 5007)	C-F	1
①	3-368232-8			Clay Brown (NL 4003)	I-J	1
①	3-368232-7			Forest Blue (NL 5017)	J-M	1
①	3-368232-6			Orange Blue (NL 5001)	J-L	1
①	3-368232-5			Orange Blue (NL 5001)	3-B	1
①	3-368232-4			Signal Yellow (NL 5003)	2-B	1
①	3-368232-3			Orange Black (NL 9011)	I-M	1
①	3-368232-2			Leaf Green (NL 5007)	I-L	1
①	3-368232-1			Light Blue (NL 2004)	D-M	1
①	3-368232-0	COVER HSG	PBT GF20	Orange White (NL 9012)	O-Y	1
NO	PART NO	DESCRIPTION	MATERIAL	COLOR	CODE	REQUIRED PER ASSEMBLY

6-368231

NO	PART NO	DESCRIPTION	MATERIAL	COLOR	CODE	REQUIRED PER ASSEMBLY
②	0-368235-1	LEVER HSG	PBT GF20	BLACK		1
①	6-368232-9			Luminous Green (NL 2008)	C-X	1
①	6-368232-8			Clay Brown (NL 4003)	C-W	1
①	6-368232-7			Clay Brown (NL 4003)	O-E	1
①	6-368232-6			Translucent Green (NL 1001)	B-Z	1
①	6-368232-5			Forest Green (NL 4002)	B-Y	1
①	6-368232-4			Forest Green (NL 4002)	B-X	1
①	6-368232-3			Light Green (NL 3001)	B-W	1
①	6-368232-2			Black (NL 9001)	A-Z	1
①	6-368232-1			Luminous Green (NL 2008)	A-Y	1
①	6-368232-0	COVER HSG	PBT GF20	Red (NL 4001)	P-S1	1
NO	PART NO	DESCRIPTION	MATERIAL	COLOR	CODE	REQUIRED PER ASSEMBLY

9-368231

NO	PART NO	DESCRIPTION	MATERIAL	COLOR	CODE	REQUIRED PER ASSEMBLY
②	0-368235-1	LEVER HSG	PBT GF20	BLACK		1
①	9-368232-9			Signal Violet (NL 4007)	O-S1	1
①	9-368232-8			Leaf Green (NL 5007)	J-Z	1
①	9-368232-7			Clay Brown (NL 4003)	J-Y	1
①	9-368232-6			Black (NL 9001)	J-X	1
①	9-368232-5			Translucent Green (NL 1001)	J-W	1
①	9-368232-4			Clay Brown (NL 4003)	J-V	1
①	9-368232-3			Translucent Green (NL 1001)	D-S1	1
①	9-368232-2			Translucent Green (NL 1001)	D-R1	1
①	9-368232-1	COVER HSG	PBT GF20	Signal Yellow (NL 5003)	P-G	1
①	9-368232-0	COVER HSG	PBT GF20	Signal Yellow (NL 5003)	P-F	1
NO	PART NO	DESCRIPTION	MATERIAL	COLOR	CODE	REQUIRED PER ASSEMBLY

4-368231

NO	PART NO	DESCRIPTION	MATERIAL	COLOR	CODE	REQUIRED PER ASSEMBLY
②	0-368235-1	LEVER HSG	PBT GF20	BLACK		1
①	4-368232-9			White Aluminum (NL 2005)	P-H	1
①	4-368232-8			Blue Gray (NL 7013)	P-M	1
①	4-368232-7			Clay Brown (NL 4003)	P-L	1
①	4-368232-6			Red Brown (NL 8015)	O-H	1
①	4-368232-5			Traffic Purple (NL 1003)	O-M	1
①	4-368232-4			Forest Green (NL 4002)	O-L	1
①	4-368232-3			Blue Lites (NL 4005)	A-F	1
①	4-368232-2			Headset Violet (NL 4003)	C-E	1
①	4-368232-1			Orange White (NL 9012)	O-Z	1
①	4-368232-0	COVER HSG	PBT GF20	Clay Brown (NL 4003)	A-G	1
NO	PART NO	DESCRIPTION	MATERIAL	COLOR	CODE	REQUIRED PER ASSEMBLY

7-368231

NO	PART NO	DESCRIPTION	MATERIAL	COLOR	CODE	REQUIRED PER ASSEMBLY
②	0-368235-1	LEVER HSG	PBT GF20	BLACK		1
①	7-368232-9			Reddish Red (NL 4001)	O-F	1
①	7-368232-8			Orange Blue (NL 5017)	D-Z	1
①	7-368232-7			Traffic Red (NL 1002)	I-Z	1
①	7-368232-6			Platinum Gray (NL 3017)	I-Y	1
①	7-368232-5			Light Gray (NL 3015)	D-Y	1
①	7-368232-4			Red Brown (NL 8015)	D-X	1
①	7-368232-3			White (NL 9007)	I-X	1
①	7-368232-2			Reddish Red (NL 4001)	I-W	1
①	7-368232-1	COVER HSG	PBT GF20	Red Brown (NL 8015)	O-Y	1
NO	PART NO	DESCRIPTION	MATERIAL	COLOR	CODE	REQUIRED PER ASSEMBLY

DIMENSIONS: MM  3rd ANGLE PROJECTION SEE TABLE		TOLERANCES UNLESS OTHERWISE SPECIFIED: 0.00010 ± 0.2 18.00000 ± 0.25 30.000 ± 0.3 ANGLES ± 3° FINISH: SEE TABLE	DWG: YL LEE CHK: BN JANG APVD: GS LEE DATE: SEE DRAWING 1/3 NAME: AIRBAG 50P COVER ASS'Y SIZE: CASE CODE DRAWING NO: A200779 © 368231 RESTRICTED TO: SCALE 2/1 SHEET 3 OF 3 REV V
---	--	--	---