

IL4558

Dual Operational Amplifiers

The IL4558 is dual general purpose operational amplifiers. The high common-mode input voltage range and the absence of latch-up make these amplifiers ideal for voltage follower application.

The devices are short circuit protected and the internal frequency compensation ensures stability without external components.

- Short-Circuit Protection
- Wide common-mode and differential ranges
- No frequency compensation required
- Low power consumption
- No latch-up
- 3 MHz unity gain bandwidth guaranteed
- Gain and phase math between amplifiers

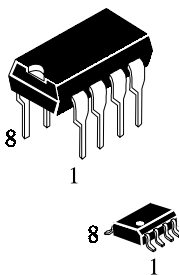

N SUFFIX PLASTIC

D SUFFIX SOIC

ORDERING INFORMATION
 IL4558N Plastic
 IL4558D SOIC
 $T_A = 0^\circ \text{ to } 70^\circ \text{ C}$ for all packages

PIN ASSIGNMENT

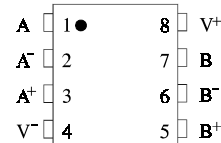

LOGIC DIAGRAM

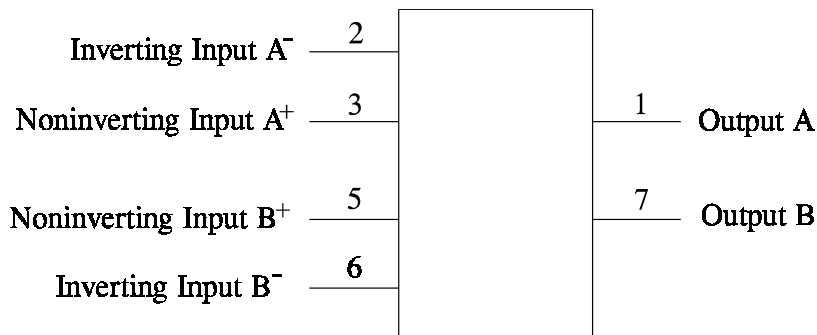

Pin 4 = Supply Voltage V⁻
 Pin 8 = Supply Voltage V⁺

MAXIMUM RATINGS*

Symbol	Parameter	Value	Unit
V ⁺	Supply Voltage	+18	V
V ⁻	Supply Voltage	-18	V
V _{IDR}	Differential Input Voltage	±30	V
V _{IN}	Input Voltage	±15	V
P _D	Power Dissipation in Still Air	570	mW
T _{stg}	Storage Temperature Range	-55 to +125	°C

* Maximum Ratings are those values beyond which damage to the device may occur. Functional operation should be restricted to the Recommended Operating Conditions.

RECOMMENDED OPERATING CONDITIONS

Symbol	Parameter	Min	Max	Unit
V ⁺	Supply Voltage		+15	V
V ⁻	Supply Voltage		-15	V
T _A	Operating Temperature, All Package Types	0	+70	°C

This device contains protection circuitry to guard against damage due to high static voltages or electric fields. However, precautions must be taken to avoid applications of any voltage higher than maximum rated voltages to this high-impedance circuit. For proper operation, V_{IN} and V_{OUT} should be constrained to the range $GND \leq (V_{IN} \text{ or } V_{OUT}) \leq V_{CC}$.

Unused inputs must always be tied to an appropriate logic voltage level (e.g., either GND or V_{CC}). Unused outputs must be left open.

ELECTRICAL CHARACTERISTICS($T_A = 0$ to $+70^\circ\text{C}$, $V^+ = +15\text{ V}$, $V^- = -15\text{ V}$)

Symbol	Parameter	Test Conditions	Guaranteed Limits			Unit
			Min	Typ	Max	
V_{IO}	Input Offset Voltage	$R_S \leq 10\text{ K}\Omega$			± 5.0	mV
I_{IO}	Input Offset Current				± 200	nA
I_{IB}	Input Bias Current				- 500	nA
r_i	Input Resistance		0.3			M Ω
A_V	Large-Signal Voltage Gain	$R_L \geq 2\text{ K}\Omega$, $V_C = \pm 10\text{ V}$	20			V/mV
V_{OM}	Output Voltage Swing	$R_L \geq 10\text{ K}\Omega$	± 12			V
		$R_L \geq 2\text{ K}\Omega$	± 10			V
V_{ICR}	Input Common-Mode Voltage Range		± 12			V
CMRR	Common Mode Rejection Ratio	$R_S \leq 10\text{ K}\Omega$	70			dB
PSRR	Supply Voltage Rejection Ratio	$R_S \leq 10\text{ K}\Omega$			150	$\mu\text{V/V}$
I^+, I^-	Supply Current				5.6	mA
SR	Slew Rate	$R_L = 2\text{ K}\Omega$				V/ μs
P_C	Power Consumption	$R_L = \infty$			170	mW
V_N	Input Noise Voltage	$R_S = 1\text{ K}\Omega$ $f = 30\text{ Hz} \sim 30\text{ KHz}$		2.5		μVrms
I_{source}	Source Current		- 20			mA
I_{sink}	Sink Current		20			mA

TYPICAL PERFORMANCE CURVES

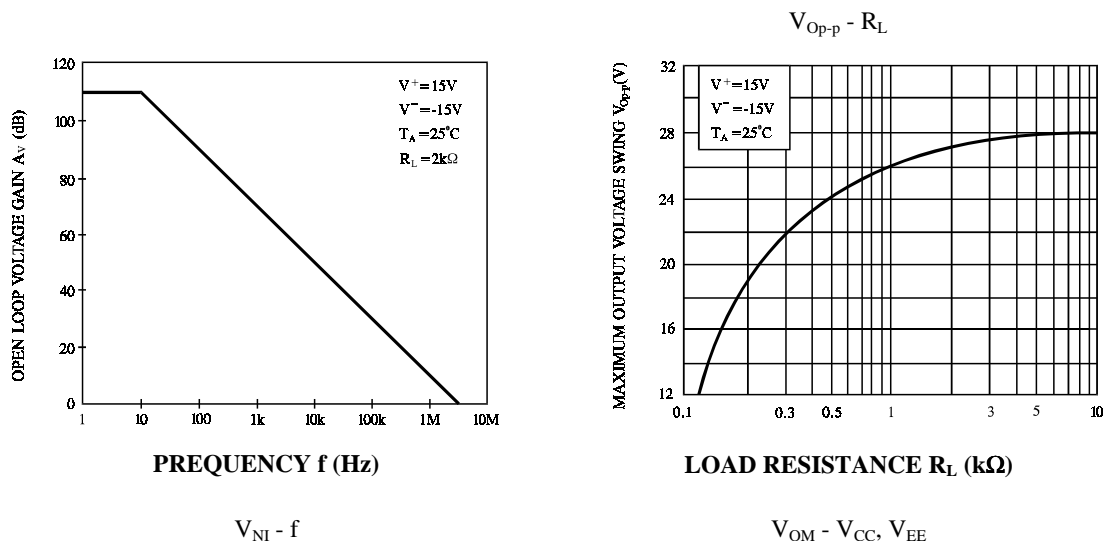

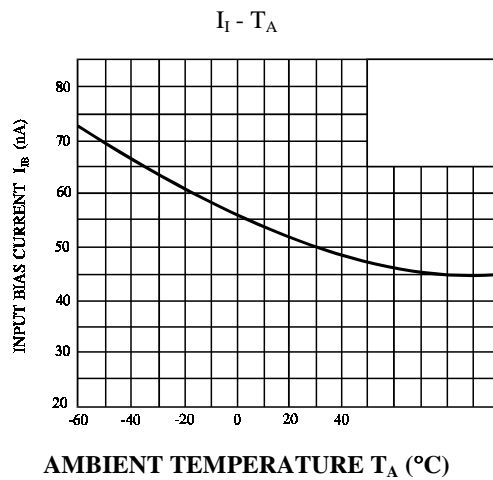
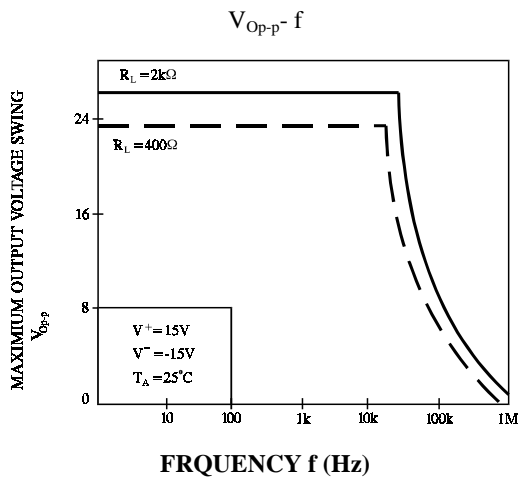
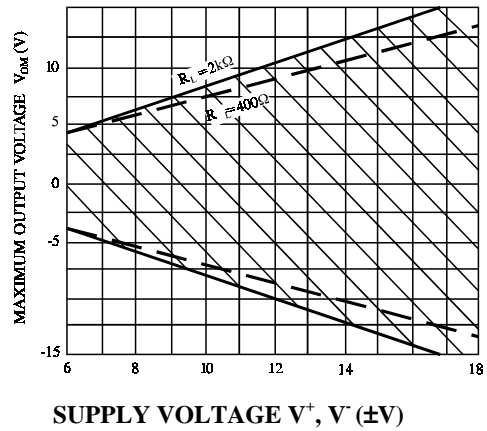
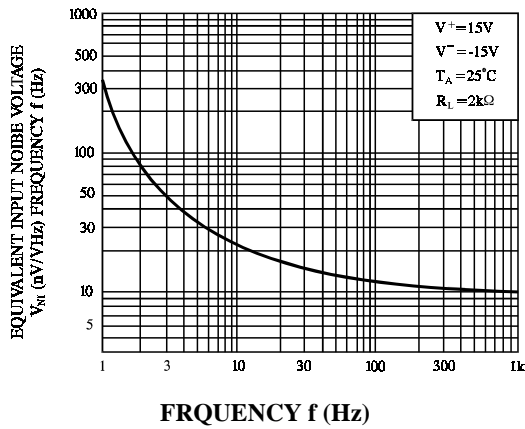

Schematic Diagram (Each Amplifier)

