

IL34119

Low Power Audio Amplifier

The IL34119 is a low power audio amplifier integrated circuit intended (primarily) for telephone applications, such as in speakerphones. It provides differential speaker outputs to maximize output swing at low supply voltages (2.0 volts minimum). Coupling capacitors to the speaker are not required. Open loop gain is 80 dB, and the closed loop gain is set with two external resistors. A Chip Disable pin permits powering down and/or muting the input signal. The IL34119 is available in a standard 8 pin DIP or a surface mount package.

- Wide Operating Supply Voltage Range (2-16 Volts) - Allows Telephone Line Powered Applications
- Low Quiescent Supply Current for Battery Powered Applications
- Chip Disable Input to Power Down the IC
- Low Power Down Quiescent Current
- Drives a Wide Range of Speaker Loads (8-100Ω)
- Output Power Exceeds 250 mW with 32Ω Speaker
- Low Total Harmonic Distortion
- Gain Adjustable from <0 dB to >46 dB for Voice Band
- Requires Few External Components

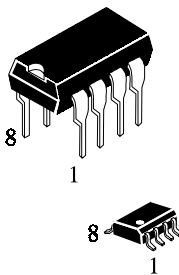

N SUFFIX PLASTIC

D SUFFIX SOIC

ORDERING INFORMATION
 IL34119N Plastic
 IL34119D SOIC
 T_A = -10° to 70° C for all packages

PIN ASSIGNMENT

CD	1 ●	8	VO2
FC2	2	7	GND
FC1	3	6	V _{CC}
V _{IN}	4	5	VO1

SIMPLIFIED BLOCK DIAGRAM

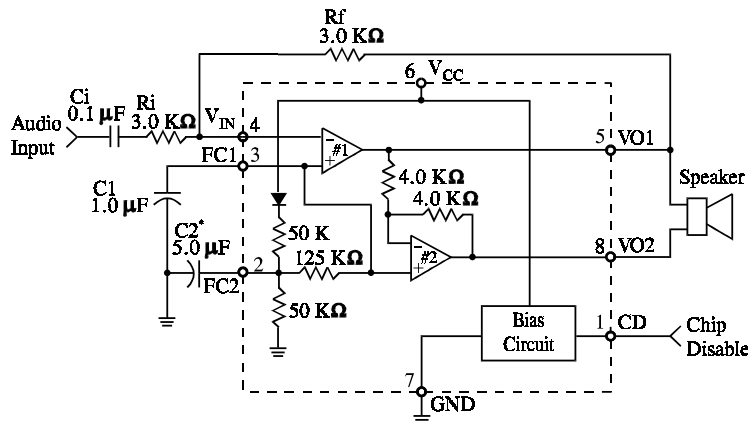

* = Optional
 Differential Gain = $2 \times \frac{R_f}{R_i}$

PIN DESCRIPTION

Pin	Symbol	Description
1	CD	Chip Disable - Digital input. A Logic "0" (<0.8 V) sets normal operation. A Logic "1" (≥ 2.0 V) sets the power down mode. Input impedance is nominally 90 K Ω .
2	FC2	A capacitor at this pin increases power supply rejection, and affects turn-on time. This pin can be left open if the capacitor at FC1 is sufficient.
3	FC1	Analog Ground for the amplifiers. A 1.0 μ F capacitor at this pin (with a 5.0 μ F capacitor at Pin 2) provides 52 dB of power supply rejection. Turn-on time of the circuit is affected by the capacitor on this pin. This pin can be used as an alternate input.
4	V _{IN}	Amplifier input. The input capacitor and resistor set low frequency rolloff and input impedance. The feedback resistor is connected to this pin and VO1.
5	VO1	Amplifier Output #1. The dc level is $\approx (V_{CC} - 0.7 \text{ V})/2$.
6	V _{CC}	DC supply voltage (+2.0 to +16 Volts) is applied to this pin.
7	GND	Ground pin for the entire circuit.
8	VO2	Amplifier Output #2. This signal is equal in amplitude, but 180° out of phase with that at VO1. The dc level is $\approx (V_{CC} - 0.7 \text{ V})/2$.

DESIGN GUIDELINES**GENERAL**

The IL34119 is a low power audio amplifier capable of low voltage operation ($V_{CC} = 2.0$ V minimum) such as that encountered in line-powered speakerphones. The circuit provides a differential output (VO1-VO2) to the speaker to maximize the available voltage swing at low voltages. The differential gain is set by two external resistors. Pins FC1 and FC2 allow controlling the amount of power supply and noise rejection, as well as providing alternate inputs to the amplifiers. The CD pin permits powering down the IC for muting purposes and to conserve power.

AMPLIFIERS

Referring to the block diagram, the internal configuration consists of two identical operational amplifiers. Amplifier #1 has an open-loop gain of ≥ 80 dB (at $f \leq 100$ Hz), and the closed loop gain is set by external resistors R_f and R_i . The amplifier is unity gain stable, and has a unity gain frequency of approximately 1.5 MHz. In order to adequately cover the telephone voice band (300-340 Hz), a maximum closed loop gain of 46 dB is recommended. Amplifier #2 is internally set to a gain of -1.0 (0 dB).

The outputs of both amplifiers are capable of

sourcing and sinking a peak current of 200 mA. The outputs can typically swing to within ≈ 0.4 volts above ground, and to within ≈ 1.3 volts below V_{CC} , at the maximum current. The output dc offset voltage (VO1-VO2) is primarily a function of the feedback resistor (R_f), and secondarily due to the amplifiers' input offset voltages. The input offset voltage of the two amplifiers will generally be similar for a particular IC, and therefore nearly cancel each other at the outputs. Amplifier #1's bias current, however, flows out of V_{IN} (Pin 4) and through R_f , forcing VO1 to shift negative by an amount equal to $[R_f \times I_{IB}]$. VO2 is shifted positive an equal amount. The output offset voltage specified in the Electrical Characteristics is measured with the feedback resistor shown in the Simplified Block Diagram, and therefore takes into account the bias current as well as internal offset voltages of the amplifiers. The bias current is constant with respect to V_{CC} .

FC1 and FC2

Power supply rejection is provided by the capacitors (C1 and C2 in the Simplified Block Diagram) at FC1 and FC2. C2 is somewhat dominant at low frequencies, while C1 is dominant at high frequencies. The required values of C1 and C2 depend on the conditions of each application. A

line powered speakerphone, for example, will require more filtering than a circuit powered by a well regulated power supply. The amount of rejection is a function of the capacitors, and the equivalent impedance looking into FC1 and FC2 (listed in the Electrical Characteristics as R_{FC1} and R_{FC2}).

In addition to providing filtering, C1 and C2 also affect the turn-on time of the circuit at power-up, since the two capacitors must charge up through the internal 50 K Ω and 125 K Ω resistors.

CHIP DISABLE

The Chip Disable (Pin 1) can be used to power down the IC to conserve power, or for muting, or both. When at a Logic “0” (0 to 0.8 Volts), the IL34119 is enabled for normal operation. When Pin 1 is at a Logic “1” (2.0 to V_{CC} Volts), the IC is disabled. If Pin 1 is open, that is equivalent to a Logic “0”, although good design practice dictates that an input should never be left open. Input impedance at Pin 1 is a nominal 90 K Ω . The power supply current (when disabled) is shown in Figure 1.

Muting, defined as the change in differential gain from normal operation to muted operation, is in excess of 70 dB. The turn-off time of the audio output, from the application of the CD signal, is <2.0 μ s, and turn on-time is 12-15 ms. Both times are independent of C1, C2, and V_{CC} .

When the IL34119 is disabled, the voltages at FC1 and FC2 do not change as they are powered from V_{CC} . The outputs, VO1 and VO2, change to a high impedance condition, removing the signal from the speaker. If signals from other sources are to be applied to the outputs (while disabled), they must be within the range of V_{CC} and Ground.

POWER DISSIPATION

Figures 2-4 indicate the device dissipation (within the IC) for various combinations of V_{CC} , R_L ,

and load power. The maximum power which can safely be dissipated within the IL34119 is found from the following equation:

$$P_D = (140^\circ\text{C} - T_A) / \theta_{JA}$$

where T_A is the operating temperature;

and θ_{JA} is the package thermal resistance (100 $^\circ\text{C}/\text{W}$ for the standard DIP package, and 180 $^\circ\text{C}/\text{W}$ for the surface mount package).

The power dissipated within the IL34119, in a given application, is found from the following equation:

$$P_D = (V_{CC} \times I_{CC}) + (I_{RMS} \times V_{CC}) - (R_L \times I_{RMS}^2).$$

where I_{CC} is obtained from Figure 1;

and I_{RMS} is the RMS current at the load;

and R_L is the load resistance.

Figures 2-4, along with Figures 5-7 (distortion curves), and a peak working load current of ± 200 mA, define the operating range for the IL34119. The operating range is further defined in terms of allowable load power in Figure 8 for load of 8.0 Ω , 16 Ω , and 32 Ω . The left (ascending) portion of each of the three curves is defined by the power level at which 10% distortion occurs. The center flat portion of each curve is defined by the maximum output current capability of the IL34119. The right (descending) portion of each curve is defined by the maximum internal power dissipation of the IC at 25 $^\circ\text{C}$. At higher operating be reduced according to the above equations. Operating the device beyond the current and junction temperature limits will degrade long term reliability.

LAYOUT CONSIDERATIONS

Normally a snubber is not needed at the output of the IL34119, unlike many other audio amplifiers. However, the PC board layout, stray capacitances, and the manner in which the speaker wires are configured, may dictate otherwise. Generally the speaker wires should be twisted tightly, and be not more than a few inches in length.

MAXIMUM RATINGS*

Symbol	Parameter	Value	Unit
V_{CC}	Supply Voltage	1.0 to +18	V
I_{OUT}	Maximum Output Current at VO1, VO2	± 250	mA
V_{IN}	Maximum Input Voltage (FC1, FC2, CD, V_{IN})	-1.0 to $V_{CC} + 1.0$	V
V_{VO}	Applied Output Voltage to VO1, VO2 when disabled	-1.0 to $V_{CC} + 1.0$	V
Tstg	Storage Temperature Range	-65 to +150	$^\circ\text{C}$

* Maximum Ratings are those values beyond which damage to the device may occur. Functional operation should be restricted to the Recommended Operating Conditions.

RECOMMENDED OPERATING CONDITIONS

Symbol	Parameter	Min	Max	Unit
V _{CC}	Supply Voltage	2.0	16	V
R _L	Load Impedance	8.0	100	Ω
I _L	Peak Load Current	-	200	mA
AVD	Differential Gain (5.0 KHz bandwidth)	0	46	dB
V _{CD}	Voltage @ CD (Pin 1)	0	V _{CC}	V
T _A	Operating Temperature, All Package Types	-10	+70	°C

This device contains protection circuitry to guard against damage due to high static voltages or electric fields. However, precautions must be taken to avoid applications of any voltage higher than maximum rated voltages to this high-impedance circuit. For proper operation, V_{IN} and V_{OUT} should be constrained to the range GND ≤ (V_{IN} or V_{OUT}) ≤ V_{CC}.

Unused inputs must always be tied to an appropriate logic voltage level (e.g., either GND or V_{CC}). Unused outputs must be left open.

ELECTRICAL CHARACTERISTICS(T_A = -10 to +70°C, V_{CD} = 0 V)

Symbol	Parameter	Test Conditions	Guaranteed Limits		Unit
			Min	Max	
AMPLIFIERS (DC CHARACTERISTICS)					
V _O	Output DC Level (VO1, VO2)	V _{CC} = 3.0 V, R _L = 16Ω R _f = 75 KΩ	0.75	1.75	V
V _{OH}	Output High Level	I _{OUT} = -75 mA, V _{CC} = 2.0 V	0.5	-	V
V _{OL}	Output Low Level	I _{OUT} = 75 mA, 2.0 V ≤ V _{CC} ≤ 16 V	-	0.55	V
ΔV _O	Output DC Offset Voltage (VO1-VO2)	V _{CC} = 6.0 V, R _L = 32Ω R _f = 75 kΩ	-200	200	mV
I _{IB}	Input Bias Current @ VIN	V _{CC} = 6.0 V	-	1600	nA
R _{FC1}	Equivalent Resistance @ FC1	V _{CC} = 6.0 V	100	220	KΩ
R _{FC2}	Equivalent Resistance @ FC2	V _{CC} = 6.0 V	18	40	KΩ
V _{IH}	Minimum High-Level Input Voltage		2.0	-	V
V _{IL}	Maximum Low-Level Input Voltage		-	0.8	V
R _{CD}	Input Resistance	V _{CC} = V _{CD} = 16 V	50*	175*	KΩ

(continued)

ELECTRICAL CHARACTERISTICS($T_A = -10$ to $+70^\circ\text{C}$, $V_{CD} = 0$ V)

Symbol	Parameter	Test Conditions	Guaranteed Limits		Unit
			Min	Max	
AMPLIFIERS (AC CHARACTERISTICS)					
r_i	AC Input Resistance (V_{IN})		22.5	-	M Ω
A_{VOL1}	Open Loop Gain (Amplifier #1)	$f = 100$ Hz, $V_{CC} = 6.0$ V, $V_{FC2} = 2.65$ V	60	-	dB
A_{V2}	Closed Loop Gain (Amplifier #2)	$f = 1.0$ KHz, $V_{CC} = 6.0$ V, $R_L = 32$ Ω	-0.35	+0.35	dB
GBW	Gain Bandwidth Product		1.125	-	MHz
P_{OUT3} P_{OUT12}	Output Power	$V_{CC} = 3.0$ V, $R_L = 16$ Ω , THD $\leq 10\%$, $V_{FC2} = 1.15$ V $V_{CC} = 12.0$ V, $R_L = 100$ Ω , THD $\leq 10\%$, $V_{FC2} = 12$ V	55 400*	-	mW
THD	Total Harmonic Distortion	$V_{CC} = 6.0$ V, $R_L = 32$ Ω , $f = 1.0$ KHz, $P_{OUT} = 125$ mW	-	5.0	%
PSRR	Power Supply Rejection	$V_{CC} = 6.0$ V, $\Delta V_{CC} = 3.0$ V, $C1 = \infty$, $C2 = 0.01$ μF	35	-	dB
GMT	Muting	$V_{CC} = 6.0$ V, $f = 1.0$ kHz, $CD = 2.0$ V	50	-	dB
POWER SUPPLY					
I_{CC1} I_{CC2}	Maximum Power Supply Current	$V_{CC} = 3.0$ V, $R_L = \infty$, $CD = 0.8$ V $V_{CC} = 3.0$ V, $R_L = \infty$, $CD = 2.0$ V	- -	5.0 125	mA μA

* @25°C

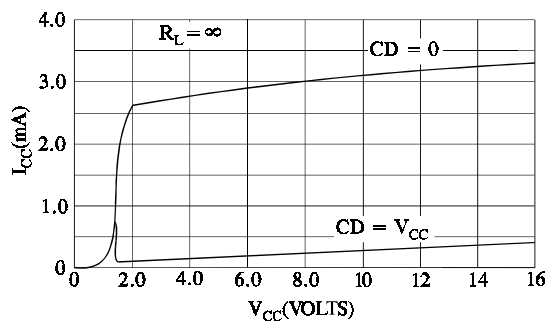

Figure 1. POWER SUPPLY CURRENT

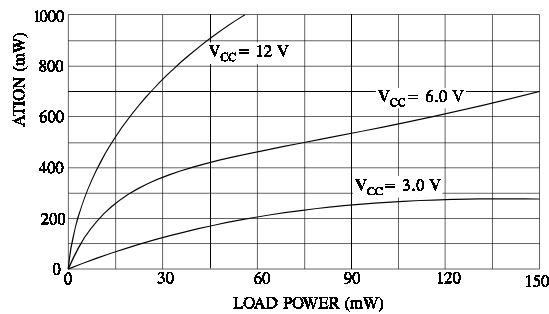

Figure 2. DEVICE DISSIPATION
8.0 Ω LOAD

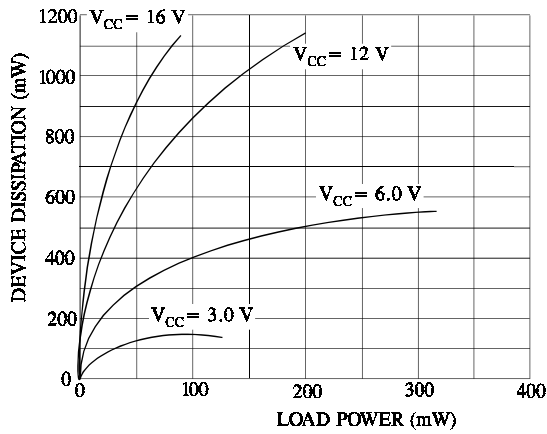

Figure 3. DEVICE DISSIPATION
16 Ω LOAD

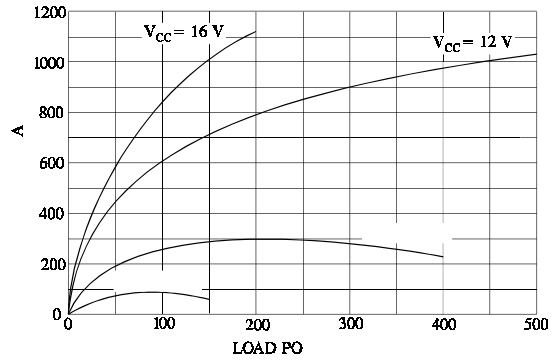

Figure 4. DEVICE DISSIPATION
32 Ω LOAD

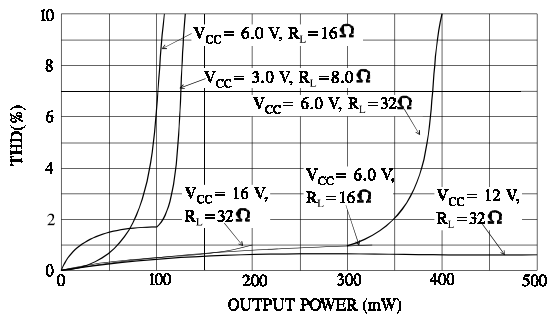

Figure 5. DISTORTION versus POWER
f = 1.0 kHz, AVD = 34 dB

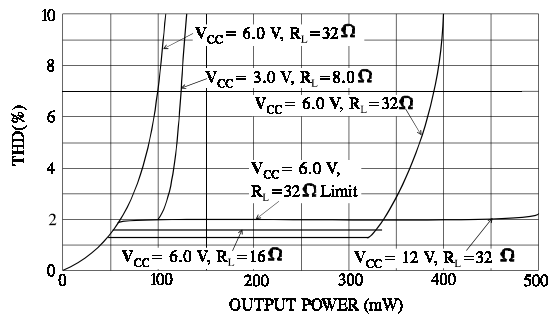

Figure 6. DISTORTION versus POWER
f = 3.0 kHz, AVD = 34 dB

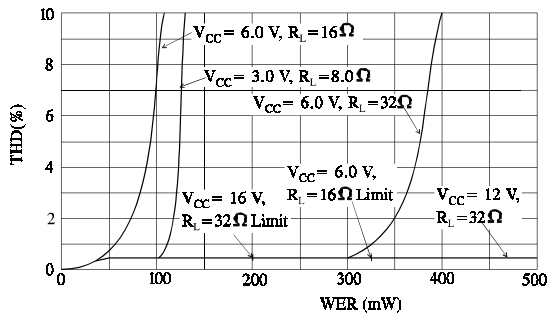

Figure 7. DISTORTION versus POWER
f = 1, 3.0 kHz, AVD = 12 dB

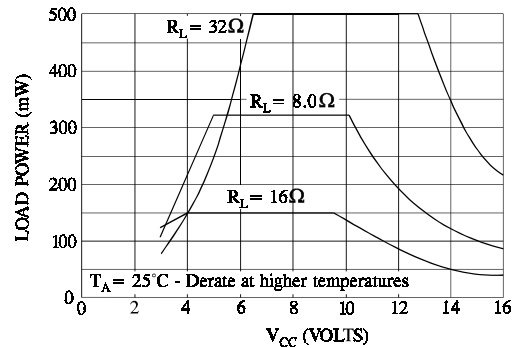

Figure 8. MAXIMUM ALLOWABLE LOAD
POWER