

**Document Title**

**512Kx36 & 1Mx18-Bit Synchronous Burst SRAM**

**Revision History**

<u>Rev. No.</u>	<u>History</u>	<u>Draft Date</u>	<u>Remark</u>
0.0	1. Initial draft	Feb. 23. 2001	Preliminary
0.1	1. Add JTAG Scan Order	May. 10. 2001	Preliminary
0.2	1. Add x32 org and industrial temperature . 2. Add 165FBGA package	Aug. 30. 2001	Preliminary
1.0	1. Final spec release	May. 10. 2002	Final
1.1	1. Delete 119BGA package. 2. Correct the Ball Size of 165 FBGA.	April 04. 2003	Final
2.0	1. Delete x32 Org. 2. Delete 165FBGA package. 3. Delete the 6.5 ns speed bin.	Nov. 17, 2003	Final

**16Mb SB/SPB Synchronous SRAM Ordering Information**

Org.	Part Number	Mode	VDD	Speed SB ; Access Time(ns) SPB ; Cycle Time(MHz)	PKG	Temp	
1Mx18	K7B161825A-QC(I)75/85	SB	3.3	7.5/8.5ns	Q : 100TQFP	C ; Commercial Temp.Range	
	K7A161800A-QC(I)25/16/14	SPB(2E1D)	3.3	250/167/138MHz			
	K7A161801A-QC(I)20/16	SPB(2E2D)	3.3	200/167MHz			
512Kx36	K7B163625A-QC(I)75/85	SB	3.3	7.5/8.5ns		Q : 100TQFP	I ; Industrial Temp.Range
	K7A163600A-QC(I)25/16/14	SPB(2E1D)	3.3	250/167/138MHz			
	K7A163601A-QC(I)20/16	SPB(2E2D)	3.3	200/167MHz			

**512Kx36 & 1Mx18-Bit Synchronous Burst SRAM**

**FEATURES**

- Synchronous Operation.
- On-Chip Address Counter.
- Self-Timed Write Cycle.
- On-Chip Address and Control Registers.
- 3.3V+0.165V/-0.165V Power Supply.
- I/O Supply Voltage 3.3V+0.165V/-0.165V for 3.3V I/O or 2.5V+0.4V/-0.125V for 2.5V I/O
- 5V Tolerant Inputs Except I/O Pins.
- Byte Writable Function.
- Global Write Enable Controls a full bus-width write.
- Power Down State via ZZ Signal.
- LBO Pin allows a choice of either a interleaved burst or a linear burst.
- Three Chip Enables for simple depth expansion with No Data Contention only for TQFP.
- Asynchronous Output Enable Control.
- ADSP, ADSC, ADV Burst Control Pins.
- TTL-Level Three-State Output.
- 100-TQFP-1420A
- Operating in commercial and industrial temperature range.

**GENERAL DESCRIPTION**

The K7B163625A and K7B161825A are 18,874,368-bit Synchronous Static Random Access Memory designed for high performance second level cache of Pentium and Power PC based System.

It is organized as 512K(1M) words of 36(32/18) bits and integrates address and control registers, a 2-bit burst address counter and added some new functions for high performance cache RAM applications;  $\overline{GW}$ ,  $\overline{BW}$ ,  $\overline{LBO}$ , ZZ. Write cycles are internally self-timed and synchronous.

Full bus-width write is done by  $\overline{GW}$ , and each byte write is performed by the combination of  $\overline{WEx}$  and  $\overline{BW}$  when  $\overline{GW}$  is high. And with  $\overline{CS1}$  high,  $\overline{ADSP}$  is blocked to control signals.

Burst cycle can be initiated with either the address status processor(ADSP) or address status cache controller(ADSC) inputs. Subsequent burst addresses are generated internally in the system's burst sequence and are controlled by the burst address advance(ADV) input.

$\overline{LBO}$  pin is DC operated and determines burst sequence(linear or interleaved).

ZZ pin controls Power Down State and reduces Stand-by current regardless of CLK.

The K7B163625A and K7B161825A are fabricated using SAMSUNG's high performance CMOS technology and is available in a 100pin TQFP package. Multiple power and ground pins are utilized to minimize ground bounce.

**FAST ACCESS TIMES**

PARAMETER	Symbol	-75	-85	Unit
Cycle Time	t <sub>CYC</sub>	8.5	10	ns
Clock Access Time	t <sub>CD</sub>	7.5	8.5	ns
Output Enable Access Time	t <sub>OE</sub>	3.5	4.0	ns

**LOGIC BLOCK DIAGRAM**

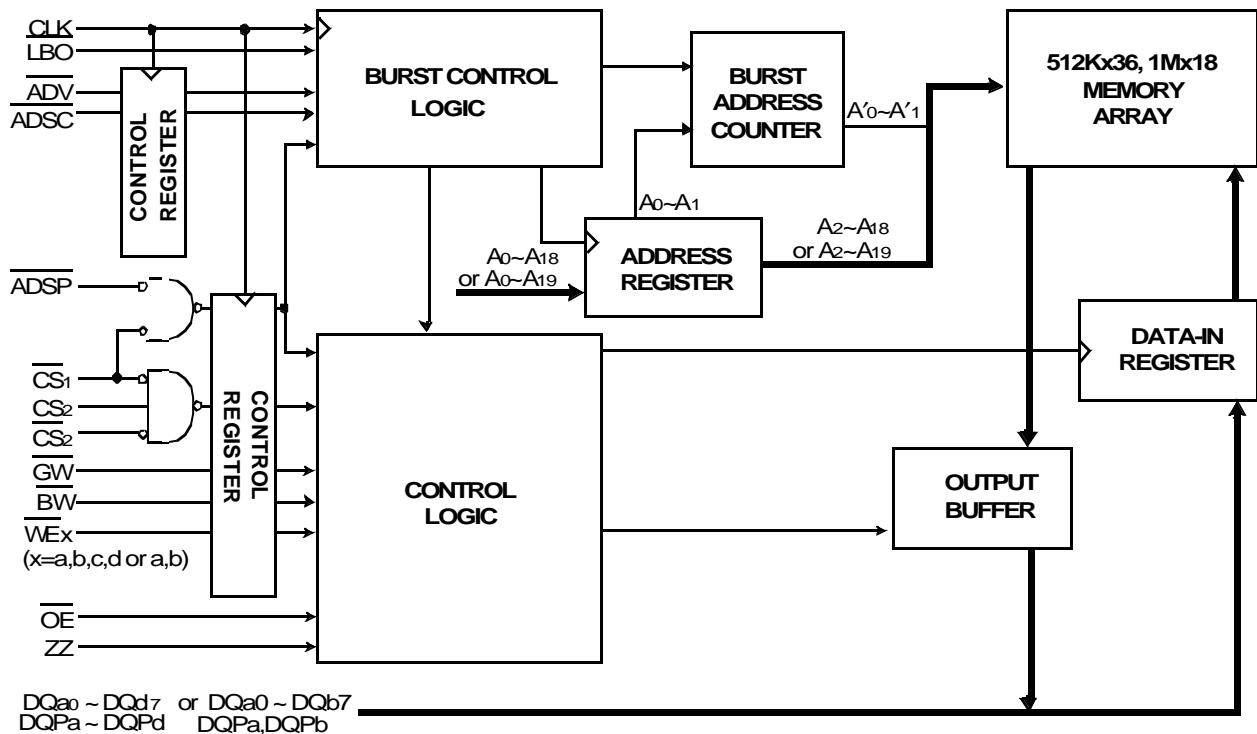

DQa<sub>0</sub> ~ DQd<sub>7</sub> or DQa<sub>0</sub> ~ DQb<sub>7</sub>  
DQPa ~ DQPd DQPa, DQPb

**K7B163625A  
K7B161825A**

**512Kx36 & 1Mx18 Synchronous SRAM**

**PIN CONFIGURATION(TOP VIEW)**

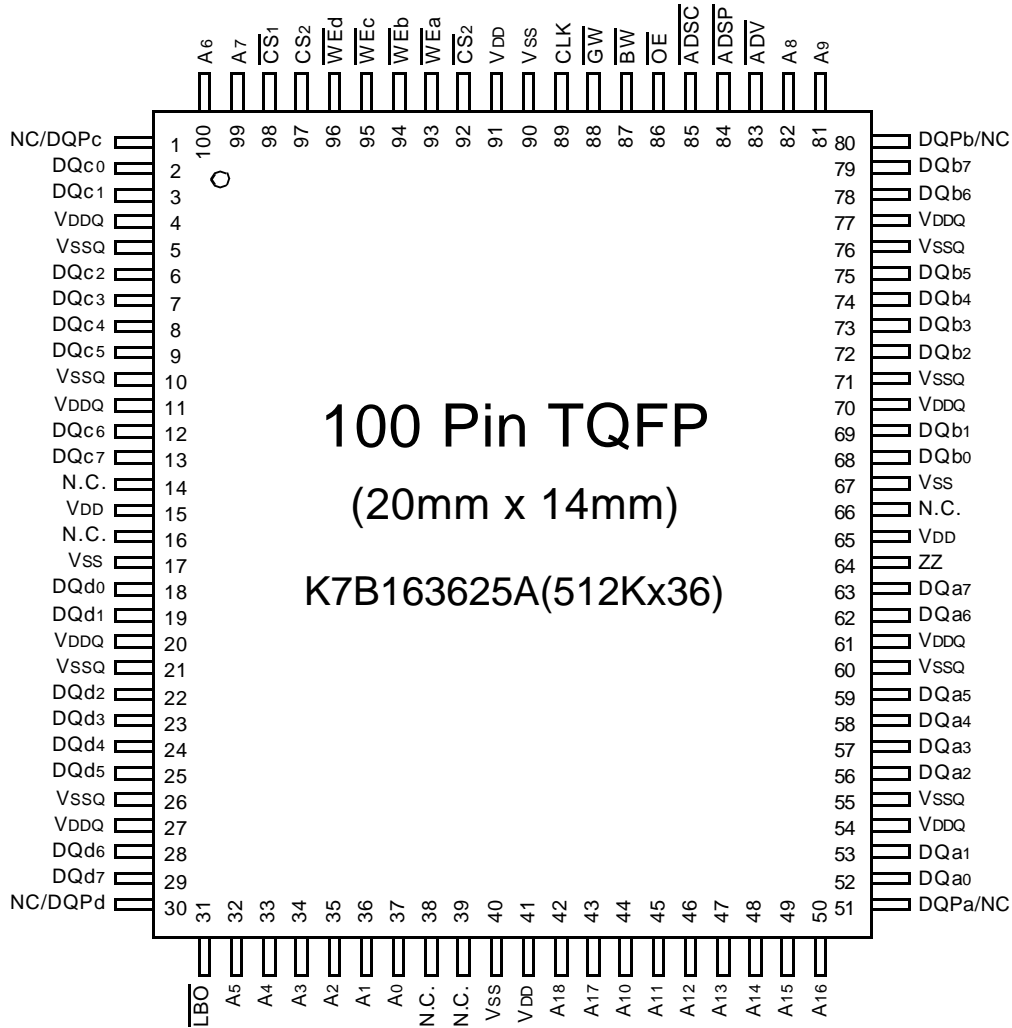

**PIN NAME**

SYMBOL	PIN NAME	TQFP PIN NO.	SYMBOL	PIN NAME	TQFP PIN NO.
A0 - A18	Address Inputs	32,33,34,35,36,37,42 43,44,45,46,47,48,49 50,81,82,99,100	VDD	Power Supply(+3.3V)	15,41,65,91
			VSS	Ground	17,40,67,90
<u>ADV</u>	Burst Address Advance	83	N.C.	No Connect	14,16,38,39,66
<u>ADSP</u>	Address Status Processor	84	DQa0~a7	Data Inputs/Outputs	52,53,56,57,58,59,62,63
<u>ADSC</u>	Address Status Controller	85	DQb0~b7		68,69,72,73,74,75,78,79
<u>CLK</u>	Clock	89	DQc0~c7		2,3,6,7,8,9,12,13
<u>CS1</u>	Chip Select	98	DQd0~d7		18,19,22,23,24,25,28,29
<u>CS2</u>	Chip Select	97	DQPa~Pd		51,80,1,30
<u>CS2</u>	Chip Select	92	or NC		
<u>WE</u> x(x=a,b,c,d)	Byte Write Inputs	93,94,95,96	VDDQ	Output Power Supply (2.5V or 3.3V)	4,11,20,27,54,61,70,77
<u>OE</u>	Output Enable	86	VSSQ	Output Ground	5,10,21,26,55,60,71,76
<u>GW</u>	Global Write Enable	88			
<u>BW</u>	Byte Write Enable	87			
<u>ZZ</u>	Power Down Input	64			
<u>LBO</u>	Burst Mode Control	31			

Notes : 1. A<sub>0</sub> and A<sub>1</sub> are the two least significant bits(LSB) of the address field and set the internal burst counter if burst is desired.

**K7B163625A  
K7B161825A**

**512Kx36 & 1Mx18 Synchronous SRAM**

**PIN CONFIGURATION(TOP VIEW)**

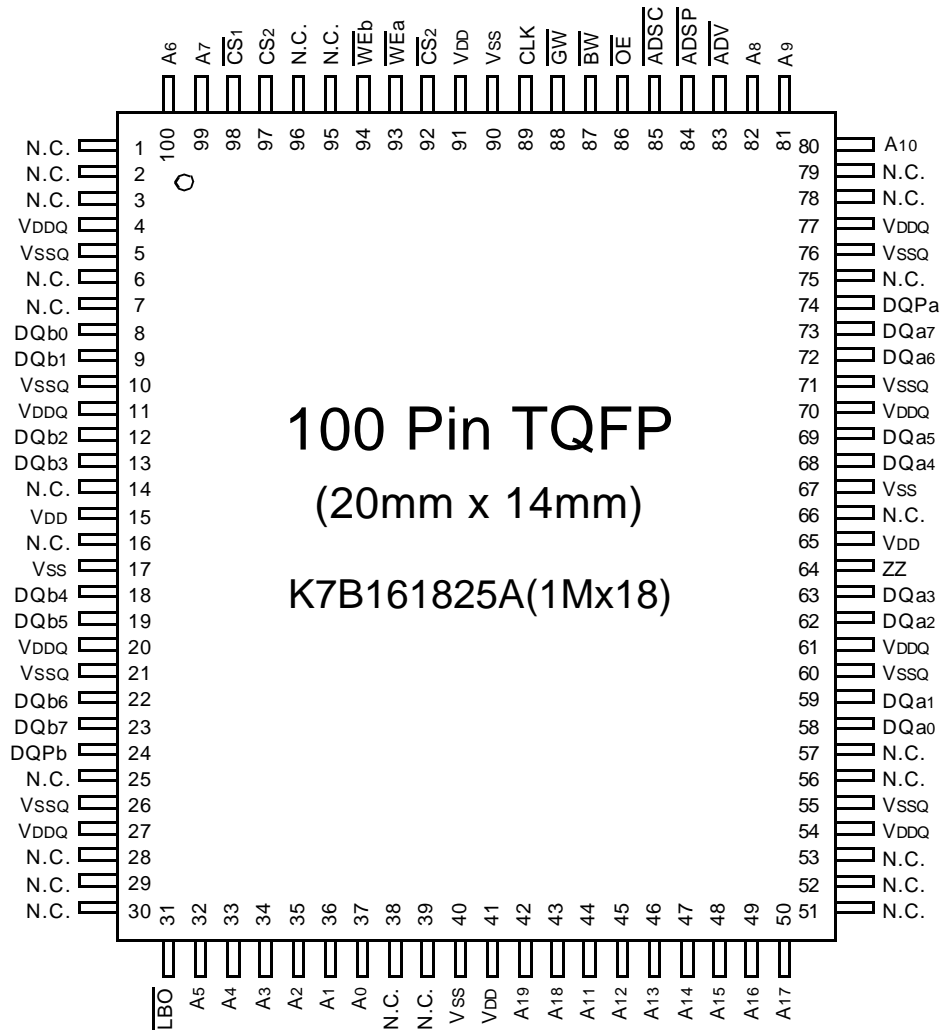

**PIN NAME**

SYMBOL	PIN NAME	TQFP PIN NO.	SYMBOL	PIN NAME	TQFP PIN NO.
A0 - A19	Address Inputs	32,33,34,35,36,37,42 43,44,45,46,47,48,49 50 80,81,82,99,100	VDD	Power Supply(+3.3V)	15,41,65,91
			Vss	Ground	17,40,67,90
			N.C.	No Connect	1,2,3,6,7,14,16,25,28,29, 30,38,39,51,52,53,56,57, 66,75,78,79,95,96
<u>ADV</u>	Burst Address Advance	83			
<u>ADSP</u>	Address Status Processor	84	DQa0 ~ a7	Data Inputs/Outputs	58,59,62,63,68,69,72,73
<u>ADSC</u>	Address Status Controller	85	DQb0 ~ b7		8,9,12,13,18,19,22,23
CLK	Clock	89	DQPa, Pb		74,24
<u>CS1</u>	Chip Select	98	VDDQ	Output Power Supply (2.5V or 3.3V)	4,11,20,27,54,61,70,77
<u>CS2</u>	Chip Select	97	VssQ	Output Ground	5,10,21,26,55,60,71,76
<u>CS2</u>	Chip Select	92			
<u>WEx(x=a,b)</u>	Byte Write Inputs	93,94			
<u>OE</u>	Output Enable	86			
<u>GW</u>	Global Write Enable	88			
<u>BW</u>	Byte Write Enable	87			
<u>ZZ</u>	Power Down Input	64			
<u>LBO</u>	Burst Mode Control	31			

Notes : 1. A<sub>0</sub> and A<sub>1</sub> are the two least significant bits(LSB) of the address field and set the internal burst counter if burst is desired.

**FUNCTION DESCRIPTION**

The K7B163625A and K7B161825A are synchronous SRAM designed to support the burst address accessing sequence of the Power PC based microprocessor. All inputs (with the exception of  $\overline{OE}$ ,  $\overline{LBO}$  and  $\overline{ZZ}$ ) are sampled on rising clock edges. The start and duration of the burst access is controlled by  $\overline{ADSC}$ ,  $\overline{ADSP}$  and  $\overline{ADV}$  and chip select pins.

The accesses are enabled with the chip select signals and output enabled signals. Wait states are inserted into the access with  $\overline{ADV}$ .

When  $\overline{ZZ}$  is pulled high, the SRAM will enter a Power Down State. At this time, internal state of the SRAM is preserved. When  $\overline{ZZ}$  returns to low, the SRAM normally operates after 2cycles of wake up time.  $\overline{ZZ}$  pin is pulled down internally.

Read cycles are initiated with  $\overline{ADSP}$ (or  $\overline{ADSC}$ ) using the new external address clocked into the on-chip address register when both  $\overline{GW}$  and  $\overline{BW}$  are high or when  $\overline{BW}$  is low and  $\overline{WEa}$ ,  $\overline{WEb}$ ,  $\overline{WEc}$ , and  $\overline{WEd}$  are high. When  $\overline{ADSP}$  is sampled low, the chip selects are sampled active, and the output buffer is enabled with  $\overline{OE}$ . the data of cell array accessed by the current address are projected to the output pins.

Write cycles are also initiated with  $\overline{ADSP}$ (or  $\overline{ADSC}$ ) and are differentiated into two kinds of operations; All byte write operation and individual byte write operation.

All byte write occurs by enabling  $\overline{GW}$ (independent of  $\overline{BW}$  and  $\overline{WEx}$ ), and individual byte write is performed only when  $\overline{GW}$  is high and  $\overline{BW}$  is low. In K7B163625M, a 512Kx36 organization,  $\overline{WEa}$  controls DQa0 ~ DQa7 and DQPa,  $\overline{WEb}$  controls DQb0 ~ DQb7 and DQPb,  $\overline{WEc}$  controls DQc0 ~ DQc7 and DQPc and  $\overline{WEd}$  controls DQd0 ~ DQd7 and DQPd.

$\overline{CS1}$  is used to enable the device and conditions internal use of  $\overline{ADSP}$  and is sampled only when a new external address is loaded.

$\overline{ADV}$  is ignored at the clock edge when  $\overline{ADSP}$  is asserted, but can be sampled on the subsequent clock edges. The address increases internally for the next access of the burst when  $\overline{ADV}$  is sampled low.

Addresses are generated for the burst access as shown below, The starting point of the burst sequence is provided by the external address. The burst address counter wraps around to its initial state upon completion. The burst sequence is determined by the state of the  $\overline{LBO}$  pin. When this pin is Low, linear burst sequence is selected. And this pin is High, Interleaved burst sequence is selected.

**BURST SEQUENCE TABLE**

(Interleaved Burst)

$\overline{LBO}$ PIN	HIGH	Case 1		Case 2		Case 3		Case 4	
		A1	A0	A1	A0	A1	A0	A1	A0
	First Address	0	0	0	1	1	0	1	1
	↓	0	1	0	0	1	1	1	0
	↓	1	0	1	1	0	0	0	1
	Fourth Address	1	1	1	0	0	1	0	0

(Linear Burst)

$\overline{LBO}$ PIN	LOW	Case 1		Case 2		Case 3		Case 4	
		A1	A0	A1	A0	A1	A0	A1	A0
	First Address	0	0	0	1	1	0	1	1
	↓	0	1	1	0	1	1	0	0
	↓	1	0	1	1	0	0	0	1
	Fourth Address	1	1	0	0	0	1	1	0

**Note :** 1.  $\overline{LBO}$  pin must be tied to High or Low, and Floating State must not be allowed.

**TRUTH TABLES**

**SYNCHRONOUS TRUTH TABLE**

CS <sub>1</sub>	CS <sub>2</sub>	CS <sub>2</sub>	ADSP	ADSC	ADV	WRITE	CLK	ADDRESS ACCESSED	OPERATION
H	X	X	X	L	X	X	↑	N/A	Not Selected
L	L	X	L	X	X	X	↑	N/A	Not Selected
L	X	H	L	X	X	X	↑	N/A	Not Selected
L	L	X	X	L	X	X	↑	N/A	Not Selected
L	X	H	X	L	X	X	↑	N/A	Not Selected
L	H	L	L	X	X	X	↑	External Address	Begin Burst Read Cycle
L	H	L	H	L	X	L	↑	External Address	Begin Burst Write Cycle
L	H	L	H	L	X	H	↑	External Address	Begin Burst Read Cycle
X	X	X	H	H	L	H	↑	Next Address	Continue Burst Read Cycle
H	X	X	X	H	L	H	↑	Next Address	Continue Burst Read Cycle
X	X	X	H	H	L	L	↑	Next Address	Continue Burst Write Cycle
H	X	X	X	H	L	L	↑	Next Address	Continue Burst Write Cycle
X	X	X	H	H	H	H	↑	Current Address	Suspend Burst Read Cycle
H	X	X	X	H	H	H	↑	Current Address	Suspend Burst Read Cycle
X	X	X	H	H	H	L	↑	Current Address	Suspend Burst Write Cycle
H	X	X	X	H	H	L	↑	Current Address	Suspend Burst Write Cycle

- Notes :** 1. X means "Don't Care".  
 2. The rising edge of clock is symbolized by ↑.  
 3. WRITE = L means Write operation in WRITE TRUTH TABLE.  
 WRITE = H means Read operation in WRITE TRUTH TABLE.  
 4. Operation finally depends on status of asynchronous input pins(ZZ and OE).

**WRITE TRUTH TABLE (x36)**

GW	BW	WEa	WEb	WEc	WEd	OPERATION
H	H	X	X	X	X	READ
H	L	H	H	H	H	READ
H	L	L	H	H	H	WRITE BYTE a
H	L	H	L	H	H	WRITE BYTE b
H	L	H	H	L	L	WRITE BYTE c and d
H	L	L	L	L	L	WRITE ALL BYTEs
L	X	X	X	X	X	WRITE ALL BYTEs

- Notes :** 1. X means "Don't Care".  
 2. All inputs in this table must meet setup and hold time around the rising edge of CLK(↑).

**WRITE TRUTH TABLE (x18)**

GW	BW	WEa	WEb	OPERATION
H	H	X	X	READ
H	L	H	H	READ
H	L	L	H	WRITE BYTE a
H	L	H	L	WRITE BYTE b
H	L	L	L	WRITE ALL BYTEs
L	X	X	X	WRITE ALL BYTEs

- Notes :** 1. X means "Don't Care".  
 2. All inputs in this table must meet setup and hold time around the rising edge of CLK(↑).

**ASYNCHRONOUS TRUTH TABLE**

Operation	ZZ	$\overline{OE}$	I/O STATUS
Sleep Mode	H	X	High-Z
Read	L	L	DQ
	L	H	High-Z
Write	L	X	Din, High-Z
Deselected	L	X	High-Z

**Notes**

1. X means "Don't Care".
2. ZZ pin is pulled down internally
3. For write cycles that following read cycles, the output buffers must be disabled with  $\overline{OE}$ , otherwise data bus contention will occur.
4. Sleep Mode means power down state of which stand-by current does not depend on cycle time.
5. Deselected means power down state of which stand-by current depends on cycle time.

**ABSOLUTE MAXIMUM RATINGS\***

PARAMETER	SYMBOL	RATING	UNIT	
Voltage on VDD Supply Relative to VSS	VDD	-0.3 to 4.6	V	
Voltage on VDDQ Supply Relative to VSS	VDDQ	VDD	V	
Voltage on Input Pin Relative to VSS	VIN	-0.3 to VDD+0.3	V	
Voltage on I/O Pin Relative to VSS	VIO	-0.3 to VDDQ+0.3	V	
Power Dissipation	Pd	1.6	W	
Storage Temperature	TSTG	-65 to 150	°C	
Operating Temperature	Commercial	TOPR	0 to 70	°C
	Industrial	TOPR	-40 to 85	°C
Storage Temperature Range Under Bias	TBIAS	-10 to 85	°C	

\*Note : Stresses greater than those listed under "Absolute Maximum Ratings" may cause permanent damage to the device. This is a stress rating only and functional operation of the device at these or any other conditions above those indicated in the operating sections of this specification is not implied. Exposure to absolute maximum rating conditions for extended periods may affect reliability.

**OPERATING CONDITIONS at 3.3V I/O(0°C ≤ TA ≤ 70°C)**

PARAMETER	SYMBOL	MIN	Typ.	MAX	UNIT
Supply Voltage	VDD	3.135	3.3	3.465	V
	VDDQ	3.135	3.3	3.465	V
Ground	VSS	0	0	0	V

\* The above parameters are also guaranteed at industrial temperature range.

**OPERATING CONDITIONS at 2.5V I/O(0°C ≤ TA ≤ 70°C)**

PARAMETER	SYMBOL	MIN	Typ.	MAX	UNIT
Supply Voltage	VDD	3.135	3.3	3.465	V
	VDDQ	2.375	2.5	2.9	V
Ground	VSS	0	0	0	V

\* The above parameters are also guaranteed at industrial temperature range.

**CAPACITANCE\*(TA=25°C, f=1MHz)**

PARAMETER	SYMBOL	TEST CONDITION	MIN	MAX	UNIT
Input Capacitance	CIN	VIN=0V	-	5	pF
Output Capacitance	COU	VOUT=0V	-	7	pF

\*Note : Sampled not 100% tested.



**DC ELECTRICAL CHARACTERISTICS** ( $V_{DD}=3.3V+0.165V/-0.165V$ ,  $T_A=0^{\circ}C$  to  $+70^{\circ}C$ )

Parameter	Symbol	Test Conditions	Min	Max	Unit	Notes	
Input Leakage Current(except ZZ)	IIL	$V_{DD}=\text{Max}$ ; $V_{IN}=V_{SS}$ to $V_{DD}$	-2	+2	$\mu A$		
Output Leakage Current	IOL	Output Disabled, $V_{out}=V_{SS}$ to $V_{DDQ}$	-2	+2	$\mu A$		
Operating Current	ICC	Device Selected, $I_{OUT}=0mA$ , $ZZ \leq V_{IL}$ , Cycle Time $\geq t_{CYC}$ Min	-75	-	250	mA	1,2
			-85	-	230		
Standby Current	ISB	Device deselected, $I_{OUT}=0mA$ , $ZZ \leq V_{IL}$ , $f=\text{Max}$ , All Inputs $\leq 0.2V$ or $\geq V_{DD}-0.2V$	-75	-	90	mA	
			-85	-	80		
	ISB1	Device deselected, $I_{OUT}=0mA$ , $ZZ \leq 0.2V$ , $f=0$ , All Inputs=fixed ( $V_{DD}-0.2V$ or $\geq V_{DD}$ )	-	-	70	mA	
ISB2	Device deselected, $I_{OUT}=0mA$ , $ZZ \geq V_{DD}-0.2V$ , $f=\text{Max}$ , All Inputs $\leq V_{IL}$ or $\geq V_{IH}$	-	-	60	mA		
Output Low Voltage(3.3V I/O)	VOL	$I_{OL}=8.0mA$	-	0.4	V		
Output High Voltage(3.3V I/O)	VOH	$I_{OH}=-4.0mA$	2.4	-	V		
Output Low Voltage(2.5V I/O)	VOL	$I_{OL}=1.0mA$	-	0.4	V		
Output High Voltage(2.5V I/O)	VOH	$I_{OH}=-1.0mA$	2.0	-	V		
Input Low Voltage(3.3V I/O)	VIL		-0.3*	0.8	V		
Input High Voltage(3.3V I/O)	VIH		2.0	$V_{DD}+0.3^{**}$	V	3	
Input Low Voltage(2.5V I/O)	VIL		-0.3*	0.7	V		
Input High Voltage(2.5V I/O)	VIH		1.7	$V_{DD}+0.3^{**}$	V	3	

- Notes :** 1. The above parameters are also guaranteed at industrial temperature range.  
2. Reference AC Operating Conditions and Characteristics for input and timing.  
3. Data states are all zero.  
4. In Case of I/O Pins, the Max.  $V_{IH}=V_{DDQ}+0.3V$

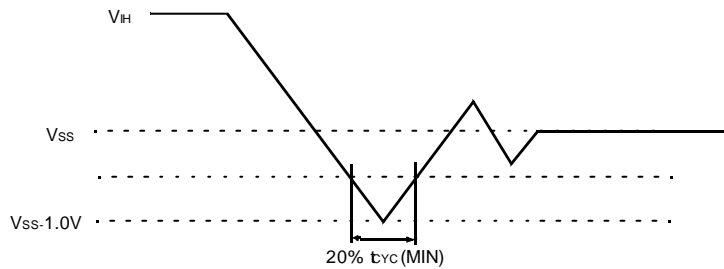

**TEST CONDITIONS**

( $V_{DD}=3.3V+0.165V/-0.165V$ ,  $V_{DDQ}=3.3V+0.165V/-0.165V$  or  $V_{DD}=3.3V+0.165V/-0.165V$ ,  $V_{DDQ}=2.5V+0.4V/-0.125V$ ,  $T_A=0$  to  $70^{\circ}C$ )

PARAMETER	VALUE
Input Pulse Level(for 3.3V I/O)	0 to 3.0V
Input Pulse Level(for 2.5V I/O)	0 to 2.5V
Input Rise and Fall Time(Measured at 20% to 80% for 3.3V I/O)	1.0V/ns
Input Rise and Fall Time(Measured at 20% to 80% for 2.5V I/O)	1.0V/ns
Input and Output Timing Reference Levels for 3.3V I/O	1.5V
Input and Output Timing Reference Levels for 2.5V I/O	$V_{DDQ}/2$
Output Load	See Fig. 1

\* The above parameters are also guaranteed at industrial temperature range.

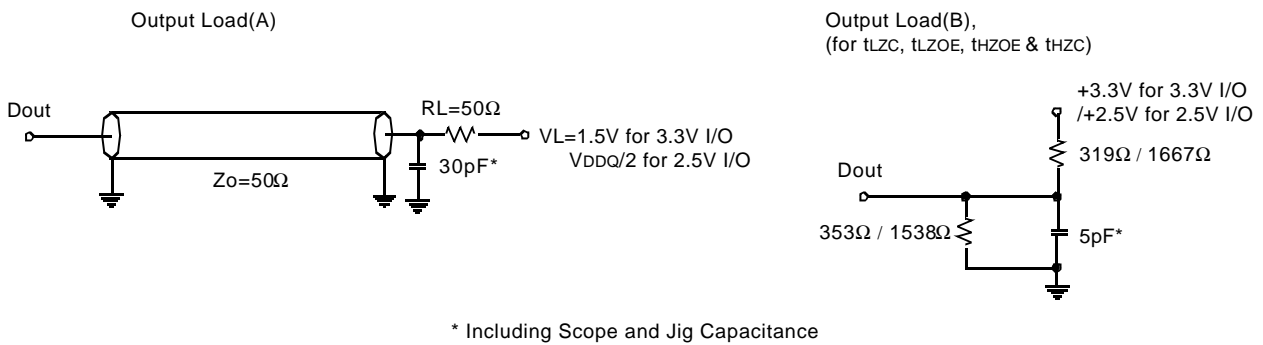

Fig. 1

**AC TIMING CHARACTERISTICS**( $V_{DD}=3.3V+0.165V/-0.165V$ ,  $T_A=0^{\circ}C$  to  $+70^{\circ}C$ )

PARAMETER	SYMBOL	-75		-85		UNIT
		MIN	MAX	MIN	MAX	
Cycle Time	tCYC	8.5	-	10	-	ns
Clock Access Time	tCD	-	7.5	-	8.5	ns
Output Enable to Data Valid	tOE	-	3.5	-	4.0	ns
Clock High to Output Low-Z	tLZC	2.5	-	2.5	-	ns
Output Hold from Clock High	tOH	2.5	-	2.5	-	ns
Output Enable Low to Output Low-Z	tLZOE	0	-	0	-	ns
Output Enable High to Output High-Z	tHZOE	-	3.5	-	4.0	ns
Clock High to Output High-Z	tHZC	-	4.0	-	5.0	ns
Clock High Pulse Width	tCH	2.5	-	3.0	-	ns
Clock Low Pulse Width	tCL	2.5	-	3.0	-	ns
Address Setup to Clock High	tAS	2.0	-	2.0	-	ns
Address Status Setup to Clock High	tSS	2.0	-	2.0	-	ns
Data Setup to Clock High	tDS	2.0	-	2.0	-	ns
Write Setup to Clock High ( $\overline{GW}$ , $\overline{BW}$ , $\overline{WEX}$ )	tWS	2.0	-	2.0	-	ns
Address Advance Setup to Clock High	tADVS	2.0	-	2.0	-	ns
Chip Select Setup to Clock High	tCSS	2.0	-	2.0	-	ns
Address Hold from Clock High	tAH	0.5	-	0.5	-	ns
Address Status Hold from Clock High	tSH	0.5	-	0.5	-	ns
Data Hold from Clock High	tDH	0.5	-	0.5	-	ns
Write Hold from Clock High ( $\overline{GW}$ , $\overline{BW}$ , $\overline{WEX}$ )	tWH	0.5	-	0.5	-	ns
Address Advance Hold from Clock High	tADVH	0.5	-	0.5	-	ns
Chip Select Hold from Clock High	tCSH	0.5	-	0.5	-	ns
ZZ High to Power Down	tPDS	2	-	2	-	cycle
ZZ Low to Power Up	tPUS	2	-	2	-	cycle

- Notes :**
1. The above parameters are also guaranteed at industrial temperature range.
  2. All address inputs must meet the specified setup and hold times for all rising clock edges whenever  $\overline{ADSC}$  and/or  $\overline{ADSP}$  is sampled low and  $\overline{CS}$  is sampled low. All other synchronous inputs must meet the specified setup and hold times whenever this device is chip selected.
  3. Both chip selects must be active whenever  $\overline{ADSC}$  or  $\overline{ADSP}$  is sampled low in order for the this device to remain enabled.
  4.  $\overline{ADSC}$  or  $\overline{ADSP}$  must not be asserted for at least 2 Clock after leaving ZZ state.

TIMING WAVEFORM OF READ CYCLE

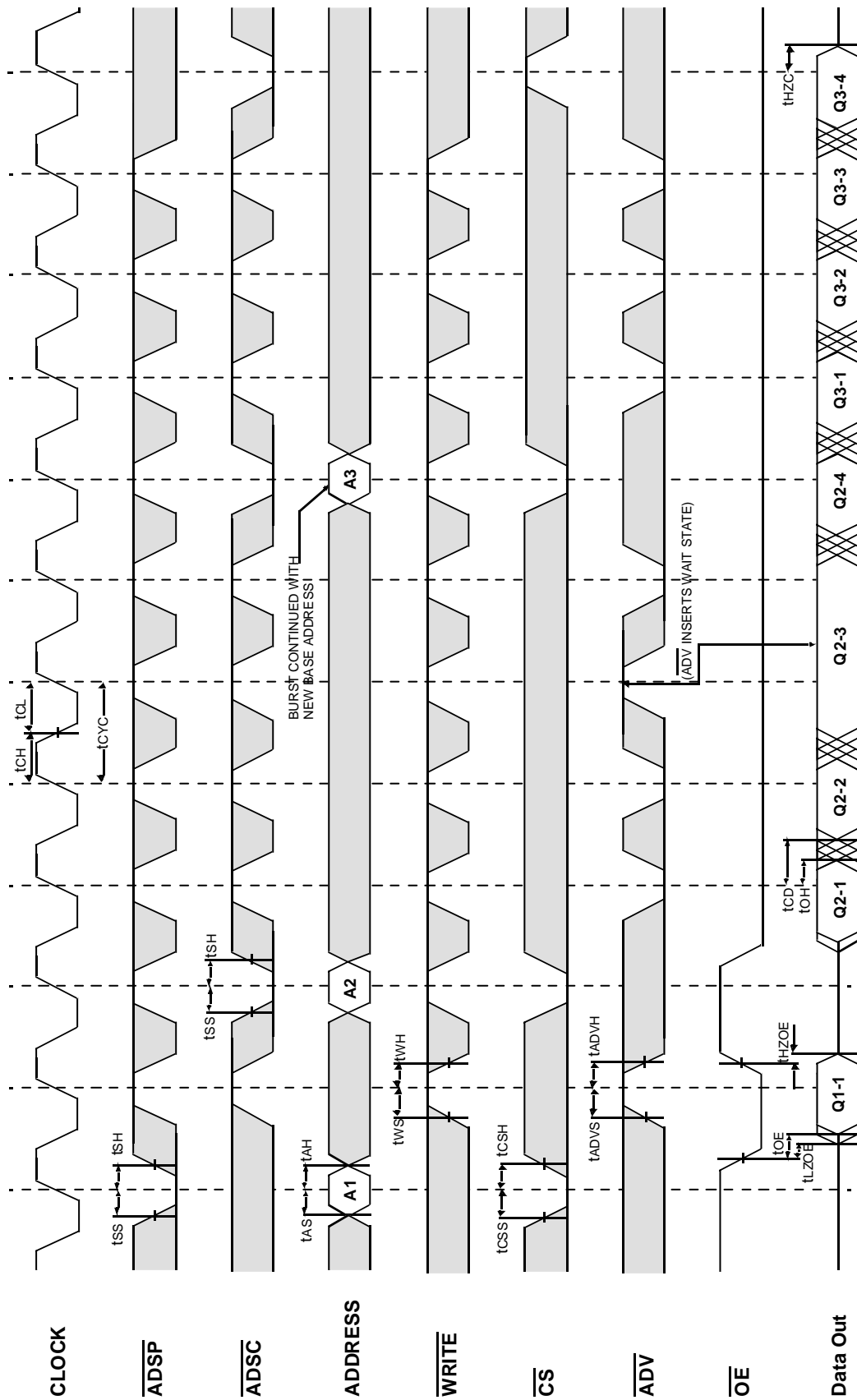

□ Don't Care  
⊠ Undefined

NOTES :  $\overline{WRITE} = L$  means  $\overline{GW} = L$ , or  $\overline{GW} = H$ ,  $\overline{BW} = L$ ,  $\overline{WE} = L$   
 $\overline{CS} = L$  means  $\overline{CS}_1 = L$ ,  $\overline{CS}_2 = H$  and  $\overline{CS}_2 = L$   
 $\overline{CS} = H$  means  $\overline{CS}_1 = H$ , or  $\overline{CS}_1 = L$  and  $\overline{CS}_2 = H$ , or  $\overline{CS}_1 = L$ , and  $\overline{CS}_2 = L$

TIMING WAVEFORM OF WRTE CYCLE

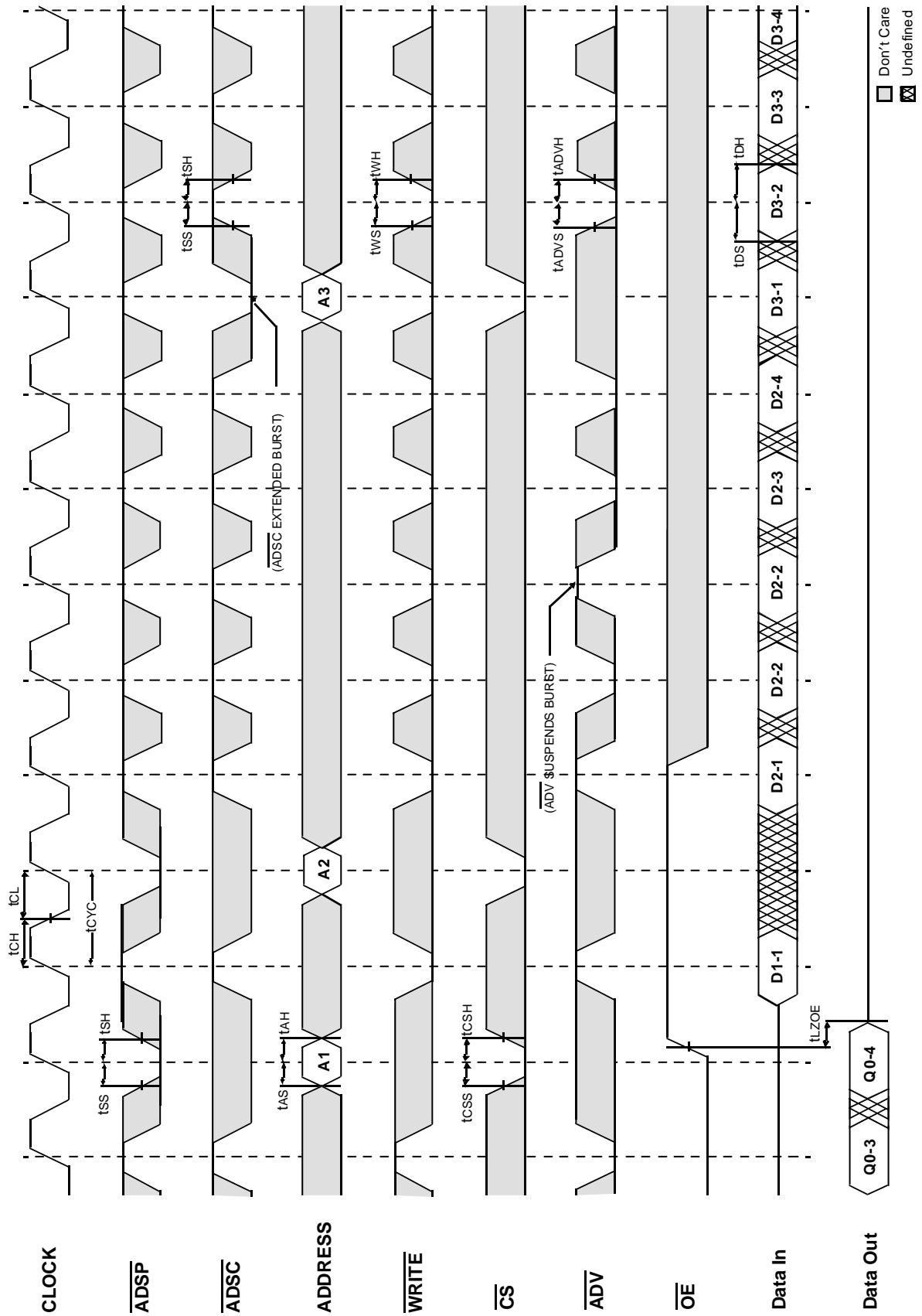

TIMING WAVEFORM OF COMBINATION READ/WRITE CYCLE(ADSP CONTROLLED, ADSC=HIGH)

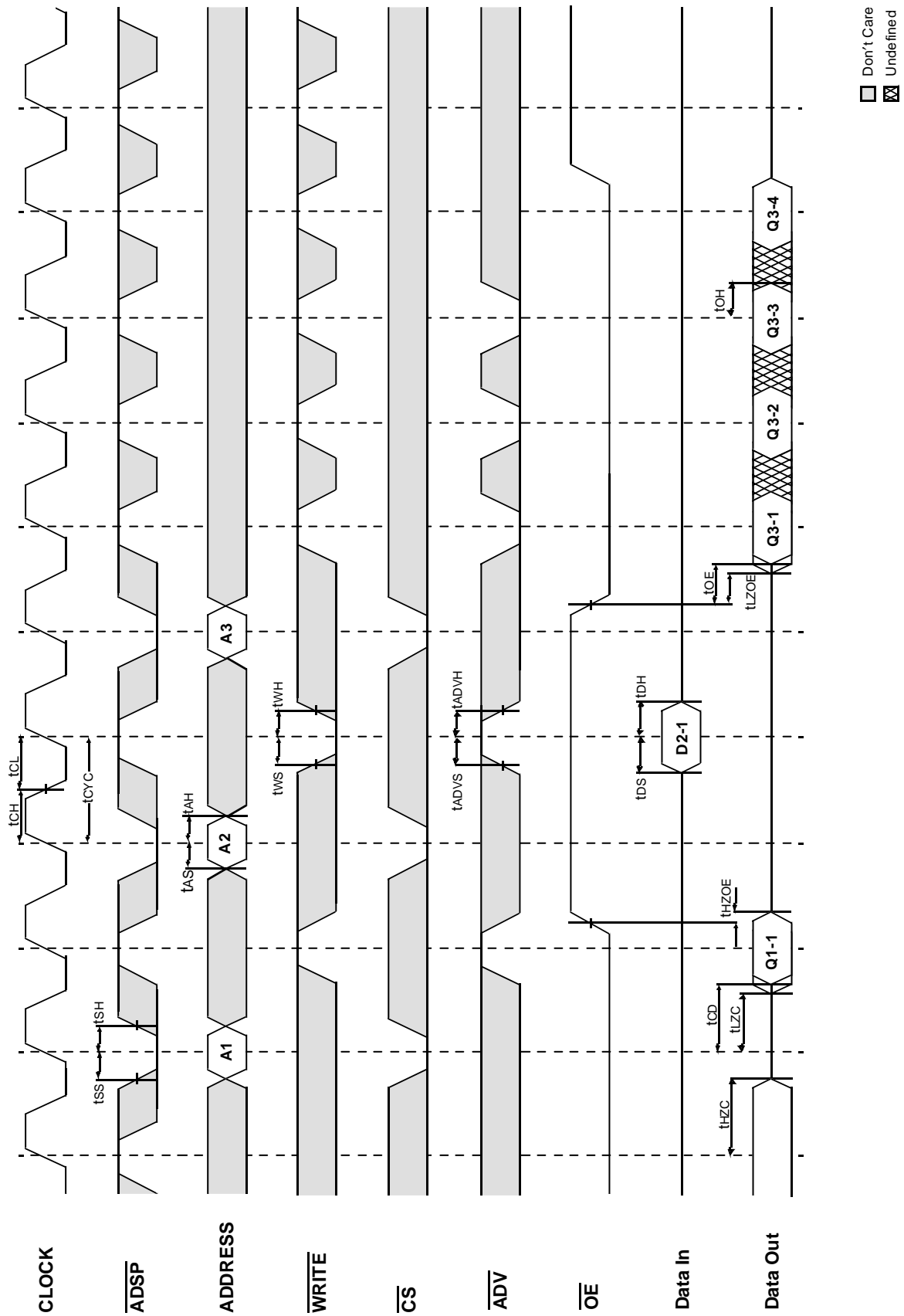

TIMING WAVEFORM OF SINGLE READ/WRITE CYCLE(ADSC CONTROLLED,  $\overline{\text{ADSP}}=\text{HIGH}$ )

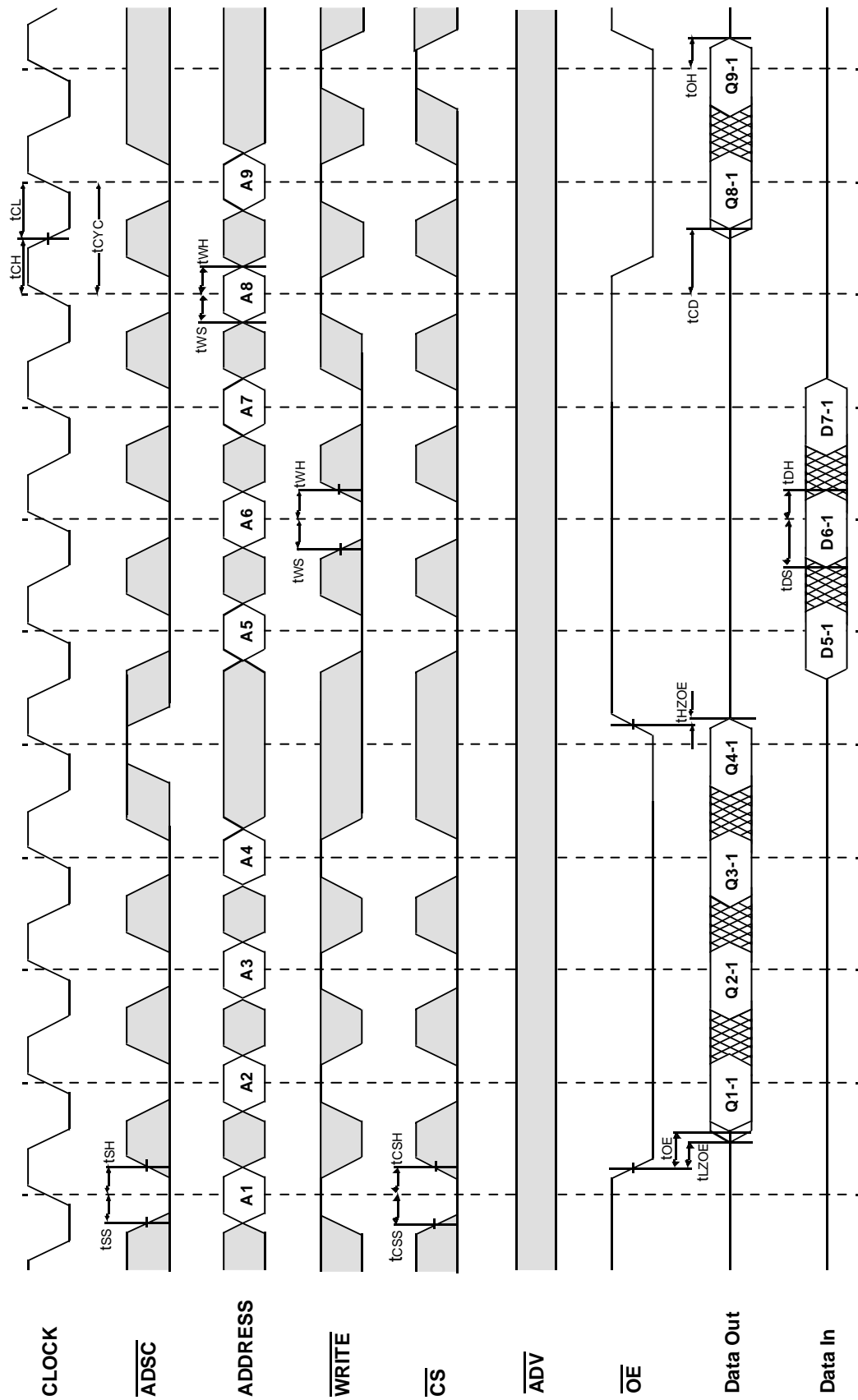

TIMING WAVEFORM OF SINGLE READ/WRITE CYCLE(ADSP CONTROLLED,  $\overline{\text{ADSC}}=\text{HIGH}$ )

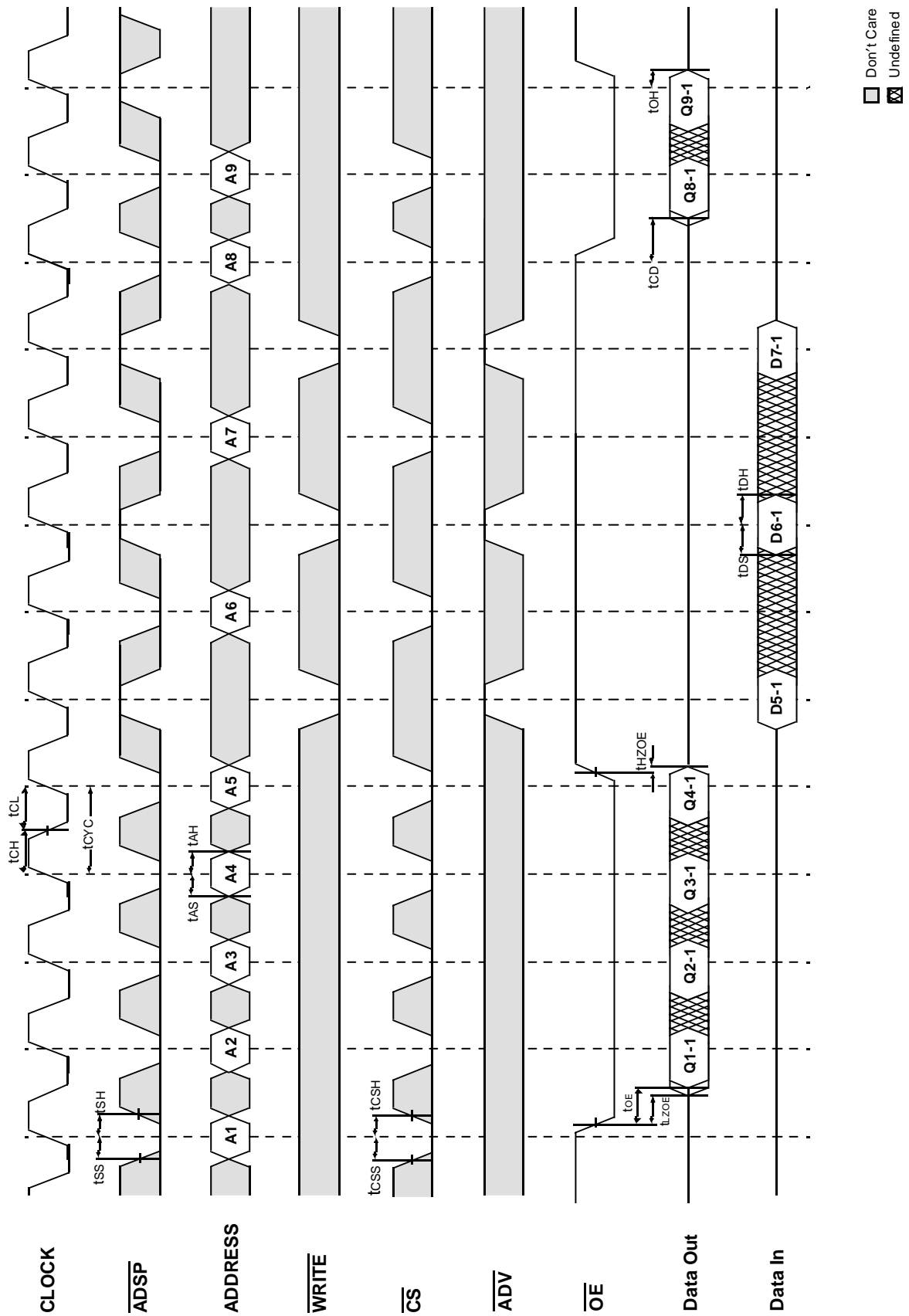





**APPLICATION INFORMATION**

**DEPTH EXPANSION**

The Samsung 512Kx36 Synchronous Burst SRAM has two additional chip selects for simple depth expansion. This permits easy secondary cache upgrades from 512K depth to 1M depth without extra logic.

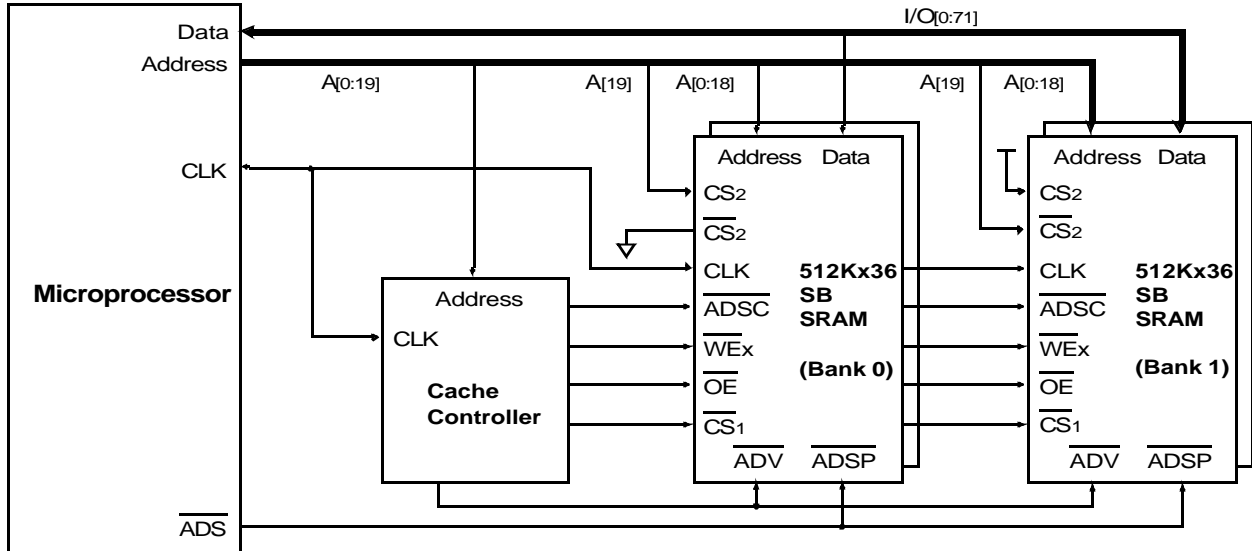

**INTERLEAVE READ TIMING** (Refer to non-interleave write timing for interleave write timing)

(ADSP CONTROLLED , ADSC=HIGH)

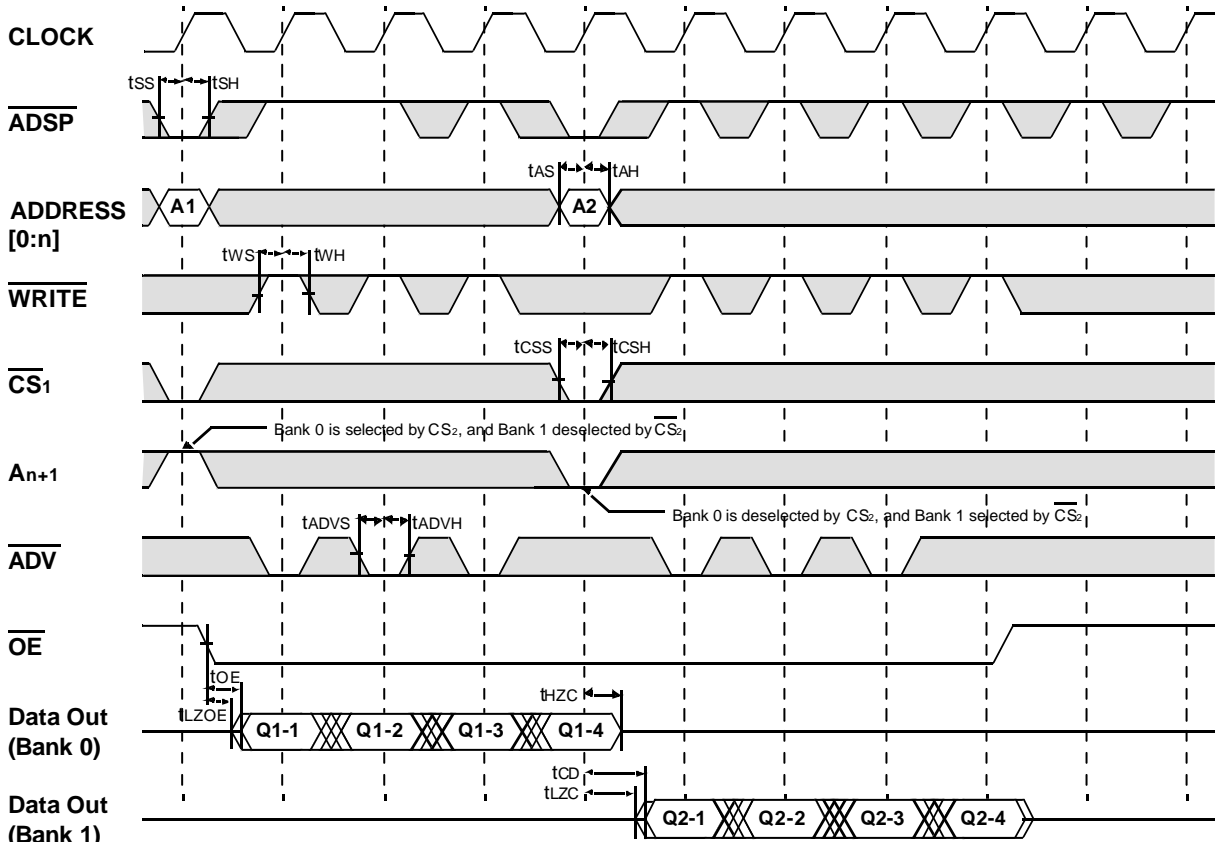

\*Notes : n = 14 32K depth , 15 64K depth  
16 128K depth , 17 256K depth  
18 512K depth , 19 1M depth

□ Don't Care    ⊗ Undefined

**APPLICATION INFORMATION**

**DEPTH EXPANSION**

The Samsung 1Mx18 Synchronous Burst SRAM has two additional chip selects for simple depth expansion. This permits easy secondary cache upgrades from 1M depth to 2M depth without extra logic.

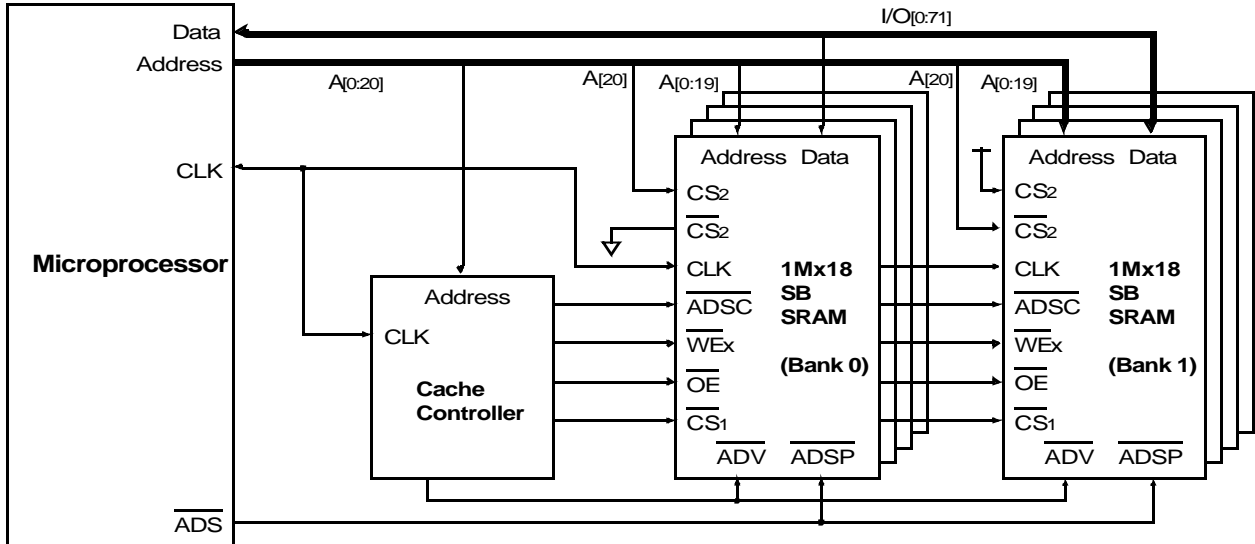

**INTERLEAVE READ TIMING** (Refer to non-interleave write timing for interleave write timing)

**(ADSP CONTROLLED, ADSC=HIGH)**

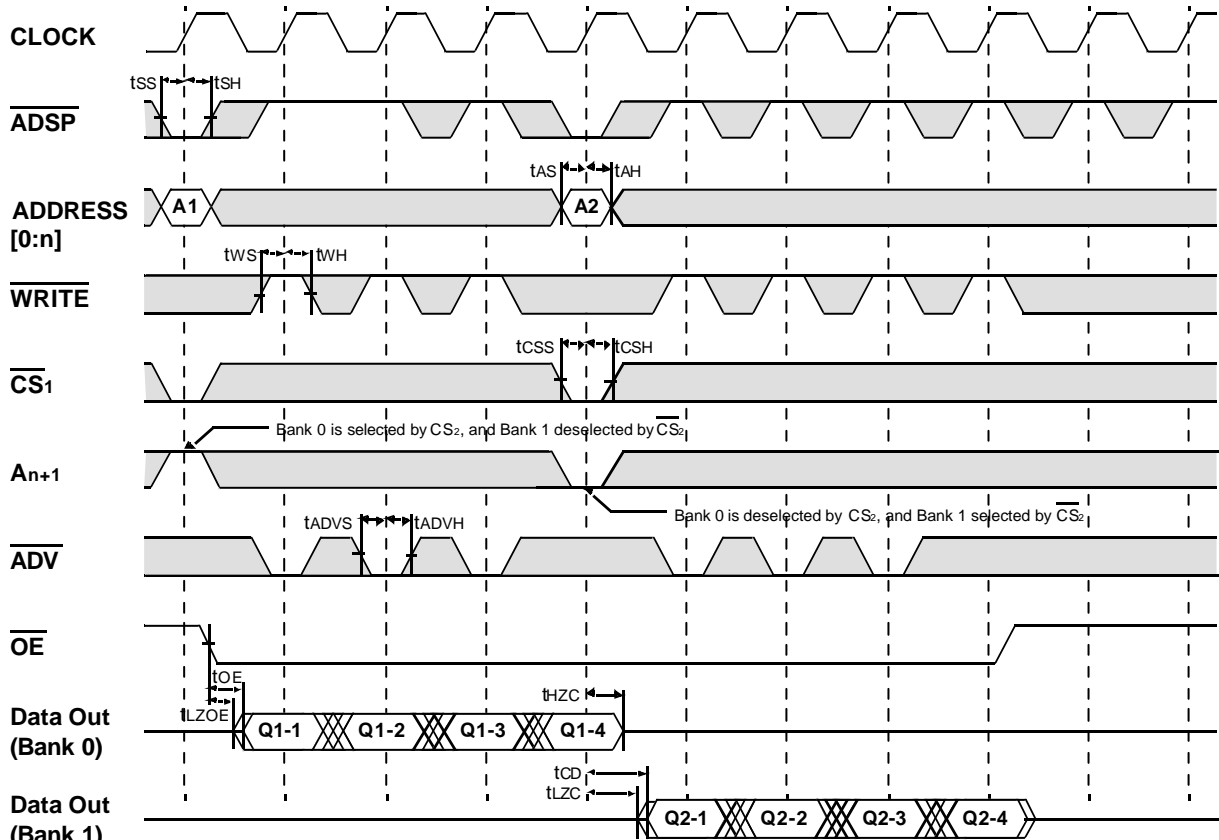

\*Notes : n = 14 32K depth, 15 64K depth  
 16 128K depth, 17 256K depth  
 18 512K depth, 19 1M depth  
 20 2M depth

□ Don't Care    ⊗ Undefined

PACKAGE DIMENSIONS

