



## FE050B, FE100B, FE150B Power Modules: dc-dc Converters; 38 Vdc to 60 Vdc Input, 12 Vdc Output; 50 W to 150 W



The FE050B, FE100B, and FE150B Power Modules use advanced, surface-mount technology and deliver high-quality, compact, dc-dc conversion at an economical price.

### Applications

- Redundant and distributed power architectures
- Telecommunications

### Options

- Output voltage set-point adjustment (trim)

### Description

The FE050B, FE100B, and FE150B Power Modules are dc-dc converters that operate over an input voltage range of 38 Vdc to 60 Vdc and provide a precisely regulated dc output. The outputs are fully isolated from the inputs, allowing versatile polarity configurations and grounding connections. The modules have maximum power ratings from 50 W to 150 W at a typical full-load efficiency of 86%.

Built-in filtering, for both the input and output of each device, eliminates the need for external filters. Two or more modules may be paralleled with forced load sharing for redundant or enhanced power applications. The package, which mounts on a printed-circuit board, accommodates a heat sink for high-temperature applications.

### Features

- High efficiency: 86% typical
- Parallel operation with load sharing
- Low profile: 12.7 mm (0.5 in.)
- Complete input and output filtering
- Within FCC requirements for Telecom
- Constant frequency
- Case ground pin
- Input-to-output isolation
- Remote sense
- Remote on/off
- Short-circuit protection
- Output overvoltage clamp
- *UL*\* Recognized, *CSA*† Certified, *TÜV*‡ Licensed

\* *UL* is a registered trademark of Underwriters Laboratories, Inc.  
† *CSA* is a registered trademark of Canadian Standards Association.  
‡ *TÜV* is a registered trademark of Technischer Überwachungs-Verein.

## Absolute Maximum Ratings

Stresses in excess of the absolute maximum ratings can cause permanent damage to the device. These are absolute stress ratings only. Functional operation of the device is not implied at these or any other conditions in excess of those given in the operations sections of the data sheet. Exposure to absolute maximum ratings for extended periods can adversely affect device reliability.

Parameter	Symbol	Min	Max	Unit
Input Voltage (continuous)	$V_I$	—	60	Vdc
I/O Isolation Voltage	—	—	500	V
Operating Case Temperature (See Thermal Considerations section and Figure 18.)	$T_C$	0	90	°C
Storage Temperature	$T_{stg}$	-55	125	°C

## Electrical Specifications

Unless otherwise indicated, specifications apply over all operating input voltage, resistive load, and temperature conditions.

**Table 1. Input Specifications**

Parameter	Symbol	Min	Typ	Max	Unit
Operating Input Voltage	$V_I$	38	48	60	Vdc
Maximum Input Current ( $V_I = 0$ V to 60 V):					
FE050B	$I_{I, max}$	—	—	2	A
FE100B	$I_{I, max}$	—	—	4	A
FE150B	$I_{I, max}$	—	—	6	A
Inrush Transient	$i^2t$	—	—	1.0	A <sup>2</sup> s
Input Reflected-ripple Current, Peak-to-peak (5 Hz to 20 MHz, 12 $\mu$ H source impedance) (See Figure 9.)	—	—	20	—	mAp-p
Input Ripple Rejection (120 Hz)	—	—	60	—	dB

## Fusing Considerations

**CAUTION: This power module is not internally fused. An input line fuse must always be used.**

This encapsulated power module can be used in a wide variety of applications, ranging from simple stand-alone operation to an integrated part of a sophisticated power architecture. To preserve maximum flexibility, internal fusing is not included; however, to achieve maximum safety and system protection, always use an input line fuse. The safety agencies require a normal-blow, dc fuse with a maximum rating of 6 A (see Safety Considerations section). Based on the information provided in this data sheet on inrush energy and maximum dc input current, the same type of fuse with a lower rating can be used. Refer to the fuse manufacturer's data for further information.

## Electrical Specifications (continued)

Table 2. Output Specifications

Parameter	Symbol	Min	Typ	Max	Unit
Output Voltage (Over all operating input voltage, resistive load, and temperature conditions until end of life; see Figure 10 and Feature Descriptions.)	V <sub>o</sub>	11.40	—	12.60	Vdc
Output Voltage Set Point (V <sub>i</sub> = 48 V; I <sub>o</sub> = I <sub>o, max</sub> ; T <sub>C</sub> = 25 °C): Unit Operating in Parallel or PARALLEL Pin Shorted to SENSE(–) (See Figure 10 and Feature Descriptions.)	V <sub>O, set</sub>	11.76	—	12.24	Vdc
PARALLEL Pin Open	V <sub>O, set</sub>	11.76	—	12.48	Vdc
Output Regulation: Line (V <sub>i</sub> = 36 V to 60 V)	—	—	0.05	0.2	%
Load (I <sub>o</sub> = I <sub>o, min</sub> to I <sub>o, max</sub> )	—	—	0.2	0.4	%
Temperature (T <sub>C</sub> = 0 °C to 90 °C)	—	—	—	120	mV
Output Ripple and Noise Voltage (See Figure 5 and Figure 11.):					
RMS	—	—	—	70	mVrms
Peak-to-peak (5 Hz to 20 MHz)	—	—	—	200	mVp-p
Output Current (At I <sub>o</sub> < I <sub>o, min</sub> , the modules may exceed output ripple specifications.):					
FE050B	I <sub>o</sub>	1	—	4.2	A
FE100B	I <sub>o</sub>	1	—	8.3	A
FE150B	I <sub>o</sub>	1	—	12.5	A
Output Current-limit Inception (V <sub>o</sub> = 90% of V <sub>O, set</sub> ; see Figure 2 and Feature Descriptions.)	—	103	—	130	% I <sub>o, max</sub>
Output Short-circuit Current (V <sub>o</sub> = 250 mV; see Figure 2.)	—	—	135	170	% I <sub>o, max</sub>
External Load Capacitance (electrolytic, total for one unit or multiple paralleled units):					
FE050B	—	0	—	400	μF
FE100B	—	0	—	400	μF
FE150B	—	0	—	400	μF
Efficiency (V <sub>i</sub> = 48 V; I <sub>o</sub> = I <sub>o, max</sub> ; T <sub>C</sub> = 25 °C; see Figure 3—Figure 9.):					
FE050B	η	84	85	—	%
FE100B	η	85	86	—	%
FE150B	η	85	86	—	%
Dynamic Response (ΔI <sub>o</sub> /Δt = 1 A/10 μs, V <sub>i</sub> = 48 V, T <sub>C</sub> = 25 °C; see Figure 6 and Figure 7.):					
Load Change from I <sub>o</sub> = 50% to 75% of I <sub>o, max</sub> :					
Peak Deviation	—	—	350	—	mV
Settling Time (V <sub>o</sub> < 10% of peak deviation)	—	—	300	—	μs
Load Change from I <sub>o</sub> = 50% to 25% of I <sub>o, max</sub> :					
Peak Deviation	—	—	350	—	mV
Settling Time (V <sub>o</sub> < 10% of peak deviation)	—	—	300	—	μs



### Characteristic Curves

The following figures provide typical characteristics for the FE150B Power Module. The FE050B and FE100B characteristics are similar to the FE150B characteristics provided here, scaled by power level where appropriate.

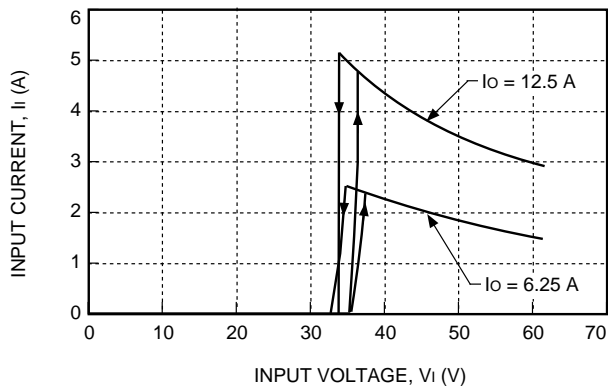

8-889 (C)

Figure 1. Typical FE150B Input Characteristics at Room Temperature

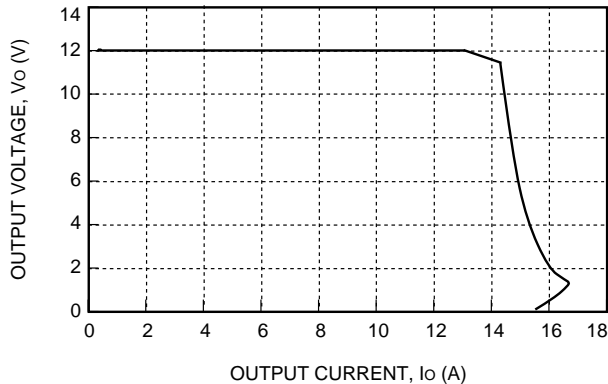

8-890 (C)

Figure 2. Typical FE150B Output Characteristics at Room Temperature and 48 V Input

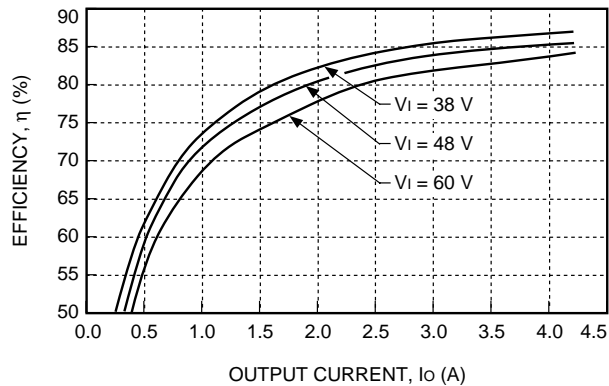

8-891 (C)

Figure 3. Typical FE050B Efficiency vs. Output Current at Room Temperature

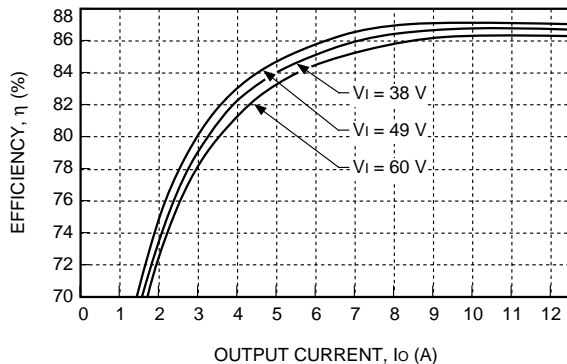

8-892 (C)

Figure 4. Typical FE150B Efficiency vs. Output Current at Room Temperature

Characteristic Curves (continued)

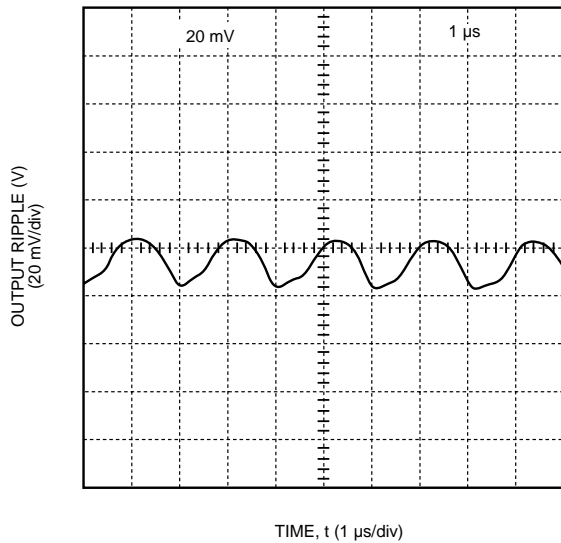

8-893 (C)

Figure 5. Typical FE150B Output Ripple Voltage at Room Temperature, 48 V Input, and 12.5 A Output

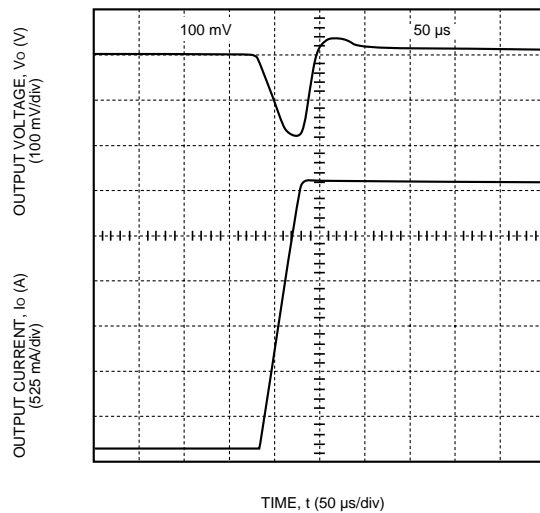

8-895 (C)

Figure 7. Typical FE150B Transient Response to Step Increase in Load from 50% to 75% of Full Load at Room Temperature and 48 V Input (Waveform Averaged to Eliminate Ripple Component.)

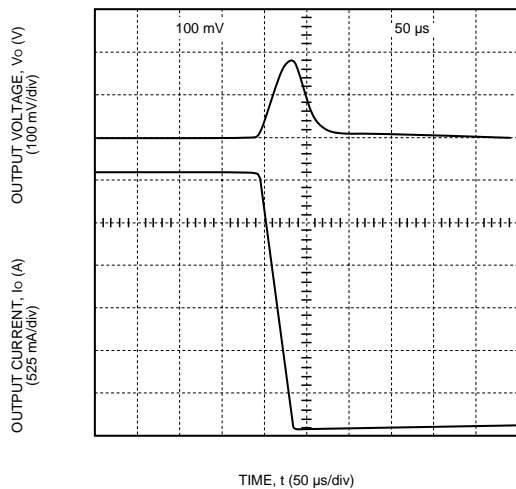

8-894 (C)

Figure 6. Typical FE150B Transient Response to Step Decrease in Load from 50% to 25% of Full Load at Room Temperature and 48 V Input (Waveform Averaged to Eliminate Ripple Component.)

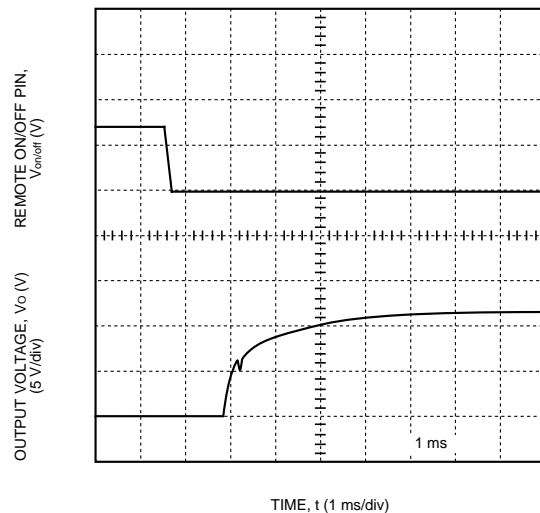

8-896 (C)

Figure 8. Typical FE150B Start-Up Transient at Room Temperature, 48 V Input, and 12.5 A Output

## Test Configurations

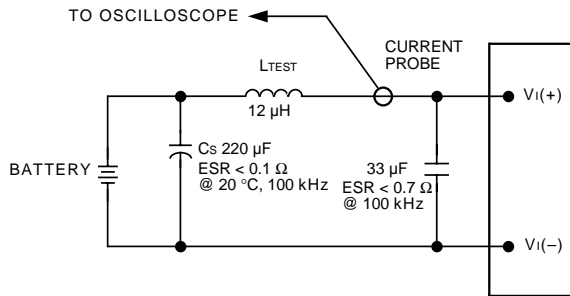

8-203 (C),I

Note: Measure input reflected-ripple current with a simulated source inductance ( $L_{TEST}$ ) of 12  $\mu\text{H}$ . Capacitor  $C_s$  offsets possible battery impedance. Measure current as shown above.

**Figure 9. Input Reflected-Ripple Test Setup**

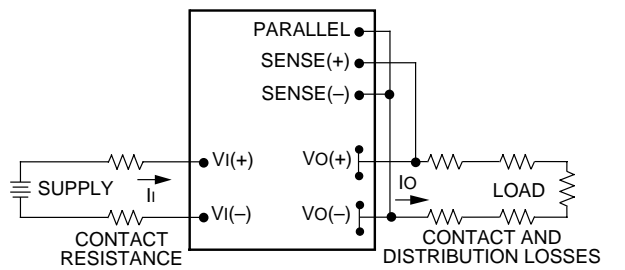

8-683 (C)

Note: All measurements are taken at the module terminals. When socketing, place Kelvin connections at module terminals to avoid measurement errors due to socket contact resistance.

$$\eta = \left( \frac{[V_{O(+)} - V_{O(-)}] I_o}{[V_{I(+)} - V_{I(-)}] I_i} \right) \times 100$$

**Figure 10. Output Voltage and Efficiency Measurement Test Setup**

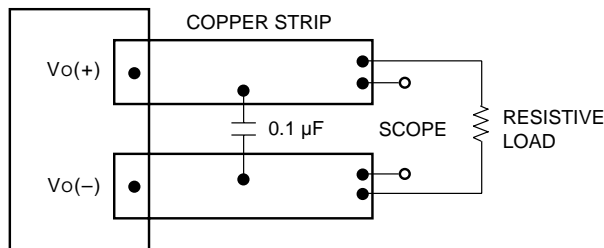

8-513 (C)

Note: Use a 0.1  $\mu\text{F}$  ceramic capacitor. Scope measurement should be made using a BNC socket. Position the load between 50 mm (2 in.) and 76 mm (3 in.) from the module.

**Figure 11. Peak-to-Peak Output Noise Measurement Test Setup**

## Design Considerations

### Input Source Impedance

The power module should be connected to a low ac-impedance input source. Highly inductive source impedances can affect the stability of the power module. For the test configuration in Figure 9, a 33  $\mu\text{F}$  electrolytic capacitor (ESR < 0.7  $\Omega$  at 100 kHz) mounted close to the power module helps ensure stability of the unit. For other highly inductive source impedances, consult the factory for further application guidelines.

### Safety Considerations

For safety-agency approval of the system in which the power module is used, the power module must be installed in compliance with the spacing and separation requirements of the end-use safety agency standard, i.e., *UL-1950*, *CSA 22.2-950*, and *EN60950*.

For the converter output to be considered meeting the requirements of safety extra-low voltage (SELV), the input must meet SELV requirements.

If the input meets extra-low voltage (ELV) requirements, then the converter's output is considered ELV.

The input to these units is to be provided with a maximum 6 A normal-blow fuse in the ungrounded lead.

## Electrical Descriptions

### Current Limit

To provide protection in a fault (output overload) condition, the unit is equipped with internal current-limiting circuitry and can endure current limiting for an unlimited duration. At the point of current-limit inception, the unit shifts from voltage control to current control. If the output voltage is pulled very low during a severe fault, the current-limit circuit can exhibit either foldback or tailout characteristics (output-current decrease or increase). The unit operates normally once the output current is brought back into its specified range.

## Feature Descriptions

### Remote On/Off

To turn the power module on and off, the user must supply a switch to control the voltage between the on/off terminal and the VI(-) terminal (Von/off). The switch can be an open collector or equivalent (see Figure 12). A logic low is Von/off = 0 V to 1.2 V, during which the module is on. The maximum Ion/off during a logic low is 1 mA. The switch should maintain a logic-low voltage while sinking 1 mA.

During a logic high, the maximum Von/off generated by the power module is 15 V. The maximum allowable leakage current of the switch at Von/off = 15 V is 50 µA.

If not using the remote on/off feature, short the ON/OFF pin to VI(-).

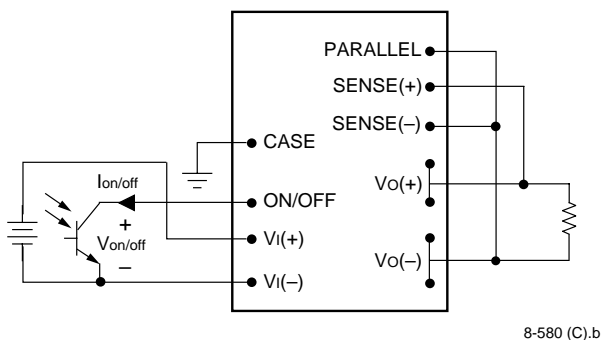

Figure 12. Remote On/Off Implementation

### Remote Sense

Remote sense minimizes the effects of distribution losses by regulating the voltage at the remote-sense connections. For single-unit operation, the PARALLEL pin should be connected to SENSE(-). The voltage between the remote-sense pins and the output terminals must not exceed the output voltage sense range

given in the Feature Specifications table, i.e.:

$$[V_o(+)-V_o(-)]-[SENSE(+)-SENSE(-)]\leq 1.2\text{ V}$$

The voltage between the Vo(+) and Vo(-) terminals must not exceed the minimum output overvoltage clamp voltage as indicated in the Feature Specifications table. This limit includes any increase in voltage due to remote-sense compensation and output voltage set-point adjustment (trim), see Figure 13.

If not using the remote-sense feature to regulate the output at the point of load, connect SENSE(+) to Vo(+) and SENSE(-) to Vo(-) at the module.

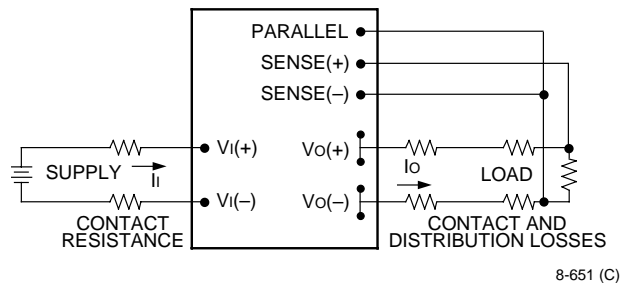

Figure 13. Effective Circuit Configuration for Single-Module Remote-Sense Operation

### Output Voltage Set-Point Adjustment (Trim)

When not using the trim feature, leave the TRIM pin open.

#### Adjustment with TRIM Pin

Output voltage adjustment allows the output voltage set point to be increased or decreased by adjusting an external resistor connected between the TRIM pin and either the SENSE(+) or SENSE(-) pins (see Figure 14 and Figure 15).

Connecting the external resistor (Rtrim-up) between the TRIM and SENSE(-) pins (Vo,adj) increases the output voltage set point as defined in the following equation:

$$R_{\text{trim-up}} = \left( \frac{1.25 \times 17.8}{V_{o,\text{adj}} - 12} \right) \text{ k}\Omega$$

Connecting the external resistor (Rtrim-down) between the TRIM and SENSE(+) pins (Vo,adj) decreases the output voltage set point as defined in the following equation:

$$R_{\text{trim-down}} = \left[ \frac{(V_{o,\text{adj}} - 1.25) \times 17.8}{12 - V_{o,\text{adj}}} \right] \text{ k}\Omega$$



## Feature Descriptions (continued)

### Output Voltage Set-Point Adjustment (Trim)

(continued)

#### Adjustment with TRIM Pin (continued)

The voltage between the Vo(+) and Vo(-) terminals must not exceed the minimum output overvoltage clamp voltage as indicated in the Feature Specifications table. This limit includes any increase in voltage due to remote-sense compensation and output voltage set-point adjustment (trim), see Figure 13.

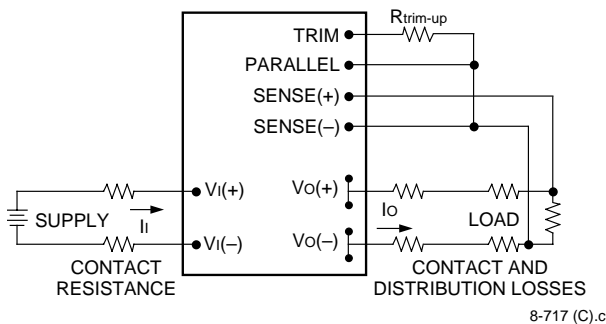

Figure 14. Circuit Configuration to Trim Up Output Voltage

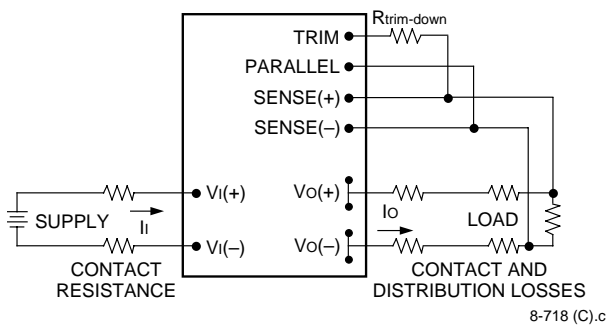

Figure 15. Circuit Configuration to Trim Down Output Voltage

#### Adjustment Without TRIM Pin

The output voltage can be adjusted by placing an external resistor ( $R_{adj}$ ) between the SENSE(+) and Vo(+) terminals (see Figure 16). By adjusting  $R_{adj}$ , the output voltage can be increased by 10% of the nominal output voltage. The equation below shows the resistance required to obtain the desired output voltage.

$$R_{adj} = (V_{O, adj} - V_{O, nom}) 899 \Omega$$

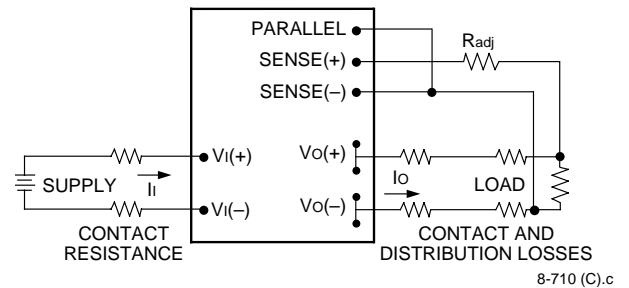

Figure 16. Circuit Configuration to Adjust Output Voltage

#### Forced Load Sharing (Parallel Operation)

For either redundant operation or additional power requirements, the power modules can be configured for parallel operation with forced load sharing (see Figure 17). For a typical redundant configuration, Schottky diodes or an equivalent should be used to protect against short-circuit conditions. Because of the remote sense, the forward-voltage drops across the Schottky diodes do not affect the set point of the voltage applied to the load. For additional power requirements, where multiple units are used to develop combined power in excess of the rated maximum, the Schottky diodes are not needed.

Good layout techniques should be observed for noise immunity. To implement forced load sharing, the following connections must be made:

- The parallel pins of all units must be connected together. The paths of these connections should be as direct as possible.
- All remote-sense pins should be connected to the power bus at the same point, i.e., connect all SENSE(+) pins to the (+) side of the power bus at the same point and all SENSE(-) pins to the (-) side of the power bus at the same point. Close proximity and directness are necessary for good noise immunity.

**Feature Descriptions** (continued)

**Forced Load Sharing (Parallel Operation)**  
(continued)

When not using the parallel feature, short the PARALLEL pin to SENSE(-).

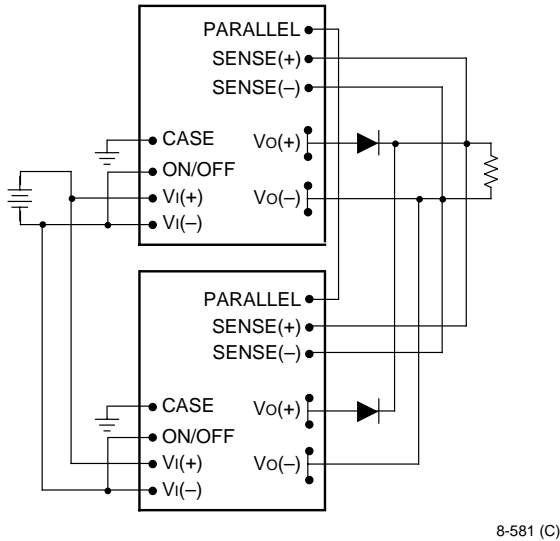

**Figure 17. Wiring Configuration for Redundant Parallel Operation**

**Output Overvoltage Clamp**

The output overvoltage clamp consists of control circuitry, independent of the primary regulation loop, that monitors the voltage on the output terminals. The control loop of the clamp has a higher voltage set point than the primary loop (see Feature Specifications table). This provides a redundant voltage-control that reduces the risk of output overvoltage.

**Thermal Considerations**

**Introduction**

The power modules operate in a variety of thermal environments; however, sufficient cooling should be provided to help ensure reliable operation of the unit. Heat-dissipating components inside the unit are thermally coupled to the case. Heat is removed by conduction, convection, and radiation to the surrounding environment. Proper cooling can be verified by measuring the case temperature. Peak temperature occurs at the position indicated in Figure 18.

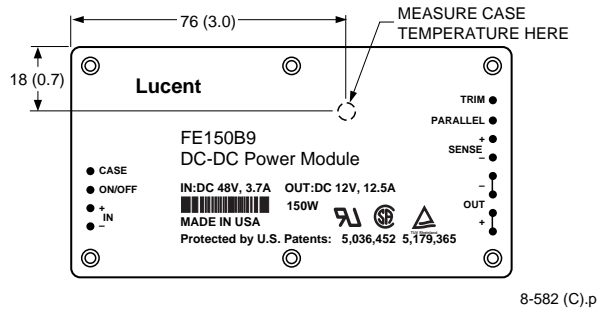

Note: Top view, measurements shown in millimeters and (inches).

**Figure 18. Case Temperature Measurement Location**

The temperature at this location should not exceed 95 °C. The maximum case temperature can be limited to a lower value for extremely high reliability. The output power of the module should not exceed the rated power for the module as listed in the Ordering Information table.

For additional information about these modules, refer to the Lucent Technologies *Thermal Management for High-Power Board-Mounted Power Modules* Technical Note (TN97-009EPS).

**Heat Transfer Without Heat Sinks**

Derating curves for forced-air cooling without a heat sink are shown in Figure 19. These curves can be used to determine the appropriate airflow for a given set of operating conditions. For example, if the unit dissipates 20 W of heat, the correct airflow in a 40 °C environment is 1.0 m/s (200 ft./min.).

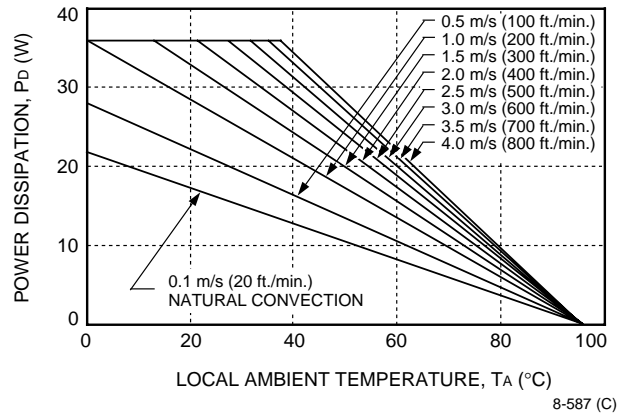

**Figure 19. Power Derating vs. Local Ambient Temperature and Air Velocity**

## Thermal Considerations (continued)

### Heat Transfer with Heat Sinks

The power modules have threaded #4-40 fasteners, which enable heat sinks or cold plates to be attached to the module. The mounting torque must not exceed 0.56 N-m (5 in.-lb.).

Thermal derating with heat sinks is expressed by using the overall thermal resistance of the module. Total module thermal resistance ( $\theta_{ca}$ ) is defined as the maximum case temperature rise ( $\Delta T_{C, max}$ ) divided by the module power dissipation ( $P_D$ ):

$$\theta_{ca} = \left[ \frac{\Delta T_{C, max}}{P_D} \right] = \left[ \frac{(T_C - T_A)}{P_D} \right]$$

The location to measure case temperature ( $T_C$ ) is shown in Figure 18. Case-to-ambient thermal resistance vs. airflow for various heat sink configurations is shown in Figure 20 and Figure 21. These curves were obtained by experimental testing of heat sinks, which are offered in the product catalog.

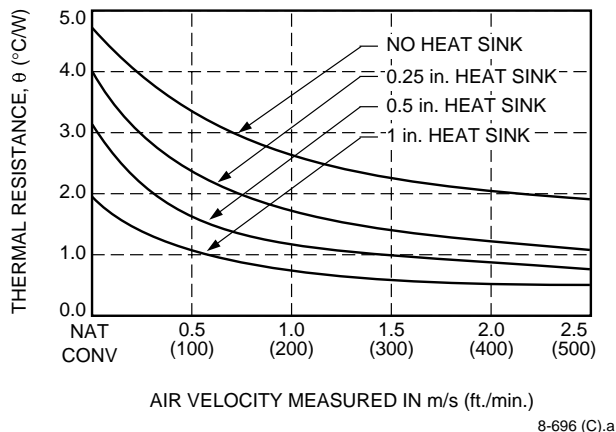

Figure 20. Heat Sink Resistance Curves; Fins Oriented Along Width

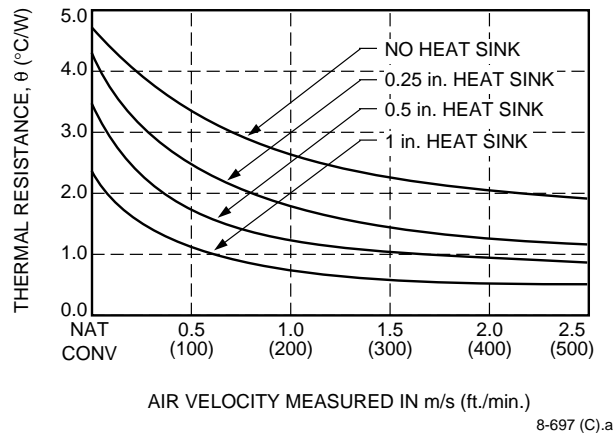

Figure 21. Heat Sink Resistance Curves; Fins Oriented Along Length

These measured resistances are from heat transfer from the sides and bottom of the module as well as the top side with the attached heat sink; therefore, the case-to-ambient thermal resistances shown are generally lower than the resistance of the heat sink by itself. The module used to collect the data in Figure 20 and Figure 21 had a thermal-conductive dry pad between the case and the heat sink to minimize contact resistance.

To choose a heat sink, determine the power dissipated as heat by the unit for the particular application. Figure 22 shows typical heat dissipation for a range of output currents and three voltages for the FE050B, FE100B, and FE150B.

## Thermal Considerations (continued)

### Heat Transfer with Heat Sinks (continued)

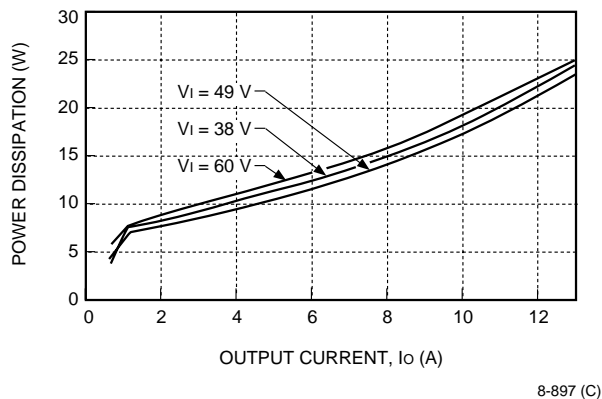

Figure 22. FE150B Power Dissipation as Heat vs. Output Current

#### Example

If an 85 °C case temperature is desired, what is the minimum airflow necessary? Assume the FE150B module is operating at low line and an output current of 12.5 A, maximum ambient air temperature of 40 °C, and the heat sink is 0.5 inch.

#### Solution

Given:  $V_i = 38$  V  
 $I_o = 12.5$  A  
 $T_A = 40$  °C  
 $T_C = 85$  °C  
 Heat sink = 0.5 inch.

Determine  $P_D$  by using Figure 22:

$$P_D = 24 \text{ W}$$

Then solve the following equation:

$$\theta_{ca} = \left[ \frac{(T_C - T_A)}{P_D} \right]$$

$$\theta_{ca} = \left[ \frac{(85 - 40)}{24} \right]$$

$$\theta_{ca} = 1.88 \text{ °C/W}$$

Use Figure 20 and Figure 21 to determine air velocity for the 0.5 inch heat sink. The minimum airflow necessary for the FE150B module depends on heat sink fin orientation and is shown below:

- 0.4 m/s (80 ft./min.) (oriented along width)
- 0.45 m/s (90 ft./min.) (oriented along length)

### Custom Heat Sinks

A more detailed model can be used to determine the required thermal resistance of a heat sink to provide necessary cooling. The total module resistance can be separated into a resistance from case-to-sink ( $\theta_{cs}$ ) and sink-to-ambient ( $\theta_{sa}$ ) shown below (Figure 23).

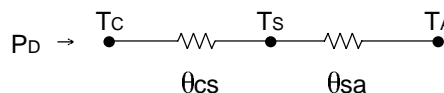

Figure 23. Resistance from Case-to-Sink and Sink-to-Ambient

For a managed interface using thermal grease or foils, a value of  $\theta_{cs} = 0.1$  °C/W to 0.3 °C/W is typical. The solution for heat sink resistance is:

$$\theta_{sa} = \left[ \frac{(T_C - T_A)}{P_D} \right] - \theta_{cs}$$

This equation assumes that all dissipated power must be shed by the heat sink. Depending on the user-defined application environment, a more accurate model, including heat transfer from the sides and bottom of the module, can be used. This equation provides a conservative estimate for such instances.

### Layout Considerations

Copper paths must not be routed beneath the power module standoffs.

## Outline Diagram

Dimensions are in millimeters and (inches).

Tolerances: x.x mm  $\pm$  0.5 mm (x.xx in.  $\pm$  0.02 in.),  
x.xx mm  $\pm$  0.25 mm (x.xxx in.  $\pm$  0.010 in.)

### Top View

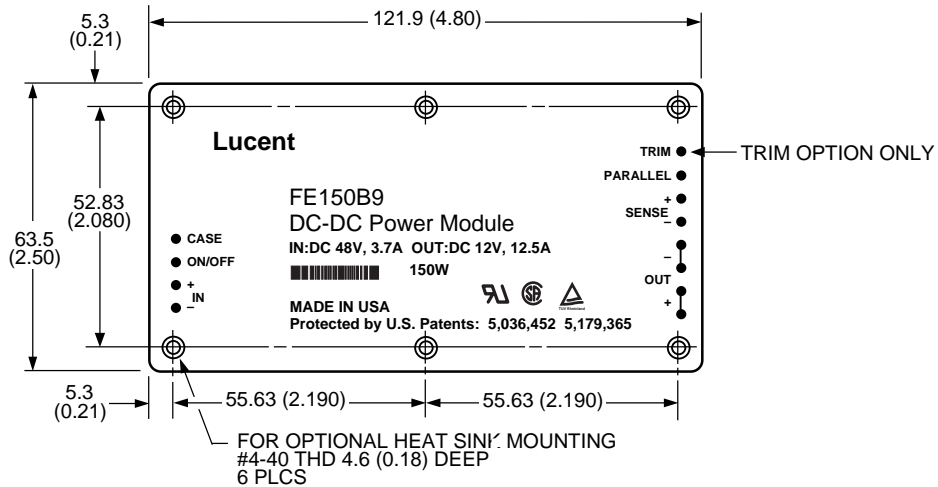

### Side View

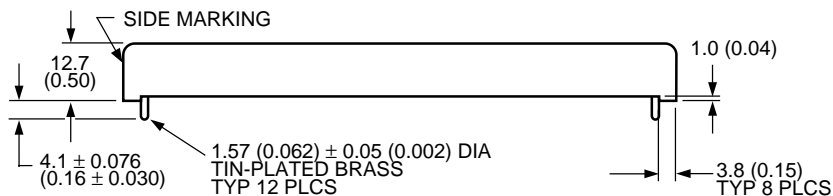

### Bottom View

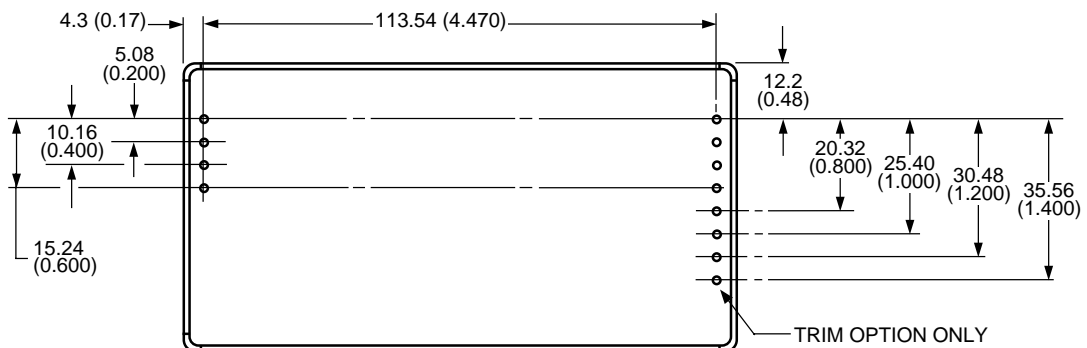

## Recommended Hole Pattern

Component-side footprint.

Dimensions are in millimeters and (inches).

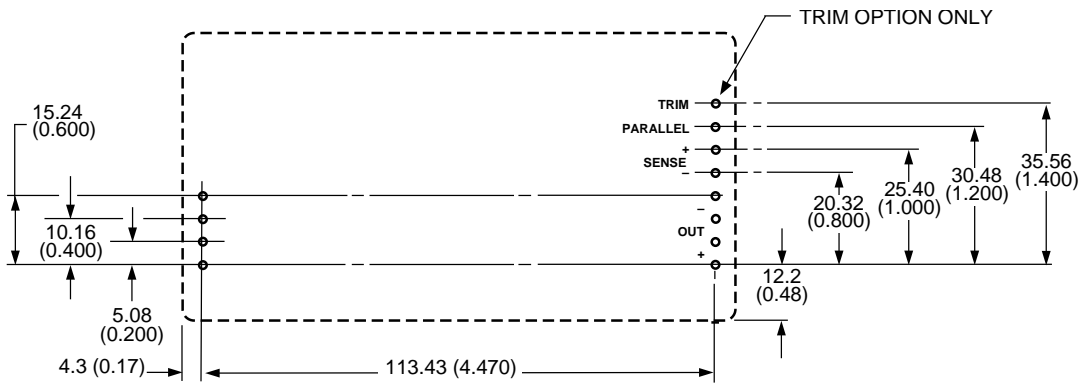

8-719 (C).m

## Ordering Information

**This family of modules is not recommended for new designs.** For new designs, we recommend the JFW family of power modules. Please refer to the Lucent Technologies Power Systems Selection Guide or to individual data sheets. For further assistance, you may call the Lucent Technologies Power Systems Technical Hotline (1-800-526-7819 or 972-284-2626).

Optional TRIM pin is designated by the ending 9 in device code name.

Input Voltage	Output Voltage	Output Power	Trim	Device Code	Comcode
48 V	12 V	50 W	Yes	FE050B9	Not Available
48 V	12 V	100 W	Yes	FE100B9	Not Available
48 V	12 V	150 W	Yes	FE150B9	Not Available
48 V	12 V	50 W	No	FE050B	106258304
48 V	12 V	100 W	No	FE100B	106258353
48 V	12 V	150 W	No	FE150B	105775530

## Notes

---

For additional information, contact your Lucent Technologies Account Manager or the following:

POWER SYSTEMS UNIT: Network Products Group, Lucent Technologies Inc., 3000 Skyline Drive, Mesquite, TX 75149, USA

**+1-800-526-7819** (Outside U.S.A.: **+1-972-284-2626**, FAX +1-972-329-8202) (product-related questions or technical assistance)

INTERNET: <http://www.lucent.com>

E-MAIL: [techsupport@lucent.com](mailto:techsupport@lucent.com)

ASIA PACIFIC: Lucent Technologies Singapore Pte. Ltd., 750A Chai Chee Road #05-01, Chai Chee Industrial Park, Singapore 469001

**Tel. (65) 240 8041**, FAX (65) 240 8053

JAPAN: Lucent Technologies Japan Ltd., 7-18, Higashi-Gotanda 2-chome, Shinagawa-ku, Tokyo 141-0022, Japan

**Tel. (81) 3 5421 1600**, FAX (81) 3 5421 1700

LATIN AMERICA: Lucent Technologies Inc., Room 9N128, One Alhambra Plaza, Coral Gables, FL 33134, USA

**Tel. +1-305-569-4722**, FAX +1-305-569-3820

EUROPE: Data Requests: DATALINE: **Tel. (44) 1189 324 299**, FAX (44) 1189 328 148

Technical Inquiries: GERMANY: **(49) 89 95086 0** (Munich), UNITED KINGDOM: **(44) 1344 865 900** (Bracknell),

FRANCE: **(33) 1 48 83 68 00** (Paris), SWEDEN: **(46) 8 600 7070** (Stockholm), FINLAND: **(358) 9 4354 2800** (Helsinki),

ITALY: **(39) 2 6608131** (Milan), SPAIN: **(34) 1 807 1441** (Madrid)

---

Lucent Technologies Inc. reserves the right to make changes to the product(s) or information contained herein without notice. No liability is assumed as a result of their use or application. No rights under any patent accompany the sale of any such product(s) or information.

