

Stereo 2.8W Audio Power Amplifier with DC Volume Control and Selectable Gain

Features

- Operating Voltage : 3.3V to 5V
- Stereo switchable bridged/single-ended power amplifiers
- DC Volume Control Interface , 0dB to -105dB
- Low Supply Current , $I_{DD} = 13\text{mA}$ at Stereo BTL
- Low Shutdown Current , $I_{DD} = 0.7\mu\text{A}$
- Bridge-Tied Load (BTL) or Single-Ended-(SE) Modes Operation
- Output Power at 1% THD+N , $V_{DD}=5\text{V}$
 - 2.2W/Ch (typ) into a 3 Ω Load
 - 2.0W/Ch (typ) into a 4 Ω Load
 - 1.2W/Ch (typ) into a 8 Ω Load
- Output Power at 10% THD+N , $V_{DD}=5\text{V}$
 - 2.8W/Ch (typ) into a 3 Ω Load
 - 2.3W/Ch (typ) into a 4 Ω Load
 - 1.5W/Ch (typ) into a 8 Ω Load
- Single-ended mode at 1.0% THD+N
 - 95mW/Ch (typ) into 32 Ω Load
- Depop Circuitry Integrated
- System Beep Detect
- Thermal shutdown protection circuitry
- High supply voltage ripple rejection
- Low Crossover Distortion
- PC99 Compliant
- 28-pin TSSOP-P (with enhanced thermal pad) power package available

Applications

- Notebook and Desktop Computers
- Multimedia Monitors
- Portable Applications

General Description

The APA4835 is a monolithic integrated circuit , which provides DC volume control , and a stereo bridged audio power amplifiers capable of producing 2.8W (2.2W) into 3 Ω with less than 10% (1.0%) THD+N. APA4835 includes a DC volume control , stereo bridge-tied and single-ended audio power amplifiers , stereo docking outputs , and a selectable gain control , that makes it optimally fittable for notebook PC , multimedia monitors , and other portable applications. The attenuator range of the volume control in APA4835 is from 0dB (DC_Vol=0.7V_{DD}) to -105dB (DC_Vol=0V) with 32 steps. Both of the depop circuitry and the thermal shutdown protection circuitry are integrated in APA4835 , that reduces pops and clicks noise during power up or shutdown mode operation , and protects the chip from being destroyed by over temperature failure. To simplify the audio system design , APA4835 combines a stereo bridge-tied loads (BTL) mode for speaker drive and a stereo single-end (SE) mode for headphone drive into a single chip , where both modes are easily switched by the SE/BTL input control pin signal. Besides the low supply current design to increase the efficiency of the amplifiers , APA4835 also features a shutdown function which keeps the supply current only 0.7 μA (typ).

Pin Description

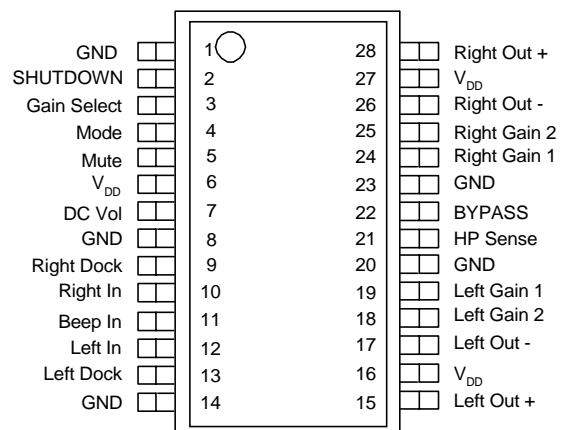

ANPEC reserves the right to make changes to improve reliability or manufacturability without notice, and advise customers to obtain the latest version of relevant information to verify before placing orders.

Ordering Information

<p>APA4835 □□-□□</p> <p style="margin-left: 40px;">└─ Handling Code</p> <p style="margin-left: 40px;">└─ Temp. Range</p> <p style="margin-left: 40px;">└─ Package Code</p>	<p>Package Code R : TSSOP-P Temp. Range I : -40 to 85 °C Handling Code TU : Tube TR : Tape & Reel</p>
<p>APA4835 R :  APA4835 XXXXX </p>	<p>XXXXX - Date Code</p>

Block Diagram

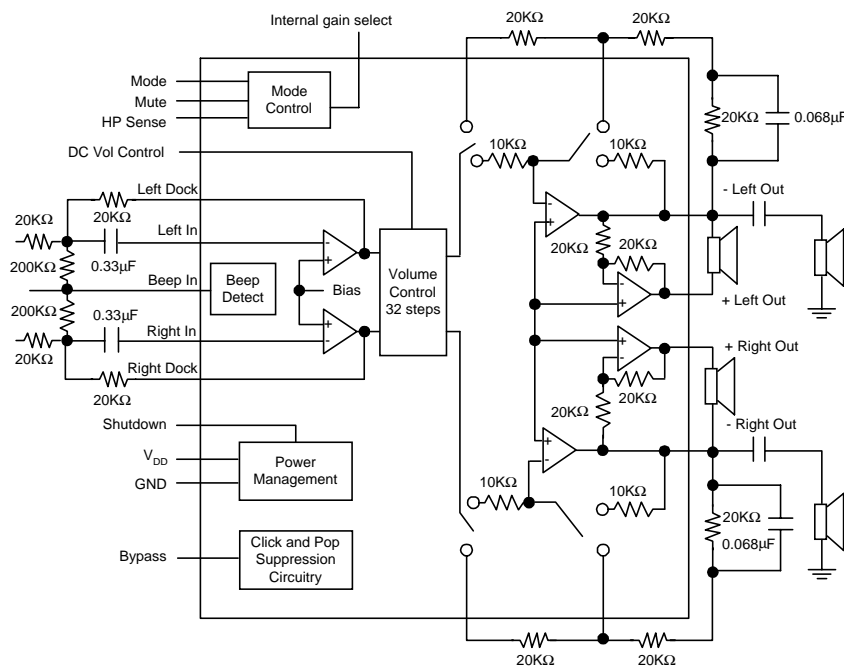

Absolute Maximum Ratings

(Over operating free-air temperature range unless otherwise noted.)

Symbol	Parameter	Rating	Unit
V_{DD}	Supply Voltage	6	V
T_A	Operating Ambient Temperature Range	-40 to 85	°C
T_J	Maximum Junction Temperature	Internally limited*1	°C
T_{STG}	Storage Temperature Range	-65 to +150	°C
T_S	Soldering Temperature, 10 seconds	260	°C
V_{ESD}	Electrostatic Discharge	-2000 to 2000*2	V

Note : *1. APA4835 integrates internal thermal shutdown protection when junction temperature ramp up to 150°C.

*2. Human body model : C=100pF, R=1500Ω, 3 positive pulses plus 3 negative pulses

Thermal Characteristics

Symbol	Parameter	Rating	Unit
R _{THJA}	Thermal Resistance from Junction to Ambient in Free Air		
	TSSOP-P*	60	°C/W
	TSSOP-P**	35	

*5in² printed circuit board with 2oz trace and copper pad through 12 25mil diameter vias. The thermal pad on the TSSOP_P package without solder on the printed circuit board.

**5in² printed circuit board with 2oz trace and copper pad through 12 25mil diameter vias. The thermal pad on the TSSOP_P package with solder on the printed circuit board.

Electrical Characteristics

Electrical Characteristics for Entire IC

The following specifications apply for V_{DD}= 5V unless otherwise noted. Limits apply for T_A= 25°C

Symbol	Parameter	Test Conditions	APA4835			Unit
			Min.	Typ.	Max.	
V _{DD}	Supply Voltage		3.3		5.5	V
I _{DD}	Quiescent Power Supply Current	V _{IN} =0V, I _O =0A		13	25	mA
I _{SD}	Shutdown Current	V _{PIN2} = V _{DD}		0.7	2.0	μA
V _{IH}	SE/BTL High Input Voltage		4			V
V _{IL}	SE/BTL Low Input Voltage				0.8	V

Electrical Characteristics for Volume Attenuators

The following specifications apply for V_{DD}= 5V. Limits apply for T_A= 25°C

Symbol	Parameter	Test Conditions	APA4835			Unit
			Min.	Typ.	Max.	
C _{RANGE}	Attenuator Range	Gain with V _{PIN7} =5V			±0.5	dB
		Attenuation with V _{PIN7} =0V	-90	-105		
A _M	Mute Attenuation	V _{PIN5} =5V, Bridged Mode	-88			dB
		V _{PIN5} =5V, Single-Ended Mode	-88			

Electrical Characteristics for BTL Mode Operation

The following specifications apply for V_{DD}= 5V unless otherwise noted. Limits apply for T_A= 25°C

Symbol	Parameter	Test Conditions	APA4835	Unit
			Typ.	
V _{OS}	Output Offset Voltage	V _{IN} =0V	5	mV
P _O	Output Power	THD=1%, f=1kHz R _L =3Ω R _L =4Ω R _L =8Ω THD=10%, f=1kHz R _L =8Ω	2.2 2.0 1.2 1.5	W

Electrical Characteristics (Cont.)

Electrical Characteristics for BTL Mode Operation (Cont.)

The following specifications apply for $V_{DD}=5V$ unless otherwise noted. Limits apply for $T_A=25^\circ C$

Symbol	Parameter	Test Conditions	APA4835	Unit
			Typ.	
THD+N	Total Harmonic Distortion + Noise	$A_{VD}=2, 20Hz < f < 20kHz$	0.2 0.15 0.1	%
		$R_L=4\Omega, P_O=1W$		
		$R_L=8\Omega, P_O=1W$		
		$R_L=32\Omega, P_O=340mW$		
PSRR	Power Supply Rejection Ratio	$V_{RIPPLE}=200mV_{RMS}, R_L=8\Omega$ $C_B=2.2\mu F, f=120Hz$	74	dB
X_{TALK}	Channel Separation	$f=1kHz, C_B=2.2\mu F$	95	dB
SNR	Signal-to-Noise Ratio	$V_{DD}=5V, P_O=1.1W, R_L=8\Omega, A\text{-Wtd}$ Filter	95	dB
V_N	Output Noise Voltage	$R_L=8\Omega, A\text{-Wtd}$ Filter	30	μV

Electrical Characteristics for SE Mode Operation

The following specifications apply for $V_{DD}=5V$ unless otherwise noted. Limits apply for $T_A=25^\circ C$

Symbol	Parameter	Test Conditions	APA4835	Unit
			Typ.	
V_{OS}	Output Offset Voltage	$V_{IN}=0V$	5	mV
P_O	Output Power	THD=1%, $f=1kHz, R_L=32\Omega$	95	mW
		THD=10%, $f=1kHz, R_L=32\Omega$	100	
THD+N	Total Harmonic Distortion plus Noise	$A_V=1, V_{OUT}=1V_{RMS}, f=1kHz, R_L=1k\Omega$	0.01	%
		$P_O=75mW, R_L=32\Omega, A_V=1, f=1kHz$	0.005	%
PSRR	Power Supply Rejection Ratio	$V_{RIPPLE}=200mV_{RMS}, f=120Hz, C_B=2.2\mu F$	58	dB
X_{TALK}	Channel Separation	$f=1kHz, C_B=2.2\mu F$	95	dB
SNR	Signal-to-Noise Ratio	$P_O=75mW, R_L=32\Omega, A\text{-Wtd}$ Filter	102	dB
V_N	Output Noise Voltage	$R_L=1k\Omega, A\text{-Wtd}$ Filter	40	μV

Pin Description

Pin		I/O	Description
Name	No		
GND	1, 8, 14, 20, 23		Ground connection for circuitry.
Shutdown	2	I	Shutdown mode control signal input, place entire IC in shutdown mode when held high, $I_{DD}=0.7\mu A$
Gain Select	3	I	Gain select input pin
Mode	4	I	Mode select input pin
Mute	5	I	Mute control input pin

Pin Description

Pin		I/O	Description
Name	No		
VDD	6, 16, 27		Supply voltage input pin
DC_Vol	7	I	Volume control function input pin.
Right Dock	9	O	Right docking output pin
Right In	10	I	Right channel audio input pin
Beep In	11	I	Beep signal input pin
Left In	12	I	Left channel audio input pin
Left Dock	13	O	Right docking output pin
Left Out +	15	O	Left channel positive output pin
Left Out -	17	O	Left channel negative output pin
Left Gain 2	18		Connect pin 2 of the external gain setting resistor for left channel
Left Gain 1	19		Connect pin 1 of the external gain setting resistor for left channel
HP Sense	21	I	Headphone sense control pin
Bypass	22		Bypass pin
Right Gain 1	24		Connect pin 1 of the external gain setting resistor for right channel
Right Gain 2	25		Connect pin 2 of the external gain setting resistor for right channel
Right Out -	26	O	Right channel negative output pin
Right Out +	28	O	Right channel positive output pin

Truth Table for Logic Inputs

Mute	Mode	HP Sense	DC Vol. Control	Bridged Output	Single-Ended
0	0	0	Fixed Level	Vol. Fixed	-
0	0	1	Fixed Level	Muted	Vol. Fixed
0	1	0	Adjusted	Vol. Changes	-
0	1	1	Adjusted	Muted	Vol. Changed
1	x	x	-	Muted	Muted

Typical Application Circuit

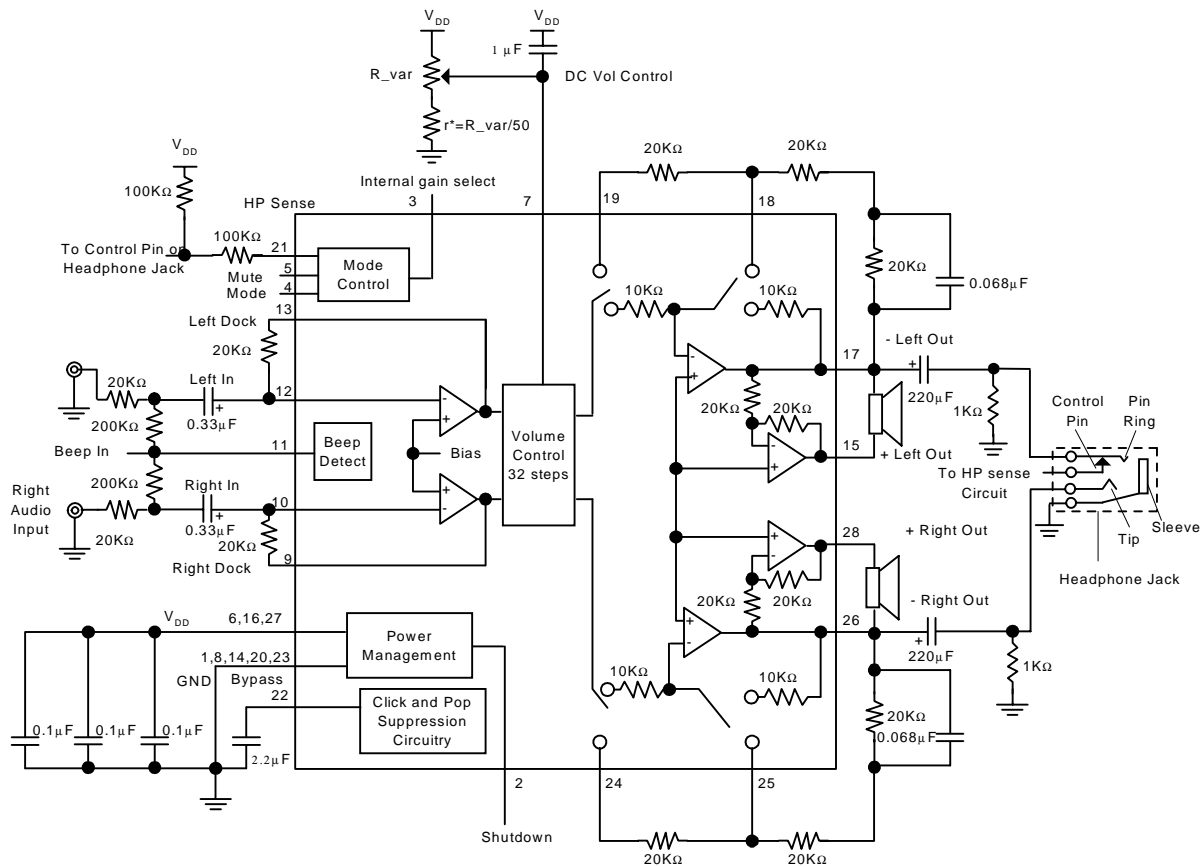

* Add a resistor to avoid volume control gain error at power on status. For the R_var with 10KΩ variable resistor, the recommended value of r is in range of 100~200Ω.

Typical Characteristics

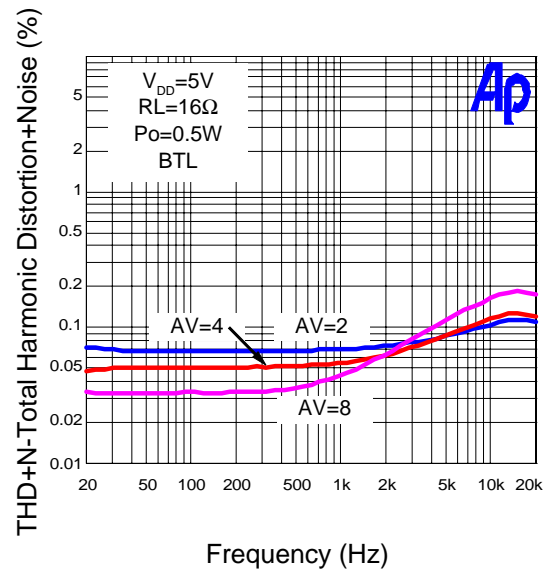
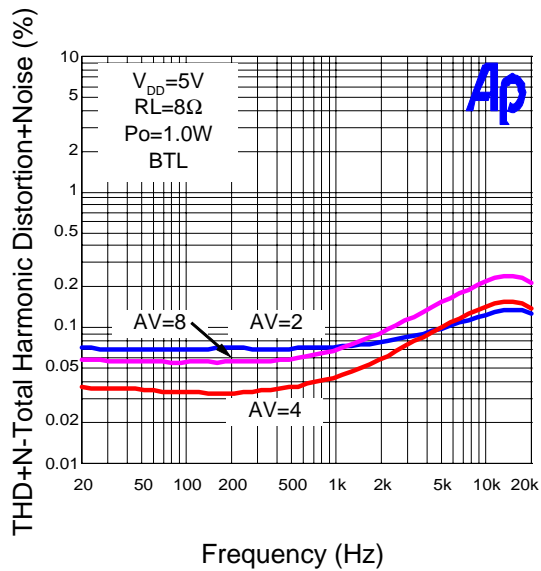
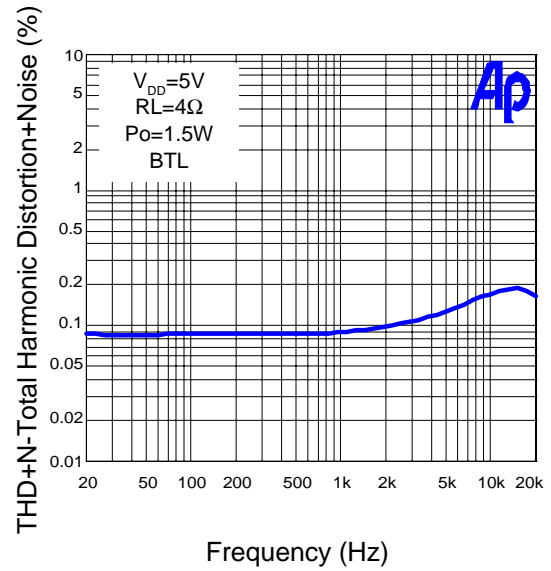
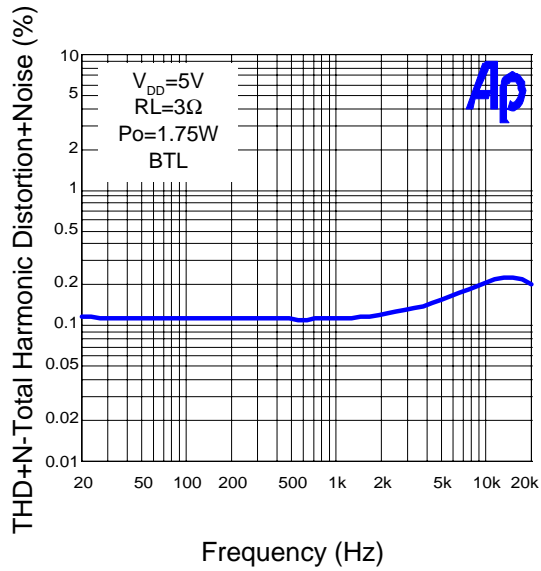

Typical Characteristics Cont.

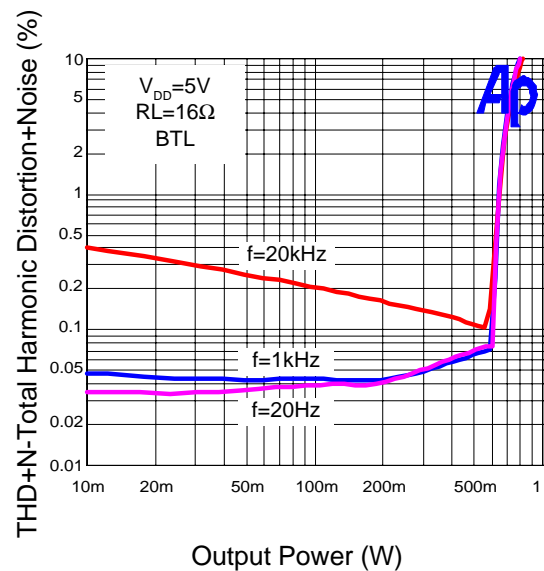
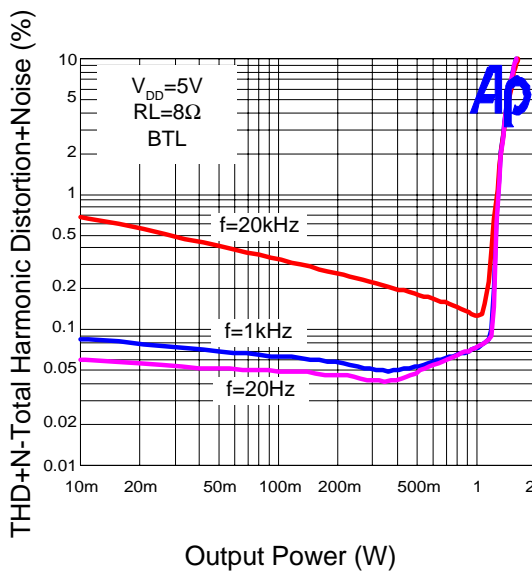
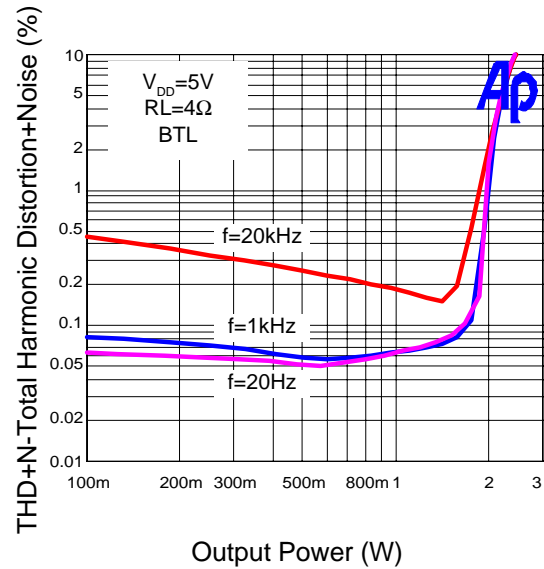
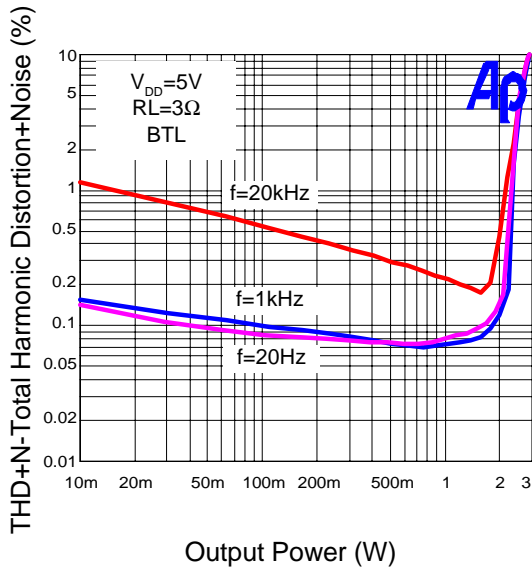

Typical Characteristics Cont.

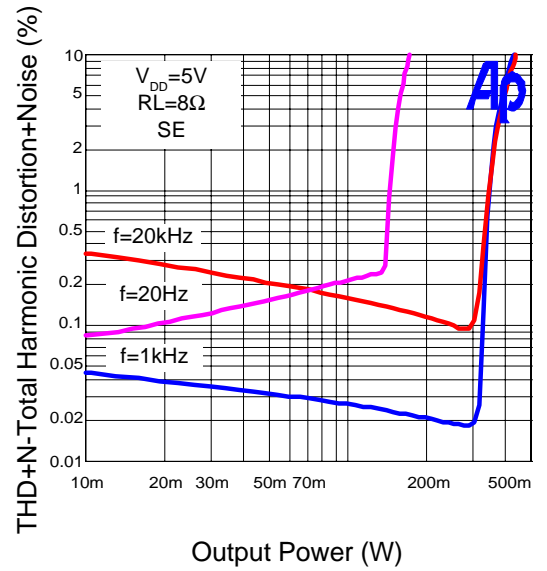
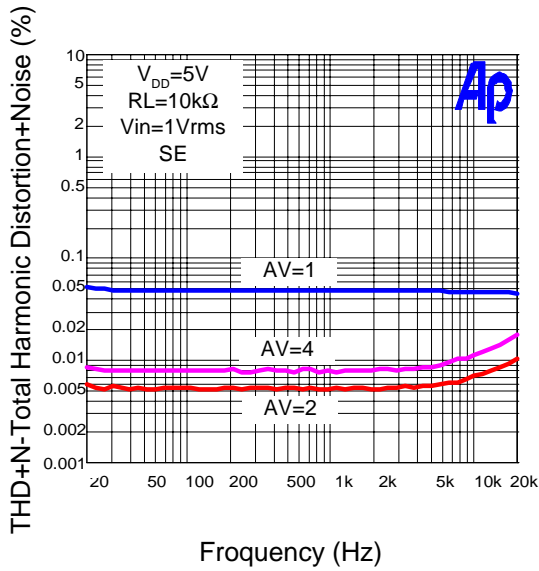
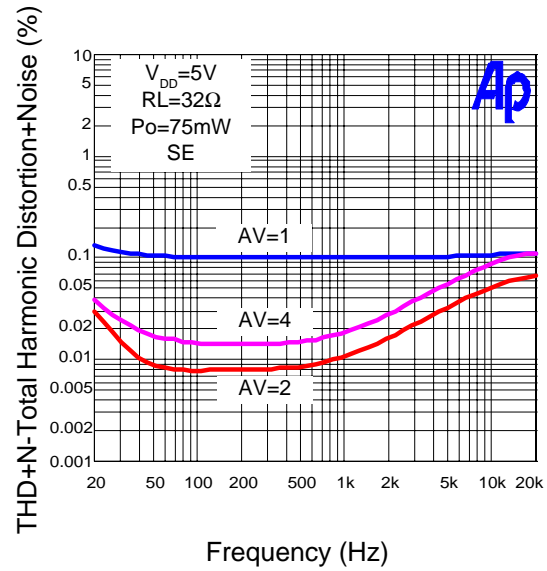
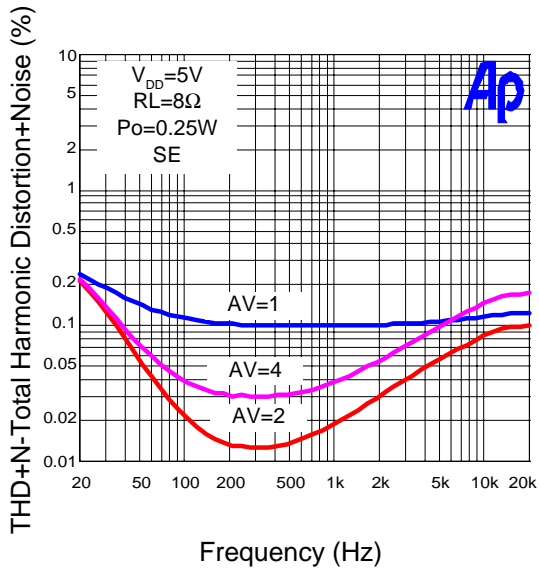

Typical Characteristics Cont.

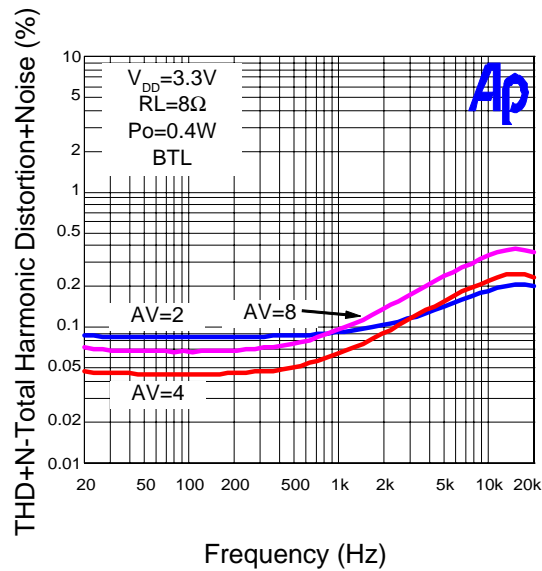
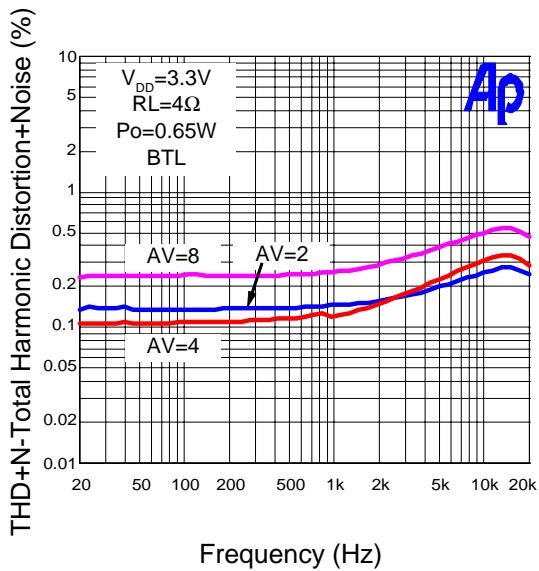
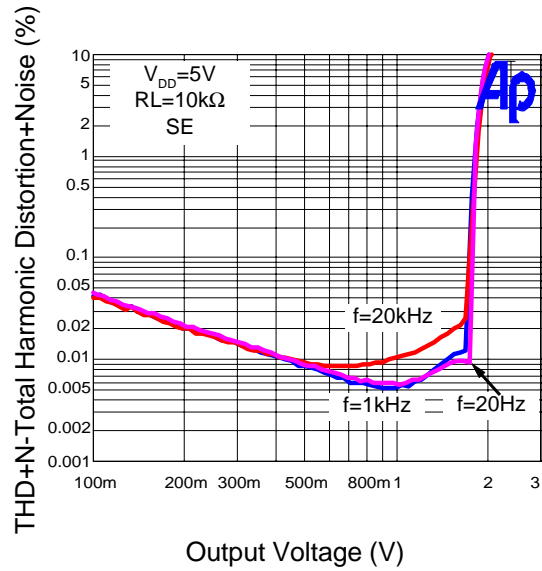
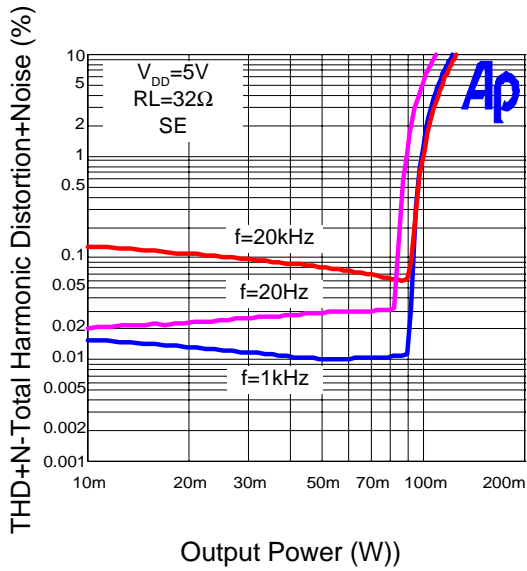

Typical Characteristics Cont.

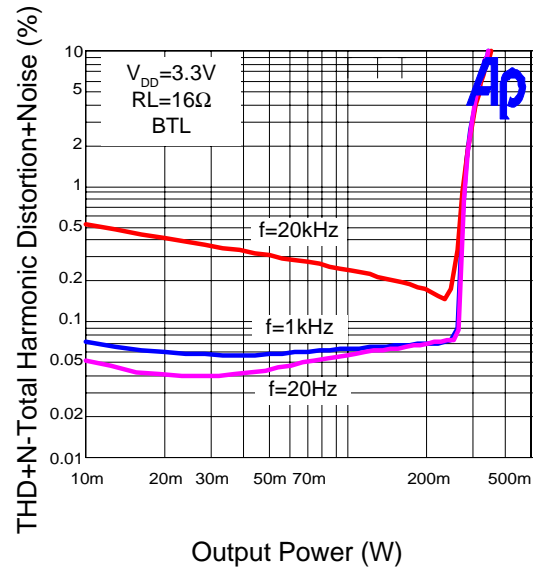
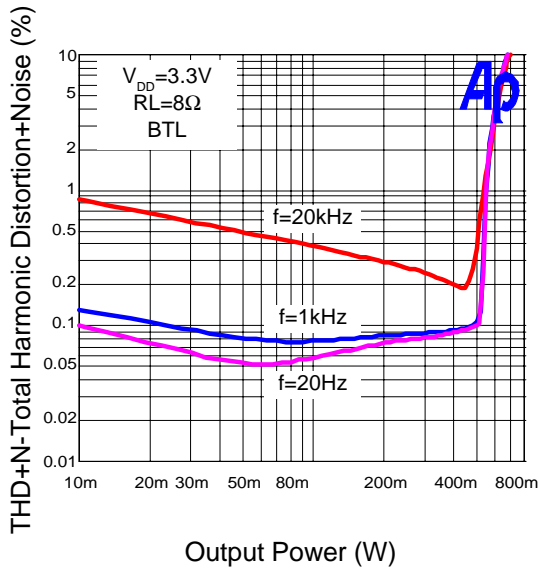
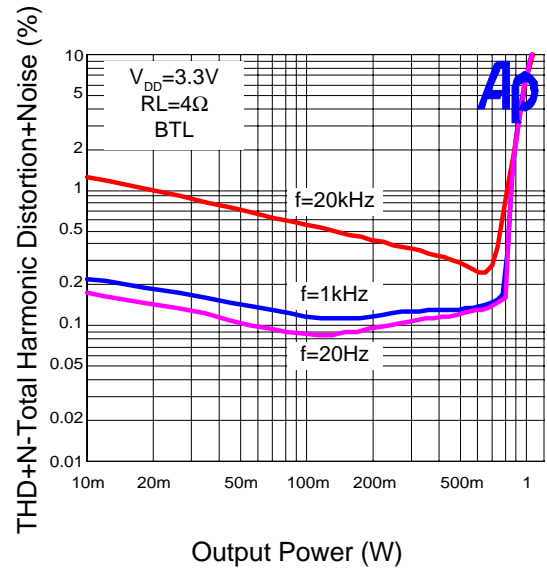
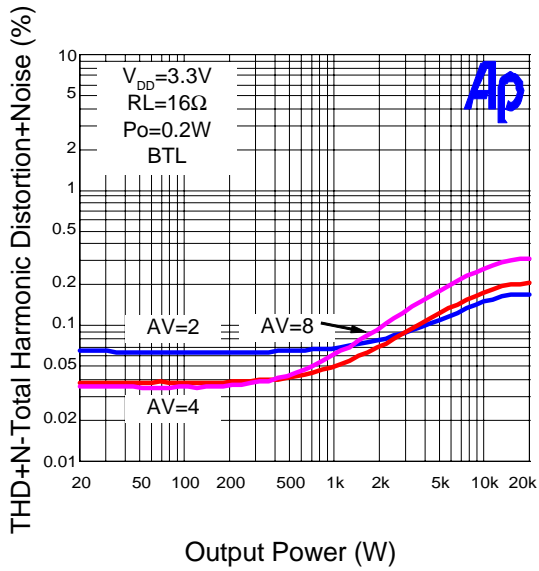

Typical Characteristics Cont.

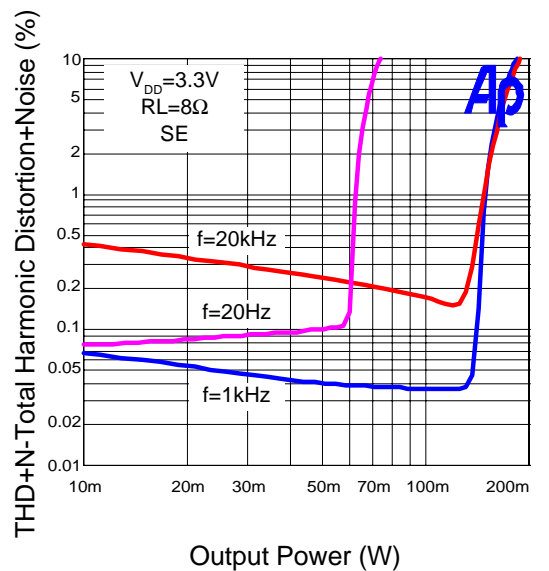
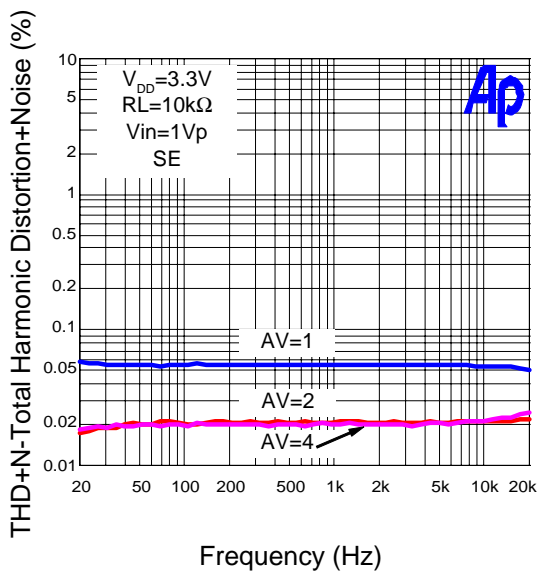
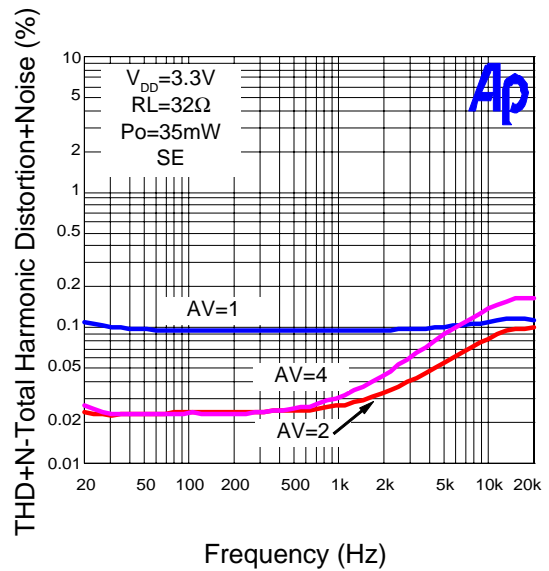
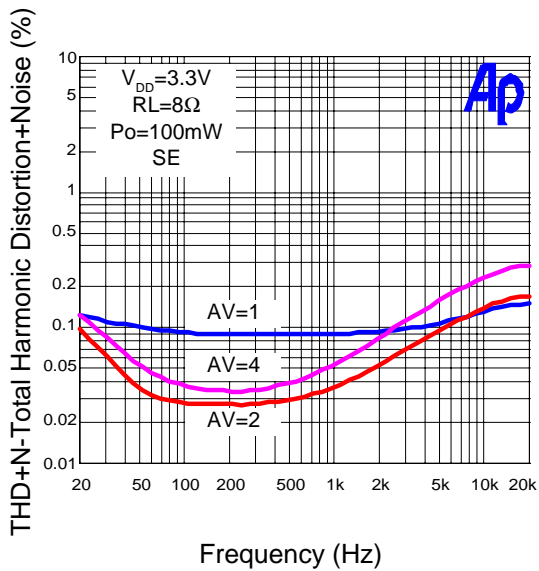

Typical Characteristics Cont.

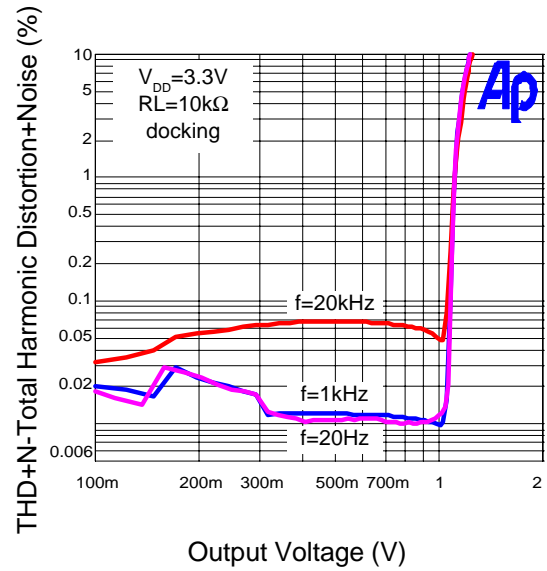
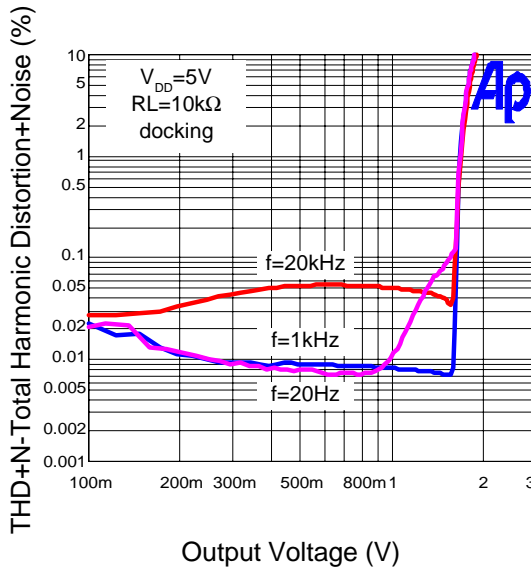
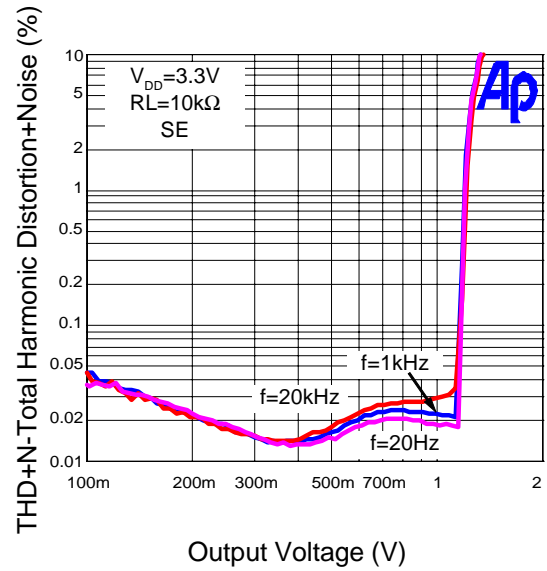
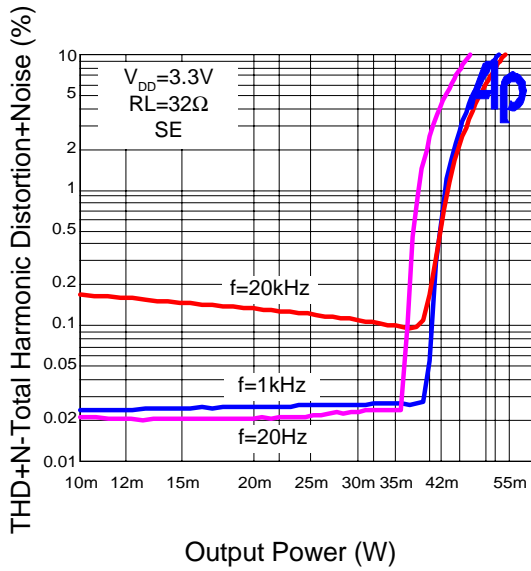

Typical Characteristics Cont.

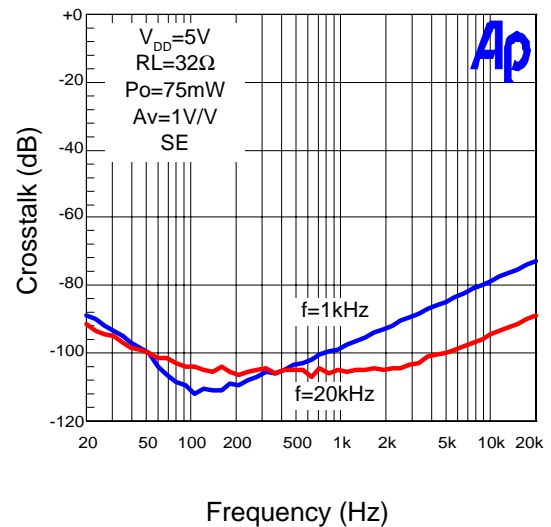
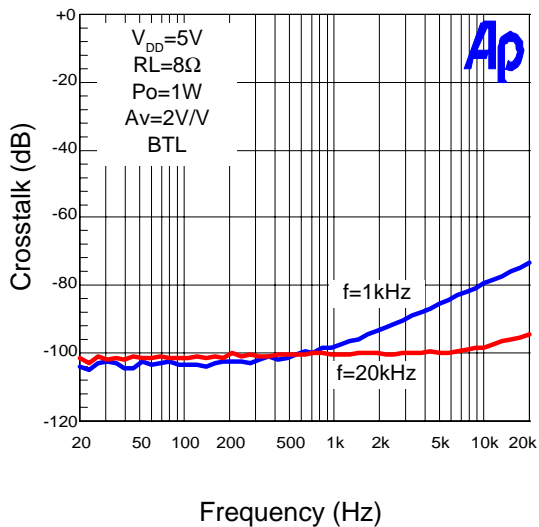
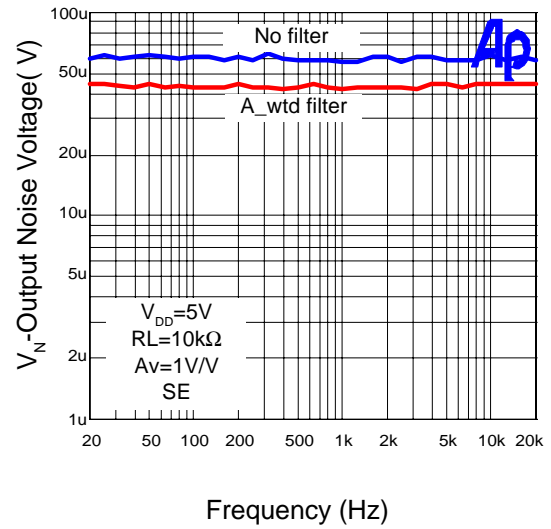
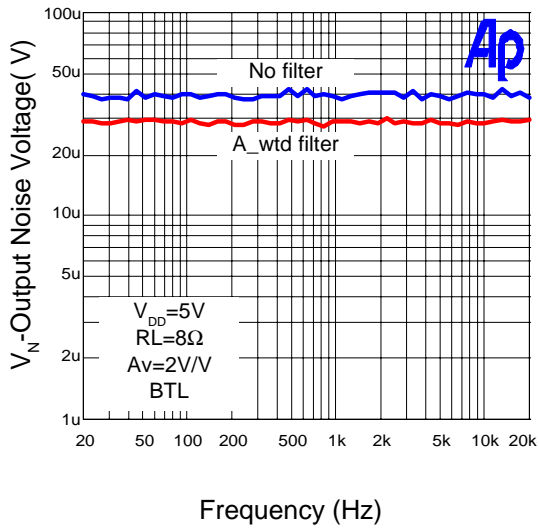

Typical Characteristics Cont.

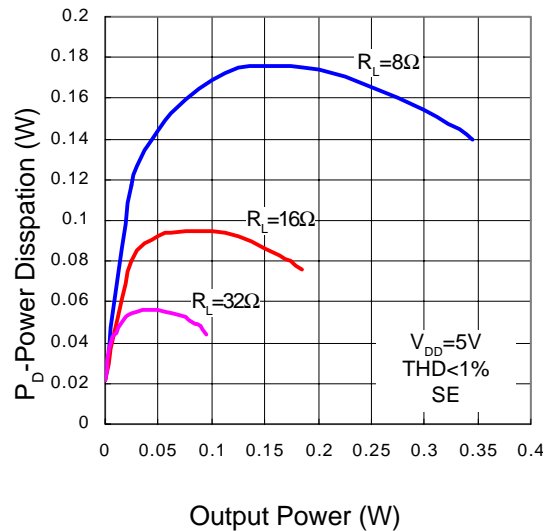
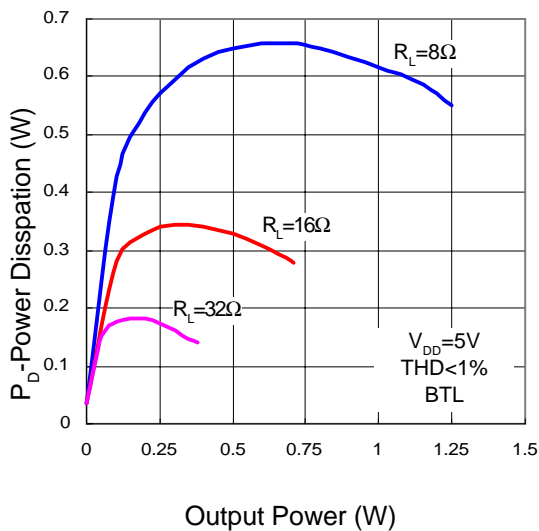
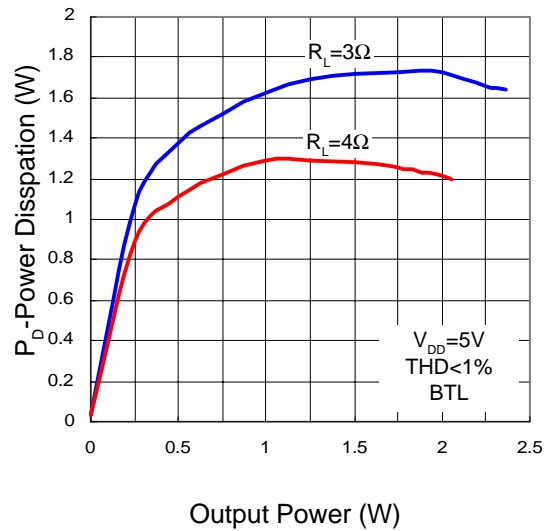
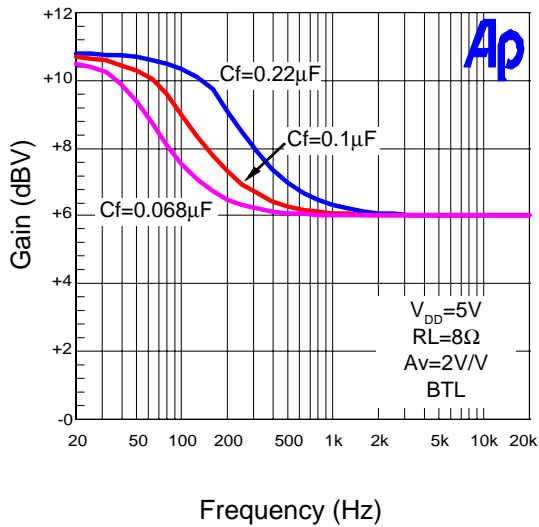

Typical Characteristics Cont.

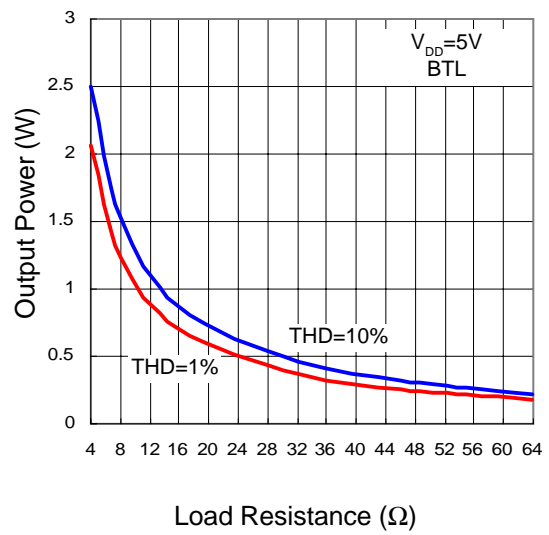
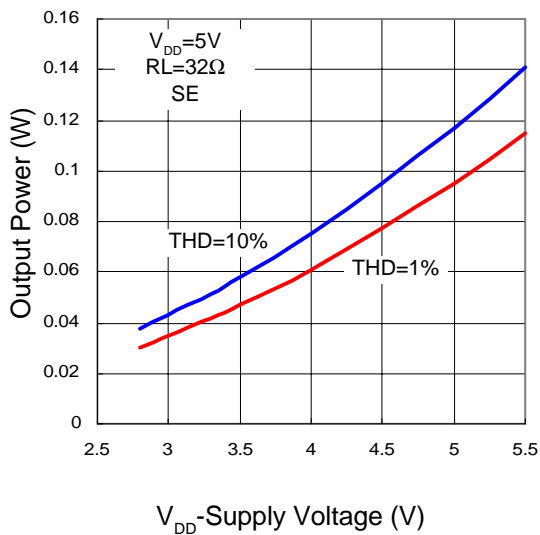
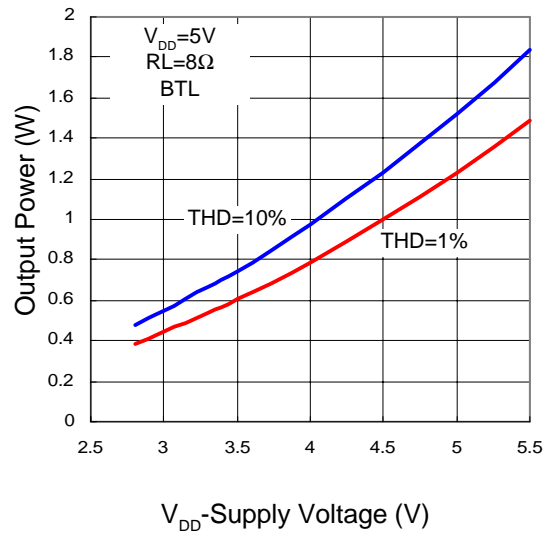
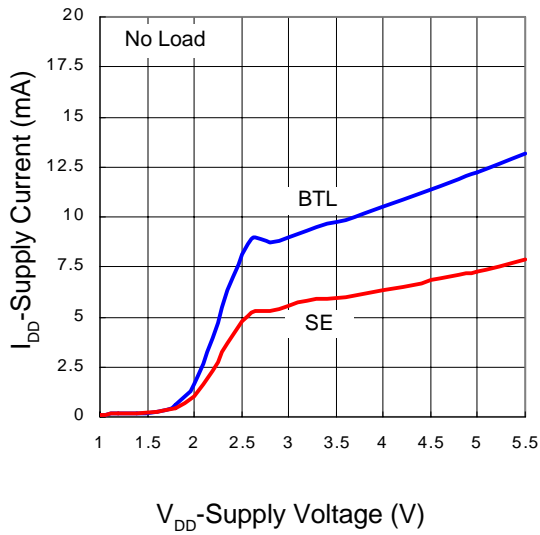

Typical Characteristics Cont.

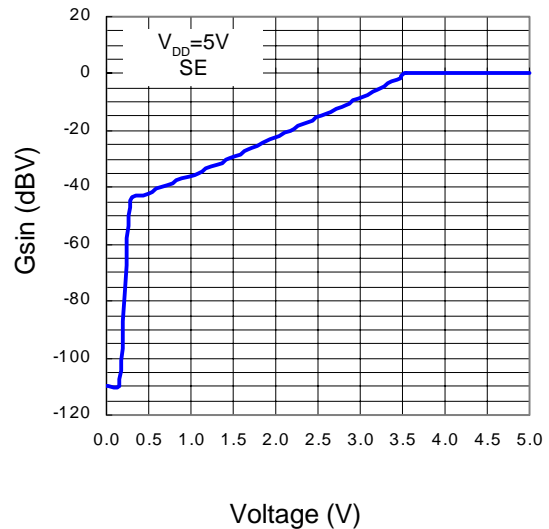
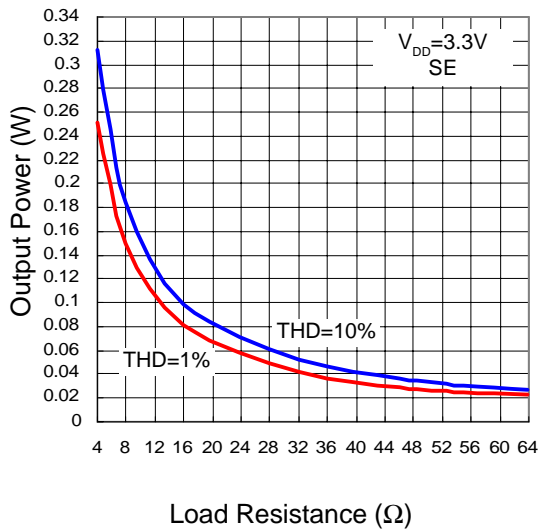
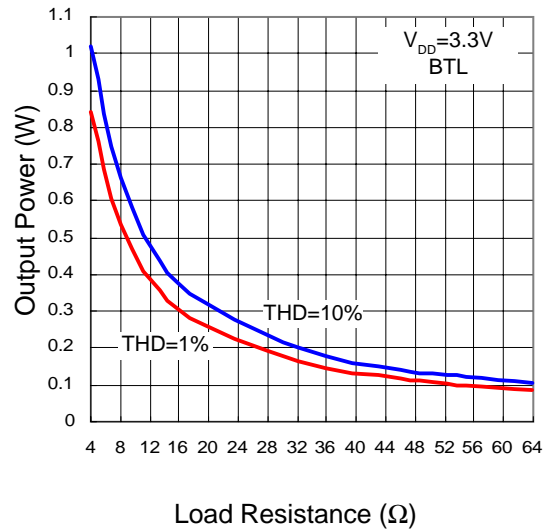
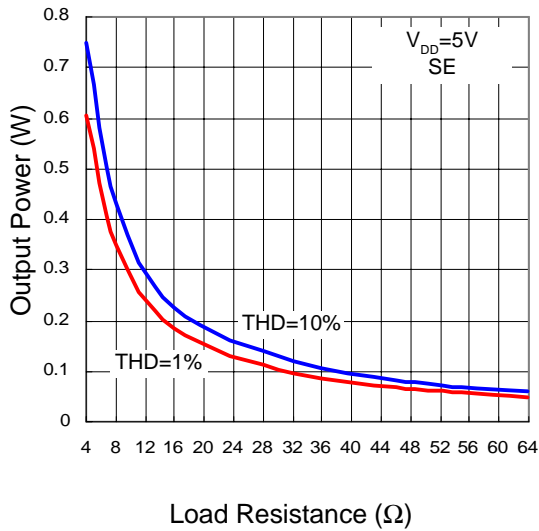

Typical Characteristics Cont.

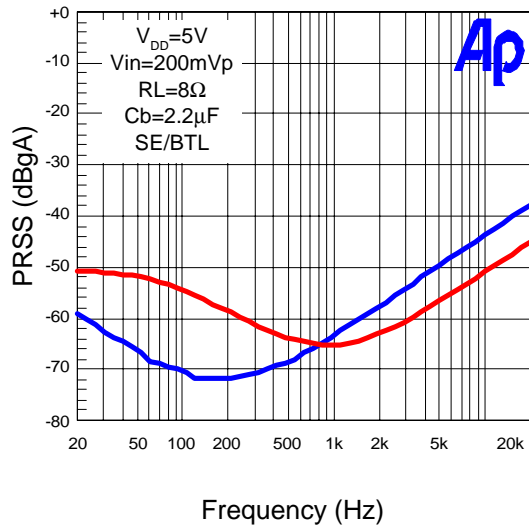

Packaging Information

TSSOP/ TSSOP-P (Reference JEDEC Registration MO-153)

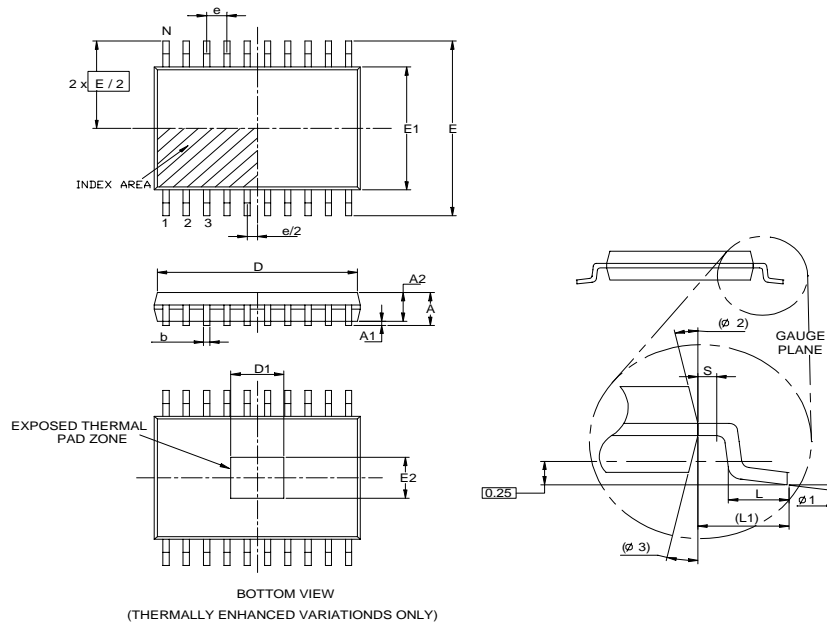

Dim	Millimeters		Inches	
	Min.	Max.	Min.	Max.
A		1.2		0.047
A1	0.00	0.15	0.000	0.006
A2	0.80	1.05	0.031	0.041
b	0.19	0.3	0.007	0.012
D	6.4 (N=20PIN)	6.6 (N=20PIN)	0.252 (N=20PIN)	0.260 (N=20PIN)
	7.7 (N=24PIN)	7.9 (N=24PIN)	0.303 (N=24PIN)	0.311 (N=24PIN)
	9.6 (N=28PIN)	9.8 (N=28PIN)	0.378 (N=28PIN)	0.386 (N=28PIN)
D1	4.2 BSC (N=20PIN)		0.165 BSC (N=20PIN)	
	4.7 BSC (N=24PIN)		0.188 BSC (N=24PIN)	
	3.8 BSC (N=28PIN)		0.150 BSC (N=28PIN)	
e	0.65 BSC		0.026 BSC	
E	6.40 BSC		0.252 BSC	
E1	4.30	4.50	0.169	0.177
E2	3.0 BSC (N=20PIN)		0.118 BSC (N=20PIN)	
	3.2 BSC (N=24PIN)		0.127 BSC (N=24PIN)	
	2.8 BSC (N=28PIN)		0.110 BSC (N=28PIN)	
L	0.45	0.75	0.018	0.030
L1	1.0 REF		0.039 REF	
R	0.09		0.004	
R1	0.09		0.004	
S	0.2		0.008	
$\phi 1$	0°	8°	0°	8°
$\phi 2$	12° REF		12° REF	

Physical Specifications

Terminal Material	Solder-Plated Copper (Solder Material : 90/10 or 63/37 SnPb)
Lead Solderability	Meets EIA Specification RSI86-91, ANSI/J-STD-002 Category 3.

Reflow Condition (IR/Convection or VPR Reflow)

Reference JEDEC Standard J-STD-020A APRIL 1999

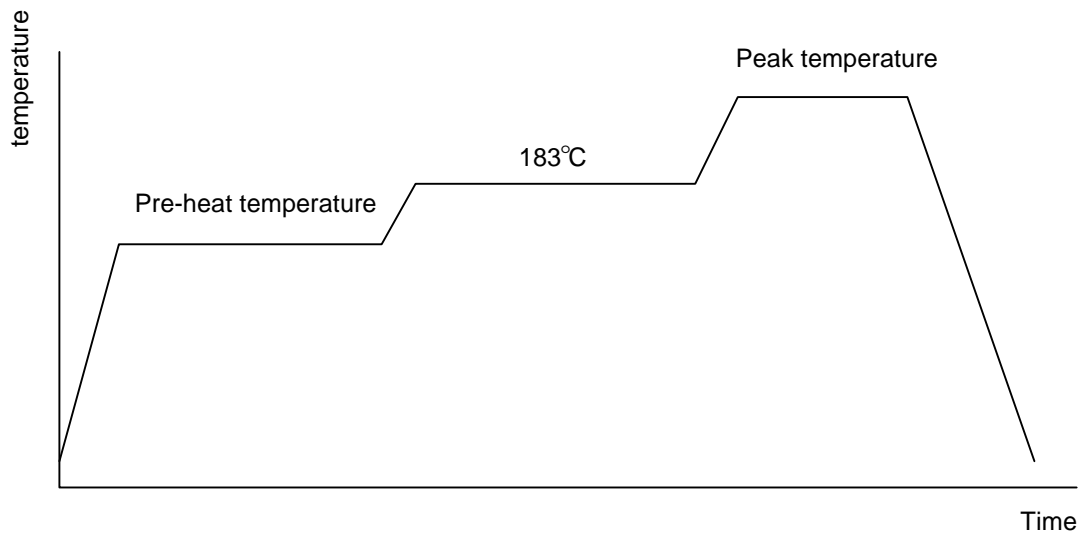

Classification Reflow Profiles

	Convection or IR/ Convection	VPR
Average ramp-up rate(183°C to Peak)	3°C/second max.	10 °C /second max.
Preheat temperature 125 ± 25°C)	120 seconds max	
Temperature maintained above 183°C	60 – 150 seconds	
Time within 5°C of actual peak temperature	10 –20 seconds	60 seconds
Peak temperature range	220 +5/-0°C or 235 +5/-0°C	215-219°C or 235 +5/-0°C
Ramp-down rate	6 °C /second max.	10 °C /second max.
Time 25°C to peak temperature	6 minutes max.	

Package Reflow Conditions

pkg. thickness ≥ 2.5mm and all bgas	pkg. thickness < 2.5mm and pkg. volume ≥ 350 mm ³	pkg. thickness < 2.5mm and pkg. volume < 350mm ³
Convection 220 +5/-0 °C		Convection 235 +5/-0 °C
VPR 215-219 °C		VPR 235 +5/-0 °C
IR/Convection 220 +5/-0 °C		IR/Convection 235 +5/-0 °C

Reliability test program

Test item	Method	Description
SOLDERABILITY	MIL-STD-883D-2003	245°C , 5 SEC
HOLT	MIL-STD-883D-1005.7	1000 Hrs Bias @ 125 °C
PCT	JESD-22-B, A102	168 Hrs, 100 % RH , 121°C
TST	MIL-STD-883D-1011.9	-65°C ~ 150°C, 200 Cycles
ESD	MIL-STD-883D-3015.7	VHBM > 2KV, VMM > 200V
Latch-Up	JESD 78	10ms , $I_{tr} > 100mA$

Carrier Tape & Reel Dimensions

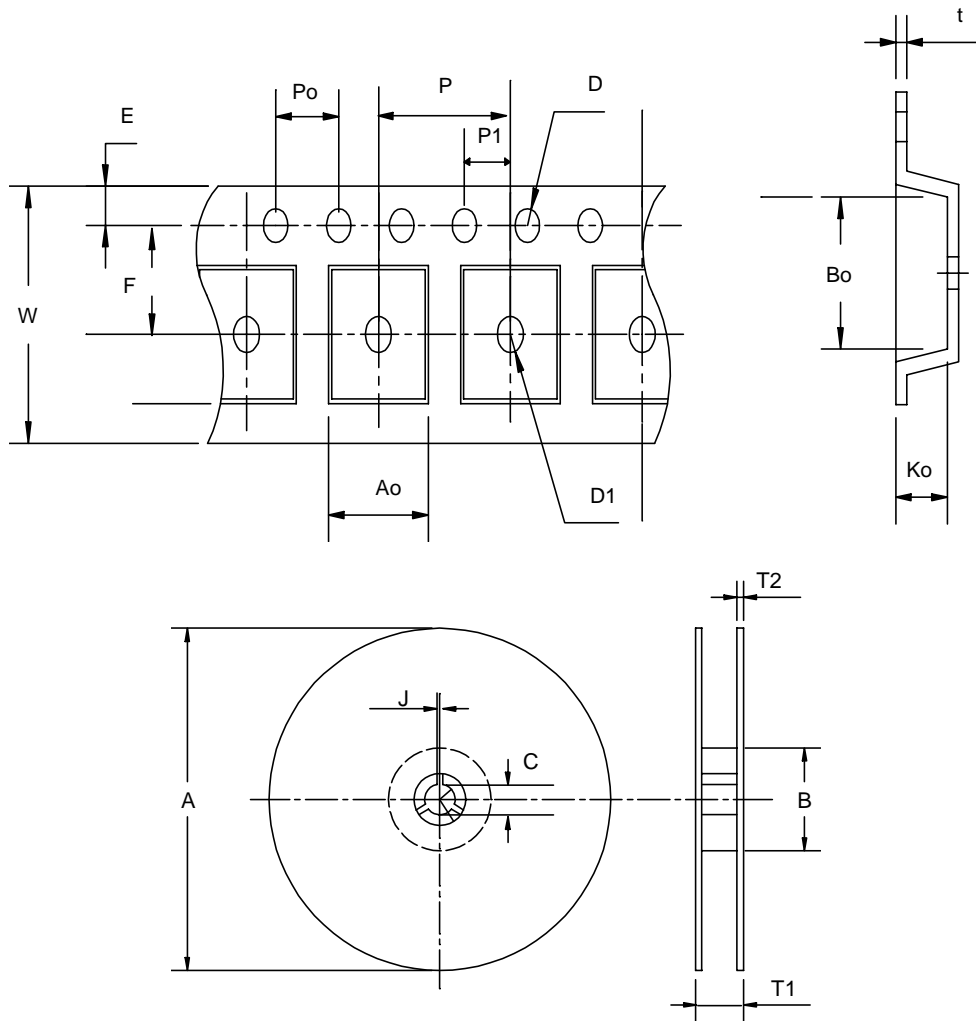

Application	A	B	C	J	T1	T2	W	P	E
TSSOP-20	330 ±1	100 ref	13 ±0.5	2 ±0.5	16.4 ±0.2	2 ±0.2	16 ±0.3	8.0 ±0.1	1.75±0.1
	F	D	D1	Po	P1	Ao	Bo	Ko	t
	7.5 ±0.1	1.5 +0.1	1.5 min	4.0 ±0.1	2.0 ±0.1	6.8 ±0.1	6.9 ±0.1	1.6 ±0.1	0.3±0.05
Application	A	B	C	J	T1	T2	W	P	E
TSSOP-24	330 ±1	100 ref	13 ±0.5	2 ±0.5	16.4 ±0.2	2 ±0.2	16 ±0.3	12 ±0.1	1.75±0.1
	F	D	D1	Po	P1	Ao	Bo	Ko	t
	7.5 ±0.1	1.5 +0.1	1.5 min	4.0 ±0.1	2.0 ±0.1	6.9 ±0.1	8.3 ±0.1	1.5 ±0.1	0.3±0.05
Application	A	B	C	J	T1	T2	W	P	E
TSSOP-28	330 ±1	100 ref	13 ±0.5	2 ±0.5	16.4 ±0.2	2 ±0.2	16 ±0.3	12 ±0.1	1.75±0.1
	F	D	D1	Po	P1	Ao	Bo	Ko	t
	7.5 ±0.1	1.5 +0.1	1.5 min	4.0 ±0.1	2.0 ±0.1	6.9 ±0.1	10.2 ±0.1	1.8 ±0.1	0.3±0.05

(m m)

Cover Tape Dimensions

Application	Carrier Width	Cover Tape Width	Devices Per Reel
TSSOP-20 / 24 / 28	16	21.3	2000

Customer Service

Anpec Electronics Corp.

Head Office :

5F, No. 2 Li-Hsin Road, SBIP,

Hsin-Chu, Taiwan, R.O.C.

Tel : 886-3-5642000

Fax : 886-3-5642050

Taipei Branch :

7F, No. 137, Lane 235, Pac Chiao Rd.,

Hsin Tien City, Taipei Hsien, Taiwan, R. O. C.

Tel : 886-2-89191368

Fax : 886-2-89191369