



# REALTEK

## RTL8100C & RTL8100CL

### SINGLE-CHIP FAST ETHERNET CONTROLLER WITH POWER MANAGEMENT

## DATASHEET

**Rev. 1.06**  
**05 November 2004**  
**Track ID: JATR-1076-21**



**Realtek Semiconductor Corp.**

No. 2, Industry E. Rd. IX, Science-Based Industrial Park, Hsinchu 300, Taiwan

Tel: +886-3-5780211 Fax: +886-3-5776047

[www.realtek.com.tw](http://www.realtek.com.tw)

**COPYRIGHT**

©2004 Realtek Semiconductor Corp. All rights reserved. No part of this document may be reproduced, transmitted, transcribed, stored in a retrieval system, or translated into any language in any form or by any means without the written permission of Realtek Semiconductor Corp.

**DISCLAIMER**

Realtek provides this document “as is”, without warranty of any kind, neither expressed nor implied, including, but not limited to, the particular purpose. Realtek may make improvements and/or changes in this document or in the product described in this document at any time. This document could include technical inaccuracies or typographical errors.

**TRADEMARKS**

Realtek is a trademark of Realtek Semiconductor Corporation. Other names mentioned in this document are trademarks/registered trademarks of their respective owners.

**USING THIS DOCUMENT**

This document provides detailed user guidelines to achieve the best performance when implementing a 2-layer board PC design with the RTL8100C or RTL8100CL Single-Chip Fast Ethernet Controller with Power Management Control.

Though every effort has been made to ensure that this document is current and accurate, more information may have become available subsequent to the production of this guide. In that event, please contact your Realtek representative for additional information that may help in the development process.

**REVISION HISTORY**

Revision	Release Date	Summary
1.01	2003/01/20	First release.
1.02	2003/02/24	Revised pin functions/descriptions. - Add pin description for Pin32. - Pin 45 becomes NC pin. - Pin Reallocation: Reallocate XTAL1 from Pin 125 to Pin 121 (Pin 125 becomes NC pin) - Pin Reallocation: Reallocate XTAL2 from Pin 126 to Pin 122 (Pin126 becomes NC pin) - Pin Reassignment: Pin 123 reassigned to GND - Pin Reassignment: Pin 124 reassigned to GND
1.03	2003/10/30	Add Ordering Information.
1.04	2004/03/30	Pins 64, 88,113 become NC pins (see Table 7, page 9). Revised format
1.05	2004/06/16	Added Lead-Free package part numbers to Ordering Information, page 65.
1.06	2004/11/05	Corrected minor typing errors.

---

## Table of Contents

---

<b>1. GENERAL DESCRIPTION</b> .....	<b>1</b>
<b>2. FEATURES</b> .....	<b>2</b>
<b>3. BLOCK DIAGRAM</b> .....	<b>3</b>
<b>4. PIN ASSIGNMENTS</b> .....	<b>4</b>
4.1. RTL8100C (QFP) & RTL8100CL (LQFP).....	4
<b>5. PIN DESCRIPTION</b> .....	<b>5</b>
5.1. POWER MANAGEMENT/ISOLATION INTERFACE .....	5
5.2. PCI INTERFACE .....	6
5.3. EPROM/EEPROM INTERFACE/AUX .....	8
5.4. POWER PINS .....	8
5.5. LED INTERFACE.....	8
5.6. ATTACHMENT UNIT INTERFACE .....	9
5.7. TEST AND OTHER PINS .....	9
5.8. REGISTER DESCRIPTIONS.....	10
5.9. RECEIVE STATUS REGISTER IN RX PACKET HEADER .....	12
5.10. TRANSMIT STATUS REGISTER (TSD0-3)(OFFSET 0010H-001FH, R/W) .....	13
5.11. ERSR: EARLY RX STATUS REGISTER (OFFSET 0036H, R) .....	14
5.12. COMMAND REGISTER (OFFSET 0037H, R/W).....	15
5.13. INTERRUPT MASK REGISTER (OFFSET 003CH-003DH, R/W).....	15
5.14. INTERRUPT STATUS REGISTER (OFFSET 003EH-003FH, R/W) .....	16
5.15. TRANSMIT CONFIGURATION REGISTER (OFFSET 0040H-0043H, R/W).....	17
5.16. RECEIVE CONFIGURATION REGISTER (OFFSET 0044H-0047H, R/W).....	19
5.17. 9346CR: 93C46 COMMAND REGISTER (OFFSET 0050H, R/W).....	22
5.18. CONFIG 0: CONFIGURATION REGISTER 0 (OFFSET 0051H, R/W).....	23
5.19. CONFIG 1: CONFIGURATION REGISTER 1 (OFFSET 0052H, R/W).....	23
5.20. MEDIA STATUS REGISTER (OFFSET 0058H, R/W).....	24
5.21. CONFIG 3: CONFIGURATION REGISTER3 (OFFSET 0059H, R/W).....	25
5.22. CONFIG 4: CONFIGURATION REGISTER4 (OFFSET 005AH, R/W).....	27
5.23. MULTIPLE INTERRUPT SELECT REGISTER (OFFSET 005CH-005DH, R/W).....	28

5.24.	PCI REVISION ID (OFFSET 005EH, R).....	28
5.25.	TRANSMIT STATUS OF ALL DESCRIPTORS (TSAD) REGISTER (OFFSET 0060H-0061H, R/W) .....	28
5.26.	BASIC MODE CONTROL REGISTER (OFFSET 0062H-0063H, R/W).....	29
5.27.	BASIC MODE STATUS REGISTER (OFFSET 0064H-0065H, R).....	29
5.28.	AUTO-NEGOTIATION ADVERTISEMENT REGISTER (OFFSET 0066H-0067H, R/W) .....	30
5.29.	AUTO-NEGOTIATION LINK PARTNER ABILITY REGISTER (OFFSET 0068H-0069H, R) .....	31
5.30.	AUTO-NEGOTIATION EXPANSION REGISTER (OFFSET 006AH-006BH, R) .....	32
5.31.	DISCONNECT COUNTER .....	32
5.32.	FALSE CARRIER SENSE COUNTER (OFFSET 006EH-006FH, R) .....	32
5.33.	NWAY TEST REGISTER (OFFSET 0070H-0071H, R/W).....	33
5.34.	RX_ER COUNTER (OFFSET 0072H-0073H, R) .....	33
5.35.	CS CONFIGURATION REGISTER (OFFSET 0074H-0075H, R/W) .....	33
5.36.	CONFIG5: CONFIGURATION REGISTER 5 (OFFSET 00D8H, R/W).....	34
5.37.	EEPROM (93C46) CONTENTS .....	35
5.38.	RTL8100C(L) EEPROM REGISTERS SUMMARY .....	37
5.39.	EEPROM POWER MANAGEMENT REGISTERS SUMMARY .....	37
<b>6.</b>	<b>PCI CONFIGURATION SPACE REGISTERS.....</b>	<b>38</b>
6.1.	PCI CONFIGURATION SPACE TABLE.....	38
6.2.	PCI CONFIGURATION SPACE FUNCTIONS .....	39
6.3.	PCI CONFIGURATION SPACE STATUS .....	41
6.4.	DEFAULT VALUES AFTER POWER-ON (RSTB ASSERTED).....	44
6.5.	PCI POWER MANAGEMENT FUNCTIONS.....	45
6.5.1.	Power Down Mode .....	45
6.6.	VPD (VITAL PRODUCT DATA).....	48
<b>7.</b>	<b>FUNCTIONAL DESCRIPTION.....</b>	<b>49</b>
7.1.	TRANSMIT OPERATION .....	49
7.2.	RECEIVE OPERATION.....	49
7.3.	WANDER COMPENSATION .....	49
7.4.	SIGNAL DETECT .....	49
7.5.	LINE QUALITY MONITOR .....	50
7.6.	CLOCK RECOVERY MODULE .....	50
7.7.	LOOPBACK OPERATION .....	50
7.8.	TX ENCAPSULATION.....	50
7.9.	COLLISION.....	50

7.10. RX DECAPSULATION .....	51
7.11. FLOW CONTROL .....	51
7.11.1. Control Frame Transmission.....	51
7.11.2. Control Frame Reception.....	51
7.12. LED FUNCTIONS.....	52
7.12.1. 10/100Mbps Link Monitor.....	52
7.12.2. LED_RX.....	52
7.12.3. LED_TX.....	53
7.12.4. LED_TX+LED_RX.....	53
<b>8. CHARACTERISTICS .....</b>	<b>54</b>
8.1. THERMAL CHARACTERISTICS .....	54
8.2. DC CHARACTERISTICS .....	54
8.2.1. Supply Voltage ( $V_{cc} = 3.0V$ min. to $3.6V$ max.).....	54
8.2.2. Supply Voltage ( $V_{dd25} = 2.3V$ min. to $2.7V$ max.).....	54
8.3. AC CHARACTERISTICS .....	55
8.3.1. PCI Bus Operation Timing.....	55
<b>9. APPLICATION INFORMATION .....</b>	<b>61</b>
<b>10. MECHANICAL DIMENSIONS .....</b>	<b>62</b>
10.1. RTL8100C 128-PIN QFP.....	62
10.2. NOTES FOR RTL8100C 128-PIN QFP .....	63
10.3. RTL8100CL 128-PIN LQFP.....	64
10.4. NOTES FOR RTL8100CL 128-PIN LQFP .....	65
<b>11. ORDERING INFORMATION .....</b>	<b>65</b>

## List of Tables

Table 1. Power Management/Isolation Interface .....	5
Table 2. PCI Interface .....	6
Table 3. EPROM/EEPROM Interface/AUX .....	8
Table 4. Power Pins .....	8
Table 5. LED Interface .....	8
Table 6. Attachment Unit Interface.....	9
Table 7. Test and Other Pins .....	9
Table 8. Register Descriptions.....	10
Table 9. Receive Status Register in RX Packet Header.....	12
Table 10. Transmit Status Register .....	13
Table 11. ERSR: Early RX Status Register .....	14
Table 12. Command Register.....	15
Table 13. Interrupt Mask Register .....	15
Table 14. Interrupt Status Register .....	16
Table 15. Transmit Configuration Register .....	17
Table 16. Receive Configuration Register.....	19
Table 17. 9346CR: 93C46 Command Register .....	22
Table 18. CONFIG 0: Configuration Register 0.....	23
Table 19. CONFIG 1: Configuration Register 1.....	23
Table 20. Media Status Register .....	24
Table 21. CONFIG 3: Configuration Register3.....	25
Table 22. CONFIG 4: Configuration Register4.....	27
Table 23. Multiple Interrupt Select Register .....	28
Table 24. PCI Revision ID.....	28
Table 25. Transmit Status of All Descriptors (TSAD) Register .....	28
Table 26. Basic Mode Control Register.....	29
Table 27. Basic Mode Status Register .....	29
Table 28. Auto-Negotiation Advertisement Register.....	30
Table 29. Auto-Negotiation Link Partner Ability Register.....	31
Table 30. Auto-Negotiation Expansion Register .....	32
Table 31. Disconnect Counter.....	32
Table 32. False Carrier Sense Counter .....	32
Table 33. NWay Test Register.....	33

---

Table 34. RX_ER Counter .....	33
Table 35. CS Configuration Register.....	33
Table 36. Config5. Configuration Register 5.....	34
Table 37. EEPROM (93C46) Contents.....	35
Table 38. RTL8100C(L) EEPROM Registers Summary .....	37
Table 39. EEPROM Power Management Registers Summary .....	37
Table 40. PCI Configuration Space Table .....	38
Table 41. PCI Configuration Space Functions .....	40
Table 42. PCI Configuration Space Status.....	41
Table 43. Base IO Address.....	42
Table 44. Base Memory Address for Memory Accesses .....	43
Table 45. Default Values after Power-On (RSTB Asserted).....	44
Table 46. Thermal Characteristics .....	54
Table 47. Supply Voltage (3.0V min. to 3.6V max.).....	54
Table 48. Supply Voltage (2.3V min. to 2.7V max.).....	54

---

---

## List of Figures

---

Figure 1. Block Diagram .....	3
Figure 2. Pin Assignments .....	4
Figure 3. LED_RX.....	52
Figure 4. LED_TX.....	53
Figure 5. LED_TX+LED_RX .....	53
Figure 6. Target Read.....	55
Figure 7. Target Write .....	55
Figure 8. Configuration Read .....	56
Figure 9. Configuration Write.....	56
Figure 10. Bus Arbitration .....	57
Figure 11. Memory Read .....	57
Figure 12. Memory Write .....	58
Figure 13. Target Initiated Termination - Retry.....	58
Figure 14. Target Initiated Termination - Disconnect.....	59
Figure 15. Target Initiated Termination - Abort.....	59
Figure 16. Master Initiated Termination – Abort.....	60
Figure 17. Parity Operation - One Example .....	60
Figure 18. Application Information .....	61

---



## 1. General Description

The Realtek RTL8100C(L) is a highly integrated, cost-effective single-chip Fast Ethernet controller that provides 32-bit performance, PCI bus master capability, and full compliance with IEEE 802.3u 100Base-T specifications and IEEE 802.3x Full Duplex Flow Control. It also supports the Advanced Configuration and Power Interface (ACPI), PCI power management for modern operating systems that are capable of Operating System-Directed Power Management (OSPM) to achieve the most efficient power management possible. The RTL8100C(L) does not support CardBus mode (the RTL8139C does).

In addition to the ACPI feature, the RTL8100C(L) also supports remote wake-up (including AMD Magic Packet, LinkChg, and Microsoft® wake-up frame) in both ACPI and APM (Advanced Power Management) environments. The RTL8100C(L) is capable of performing an internal reset through the application of auxiliary power. When auxiliary power is applied and the main power remains off, the RTL8100C(L) is ready and waiting for a Magic Packet or Link Change to wake the system up. Also, the LWAKE pin provides 4 output signals (active high, active low, positive pulse, and negative pulse). The versatility of the RTL8100C(L) LWAKE pin provides motherboards with Wake-On-LAN (WOL) functionality.

The RTL8100C(L) also supports Analog Auto-Power-down. The analog part of the RTL8100C(L) can be shut down temporarily according to user requirements, or when the RTL8100C(L) is in a power down state with the wakeup function disabled. When the analog part is shut down and the IsolateB pin is low (i.e. the main power is off), both the analog and digital parts stop functioning and the power consumption of the RTL8100C(L) is negligible. The RTL8100C(L) also supports an auxiliary power auto-detect function, and will auto-configure related bits of its PCI power management registers in PCI configuration space.

PCI Vital Product Data (VPD) is also supported to provide hardware identifier information. The information may consist of part number, serial number, OEM brand name, and other detailed information.

To provide cost down support, the RTL8100C(L) is capable of using a 25MHz crystal or OSC as its internal clock source.

The RTL8100C(L) keeps network maintenance costs low and eliminates usage barriers. It is the easiest way to upgrade a network from 10 to 100Mbps. It also supports full-duplex operation, making 200Mbps bandwidth possible at no additional cost. To improve compatibility with other brands' products, the RTL8100C(L) is also capable of receiving packets with an InterFrame Gap equal to or more than 40-bit time. The RTL8100C(L) is highly integrated and requires no glue logic or external memory.

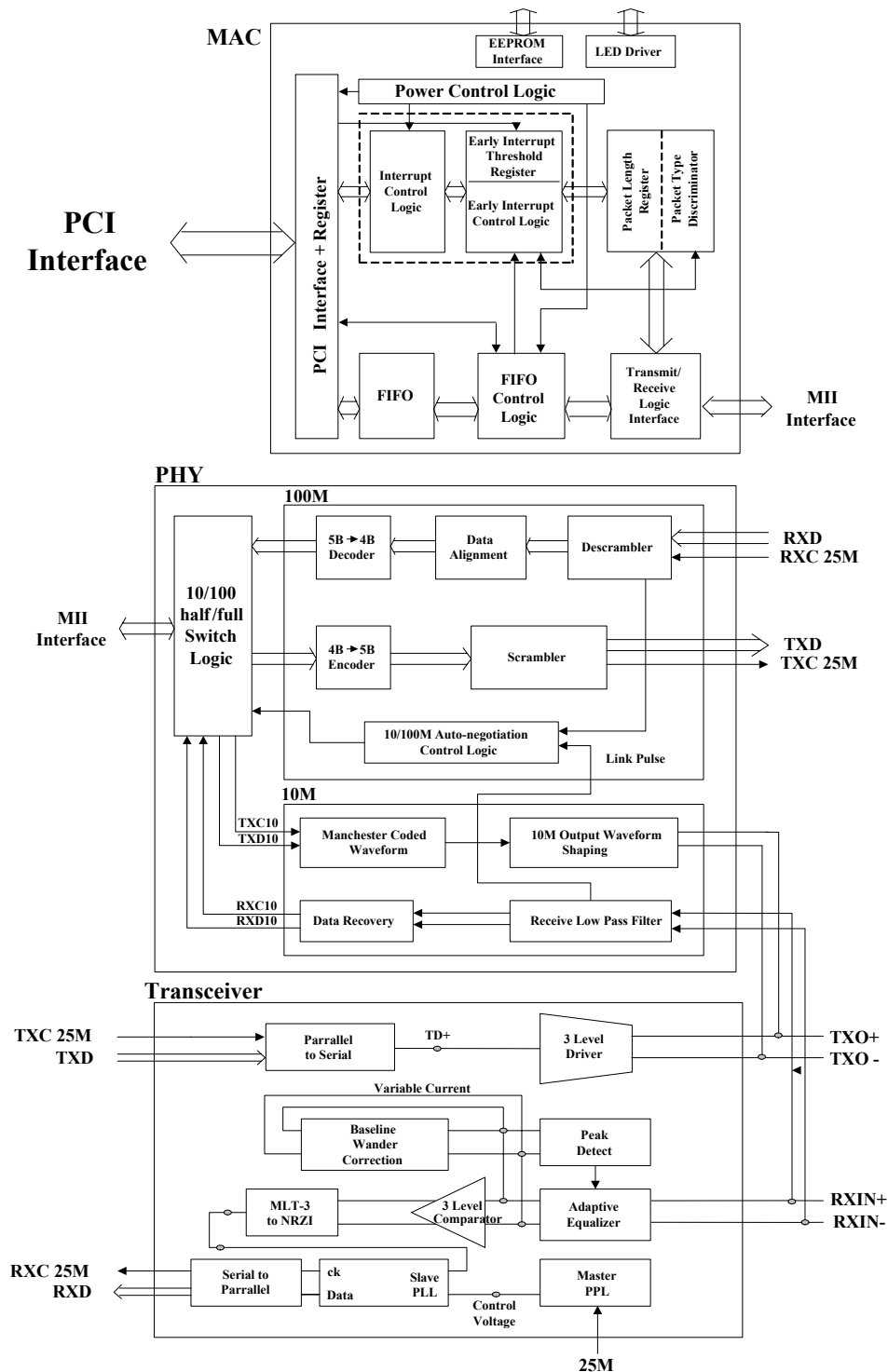
## 2. Features

- 128-pin QFP/LQFP
- Integrated Fast Ethernet MAC, Physical chip, and transceiver in one chip
- 10Mbps and 100Mbps operation
- Supports 10Mbps and 100Mbps NWay auto-negotiation
- PCI local bus single-chip Fast Ethernet controller
  - ◆ Complies with PCI Revision 2.2
  - ◆ Supports PCI clock 16.75MHz-40MHz
  - ◆ Supports PCI target fast back-to-back transaction
  - ◆ Provides PCI bus master data transfers and PCI memory space or I/O space mapped data transfers of the RTL8100C(L)'s operational registers
  - ◆ Supports PCI VPD (Vital Product Data)
  - ◆ Supports ACPI, PCI power management
- Supports 25MHz crystal or 25MHz OSC as the internal clock source. The frequency deviation of either crystal or OSC must be within 50PPM.
- Complies with the PC99/PC2001 standard
- Supports Wake-On-LAN and remote wake-up (Magic Packet\*, LinkChg, and Microsoft® wake-up frame)
- Supports 4 Wake-On-LAN (WOL) signals (active high, active low, positive pulse, and negative pulse)
- Supports auxiliary power-on internal reset, to be ready for remote wake-up when main power remains off
- Supports auxiliary power auto-detect, and sets the related capability of power management registers in PCI configuration space
- Includes programmable PCI burst size and early Tx/Rx threshold
- Supports a 32-bit general-purpose timer, with the external PCI clock as clock source, for generating timer-interrupts
- Contains two (2Kbyte) independent receive and transmit FIFOs
- Advanced power saving mode when LAN and wakeup function are not used
- Uses 93C46 (64\*16-bit EEPROM) to store resource configuration, ID parameter, and VPD data
- Supports LED pins for various network activity indications
- Supports loopback capability
- Half/Full duplex capability
- Supports Full Duplex Flow Control (IEEE 802.3x)
- 2.5/3.3V power supply with 5V tolerant I/Os.
- 0.25μm CMOS process

\* Third-party brands and names are the property of their respective owners.

*Note: The QFP package model number is RTL8100C. The LQFP package model number is RTL8100CL.*

### 3. Block Diagram



**Figure 1. Block Diagram**

## 4. Pin Assignments

### 4.1. RTL8100C (QFP) & RTL8100CL (LQFP)

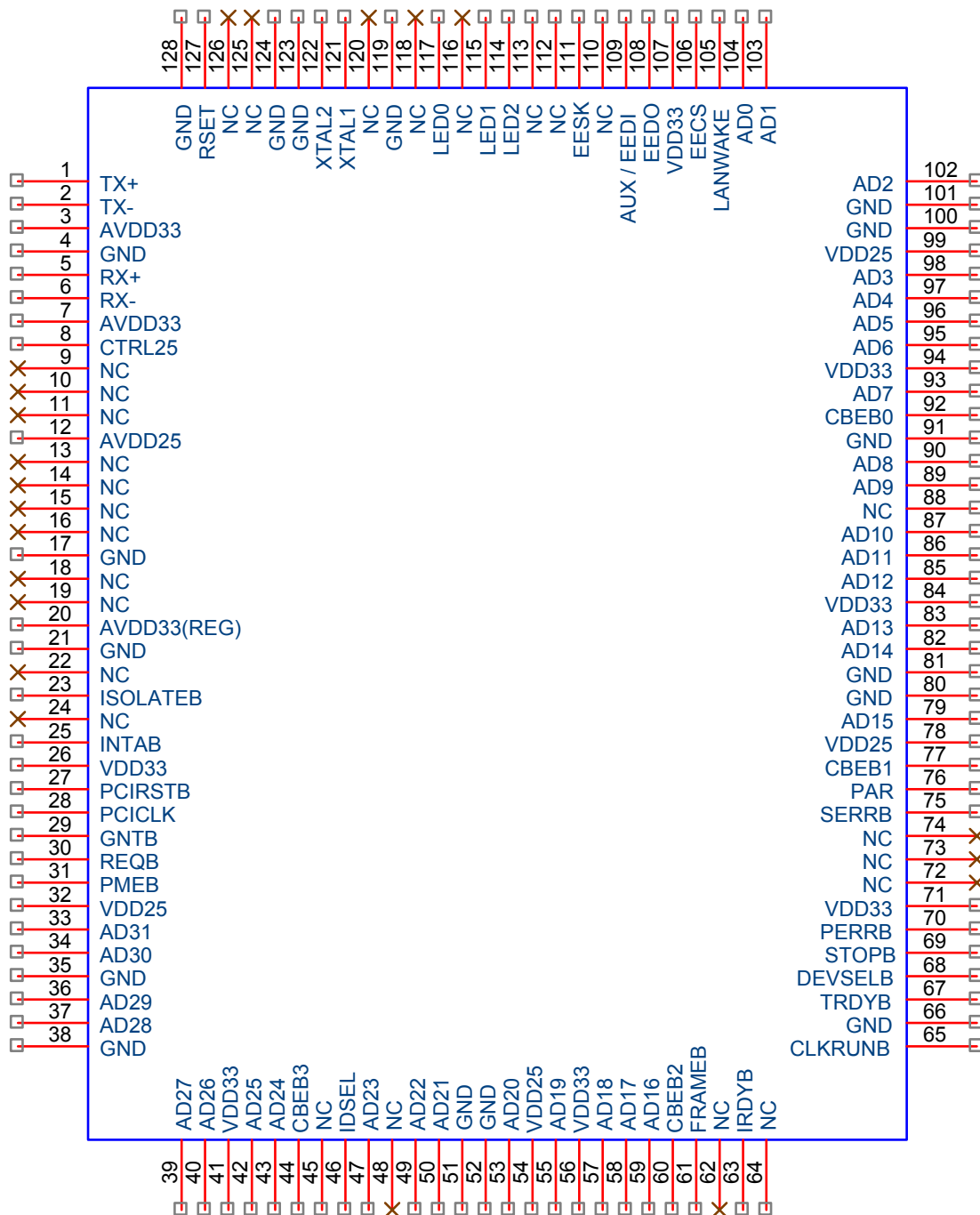


Figure 2. Pin Assignments

## 5. Pin Description

### 5.1. Power Management/Isolation Interface

The following signal type codes are used in the tables:

I: Input.

O: Output.

T/S: Tri-State bi-directional input/output pin.

S/T/S: Sustained Tri-State.

O/D: Open Drain.

**Table 1. Power Management/Isolation Interface**

Symbol	Type	Pin No	Description
PMEB (PME#)	O/D	31	Power Management Event. Open drain, active low. Used by the RTL8100C(L) to request a change in its current power management state and/or to indicate that a power management event has occurred.
ISOLATEB (ISOLATE#)	I	23	Isolate Pin: Active low. Isolates the RTL8100C(L) from the PCI bus. The RTL8100C(L) does not drive its PCI outputs (excluding PME#) and does not sample its PCI input (including RST# and PCICLK) as long as the Isolate pin is asserted.
LWAKE	O	105	LAN WAKE-UP Signal. Signals to the motherboard that it should execute the wake-up process. The motherboard must support Wake-On-LAN (WOL). There are 4 output choices, active high, active low, positive pulse, and negative pulse, that may be asserted from the LWAKE pin. See the LWACT bit in Table 19. CONFIG 1: Configuration Register 1, page 23, for the setting of this output signal. The default output is an active high signal. When a PME event is received, LWAKE and PME# assert at the same time if LWPME (bit4, CONFIG4) is set to 0. If LWPME is set to 1, LWAKE asserts only when PME# asserts and ISOLATEB is low. This pin is a 3.3V signaling output pin.

## 5.2. PCI Interface

**Table 2. PCI Interface**

Symbol	Type	Pin No	Description
AD31-0	T/S	33, 34, 36, 37, 39, 40, 42, 43, 47, 49, 50, 53, 55, 57, 58, 59, 79, 82, 83, 85, 86, 87, 89, 90, 93, 95, 96, 97, 98, 103, 104	PCI Address and Data Multiplexed Pins.
C/BE3-0	T/S	44, 60, 77, 92	PCI Bus Command and Byte Enables Multiplexed Pins.
CLK	I	28	Clock. This PCI Bus clock provides timing for all transactions and bus phases, and is input to PCI devices. The rising edge defines the start of each phase. The clock frequency ranges from 0 to 40MHz. For normal network operation, the RTL8100C(L) requires a minimum PCI clock frequency of 16.75MHz.
DEVSELB	S/T/S	68	Device Select. As a bus master, the RTL8100C (L) samples this signal to ensure that a PCI target recognizes the destination address for the data transfer. As a target, the RTL8100C(L) asserts this signal low when it recognizes its target address after FRAMEB is asserted.
FRAMEB	S/T/S	61	Cycle Frame. As a bus master, this pin indicates the beginning and duration of an access. FRAMEB is asserted low to indicate the start of a bus transaction. While FRAMEB is asserted, data transfer continues. When FRAMEB is deasserted, the transaction is in the final data phase. As a target, the device monitors this signal before decoding the address to check if the current transaction is addressed to it.
GNTB	I	29	Grant. This signal is asserted low to indicate to the RTL8100C(L) that the central arbiter has granted ownership of the bus to the RTL8100C(L). This input is used when the RTL8100C(L) is acting as a bus master.
REQB	T/S	30	Request. The RTL8100C(L) will assert this signal low to request the ownership of the bus from the central arbiter.
IDSEL	I	46	Initialization Device Select. This pin allows the RTL8100C(L) to identify when configuration read/write transactions are intended for it.
INTAB	O/D	25	INTAB. Used to request an interrupt. It is asserted low when an interrupt condition occurs, as defined by the Interrupt Status, Interrupt Mask and Interrupt Enable registers.

Symbol	Type	Pin No	Description
IRDYB	S/T/S	63	<p>Initiator Ready.</p> <p>This indicates the initiating agent's ability to complete the current data phase of the transaction.</p> <p>As a bus master, this signal will be asserted low when the RTL8100C(L) is ready to complete the current data phase transaction. This signal is used in conjunction with the TRDYB signal. Data transaction takes place at the rising edge of CLK when both IRDYB and TRDYB are asserted low. As a target, this signal indicates that the master has put data on the bus.</p>
TRDYB	S/T/S	67	<p>Target Ready.</p> <p>This indicates the target agent's ability to complete the current phase of the transaction.</p> <p>As a bus master, this signal indicates that the target is ready for the data during write operations and holds the data during read operations. As a target, this signal will be asserted low when the (slave) device is ready to complete the current data phase transaction. This signal is used in conjunction with the IRDYB signal. Data transaction takes place at the rising edge of CLK when both IRDYB and TRDYB are asserted low.</p>
PAR	T/S	76	<p>Parity.</p> <p>This signal indicates even parity across AD31-0 and C/BE3-0 including the PAR pin. As a master, PAR is asserted during address and write data phases. As a target, PAR is asserted during read data phases.</p>
PERRB	S/T/S	70	<p>Parity Error.</p> <p>When the RTL8100C(L) is the bus master and a parity error is detected, the RTL8100C(L) asserts both the SERR bit in ISR, and Configuration Space command bit 8 (SERRB enable). Next, it completes the current data burst transaction, then stops operation and resets itself. After the host clears the system error, the RTL8100C(L) continues its operation.</p> <p>When the RTL8100C(L) is the bus target and a parity error is detected, the RTL8100C(L) asserts this PERRB pin low.</p>
SERRB	O/D	75	<p>System Error.</p> <p>If an address parity error is detected and Configuration Space Status register bit 15 (detected parity error) is enabled, the RTL8100C(L) asserts both the SERRB pin low, and bit 14 of the Status register in Configuration Space.</p>
STOPB	S/T/S	69	<p>Stop.</p> <p>Indicates the current target is requesting the master to stop the current transaction.</p>
RSTB	I	27	<p>Reset.</p> <p>When RSTB is asserted low, the RTL8100C(L) performs an internal system hardware reset. RSTB must be held for a minimum of 120ns.</p>

### 5.3. EPROM/EEPROM Interface/AUX

**Table 3. EPROM/EEPROM Interface/AUX**

Symbol	Type	Pin No	Description
EESK	O	111	The MA2-0 pins are switched to EESK, EEDI, EEDO in 93C46 programming or auto-load mode.
EEDO	O, I	108	
AUX / EEDI	I/O	109	<p>Aux. Power Detect.</p> <p>This pin is used to notify the RTL8100C(L) of the existence of Aux. power (only during initial power-on). This pin should be pulled high to the auxiliary power (5VPM or 3VAUX) via a resistor to detect the Aux. power. Doing so will enable wakeup support from ACPI D3 cold or APM power-down. If this pin is not pulled high, the RTL8100C(L) assumes that no auxiliary power exists.</p> <p>EEDI: After Aux. Power On Detection is complete; EEDI is enabled to support EEPROM auto-load operation.</p>
EECS	O	106	EEPROM chip select.

### 5.4. Power Pins

**Table 4. Power Pins**

Symbol	Type	Pin No	Description
VDD33	P	26, 41, 56, 71, 84, 94, 107	+3.3V (Digital)
AVDD33	P	3, 7, 20	+3.3V (Analog).
VDD25	P	32, 54, 78, 99	+2.5V (Digital).
AVDD25	P	12	+2.5V (Analog).
GND	P	4, 17, 21, 35, 38, 51, 52, 66, 80, 81, 91, 100, 101, 119, 123, 124, 128	Ground.

### 5.5. LED Interface

**Table 5. LED Interface**

Symbol	Type	Pin No	Description					
LED0, 1, 2	O	117, 115, 114	LED Pins					
			<b>LEDS1-0</b>	<b>00</b>	<b>01</b>	<b>10</b>	<b>11</b>	
			LED0	TX/RX	TX/RX	TX	TX	
			LED1	LINK100	LINK10/100	LINK10/100	LINK100	
			LED2	LINK10	FULL	RX	LINK10	
During power down mode, the LEDs are OFF.								



## 5.6. Attachment Unit Interface

**Table 6. Attachment Unit Interface**

Symbol	Type	Pin No	Description
TXD+	O	1	100/10Base-T Transmit (TX) data.
TXD-	O	2	
RXIN+	I	5	100/10Base-T Receive (RX) data.
RXIN-	I	6	
X1	I	121	25MHz Crystal/OSC Input.
X2	O	122	Crystal Feedback Output. This output is used in a crystal connection only. It must be left open when X1 is driven with an external 25MHz oscillator.

## 5.7. Test and Other Pins

**Table 7. Test and Other Pins**

Symbol	Type	Pin No	Description
RTT3	TEST	123	Chip Test pin.
RTSET	I/O	127	This pin must be pulled low by a resistor. Refer to section 9 Application Information, page 61, for the correct value.
CTRL25	Analog	8	Use this pin and an external PNP type transistor to generate +2.5V for the RTL8100C(L).
CLKRUN	I/O	65	Clock Run. This signal is used to request starting (or speeding up) of the clock. CLKRUN also indicates the clock status. CLKRUN is an open drain output as well as an input. The RTL8100C(L) requests the central resource to start, speed up, or maintain the interface clock by the assertion of CLKRUN. For the host system, it is an S/T/S signal. The host system (central resource) is responsible for maintaining CLKRUN asserted, and for driving it high to the negated (deasserted) state.
NC	-	9~11,13~16, 18, 19, 22, 24, 45, 48, 62, 72~74, 110, 112, 116, 118, 120, 125, 126	Not Connected.

## 5.8. Register Descriptions

The RTL8100C(L) provides the following set of operational registers mapped into PCI memory space or I/O space.

**Table 8. Register Descriptions**

Offset	R/W	Tag	Description
0000h	R/W	IDR0	ID Register 0. ID registers 0-5 are only permitted to read/write via 4-byte access. Read access can be byte, word, or double word access. The initial value is autoloaded from the EEPROM EthernetID field.
0001h	R/W	IDR1	ID Register 1.
0002h	R/W	IDR2	ID Register 2.
0003h	R/W	IDR3	ID Register 3.
0004h	R/W	IDR4	ID Register 4.
0005h	R/W	IDR5	ID Register 5.
0006h-0007h	-	-	Reserved.
0008h	R/W	MAR0	Multicast Address Register 0. The MAR register 0-7 are only permitted to read/write via 4-byte access. Read access can be byte, word, or double word access. The driver is responsible for initializing these registers.
0009h	R/W	MAR1	Multicast Address Register 1.
000Ah	R/W	MAR2	Multicast Address Register 2.
000Bh	R/W	MAR3	Multicast Address Register 3.
000Ch	R/W	MAR4	Multicast Address Register 4.
000Dh	R/W	MAR5	Multicast Address Register 5.
000Eh	R/W	MAR6	Multicast Address Register 6.
000Fh	R/W	MAR7	Multicast Address Register 7.
0010h-0013h	R/W	TSD0	Transmit Status of Descriptor 0.
0014h-0017h	R/W	TSD1	Transmit Status of Descriptor 1.
0018h-001Bh	R/W	TSD2	Transmit Status of Descriptor 2.
001Ch-001Fh	R/W	TSD3	Transmit Status of Descriptor 3.
0020h-0023h	R/W	TSAD0	Transmit Start Address of Descriptor 0.
0024h-0027h	R/W	TSAD1	Transmit Start Address of Descriptor 1.
0028h-002Bh	R/W	TSAD2	Transmit Start Address of Descriptor 2.
002Ch-002Fh	R/W	TSAD3	Transmit Start Address of Descriptor 3.
0030h-0033h	R/W	RBSTART	Receive (Rx) Buffer Start Address.
0034h-0035h	R	ERBCR	Early Receive (Rx) Byte Count Register.
0036h	R	ERSR	Early Rx Status Register.
0037h	R/W	CR	Command Register.
0038h-0039h	R/W	CAPR	Current Address of Packet Read.
003Ah-003Bh	R	CBR	Current Buffer Address. The initial value is 0000h. It reflects total received byte-count in the Rx buffer.
003Ch-003Dh	R/W	IMR	Interrupt Mask Register.
003Eh-003Fh	R/W	ISR	Interrupt Status Register.
0040h-0043h	R/W	TCR	Transmit (Tx) Configuration Register.

Offset	R/W	Tag	Description
0044h-0047h	R/W	RCR	Receive (Rx) Configuration Register.
0048h-004Bh	R/W	TCTR	Timer Count Register. This register contains a 32-bit general-purpose timer. Writing any value to this register will reset the original timer and start a count from zero.
004Ch-004Fh	R/W	MPC	Missed Packet Counter. Indicates the number of packets discarded due to Rx FIFO overflow. It is a 24-bit counter. After s/w reset, MPC is cleared. Only the lower 3 bytes are valid. When any value is written, MPC will be reset also.
0050h	R/W	9346CR	93C46 Command Register.
0051h	R/W	CONFIG0	Configuration Register 0.
0052h	R/W	CONFIG1	Configuration Register 1.
0053h	-	-	Reserved.
0054h-0057h	R/W	TimerInt	Timer Interrupt Register. Once having written a non-zero value to this register, the Timeout bit of the ISR register will be set whenever the TCTR reaches that value. The Timeout bit will never be set whilst the TimerInt register is zero.
0058h	R/W	MSR	Media Status Register.
0059h	R/W	CONFIG3	Configuration register 3.
005Ah	R/W	CONFIG4	Configuration register 4.
005Bh	-	-	Reserved.
005Ch-005Dh	R/W	MULINT	Multiple Interrupt Select.
005Eh	R	RERID	PCI Revision ID = 10h.
005Fh	-	-	Reserved.
0060h-0061h	R	TSAD	Transmit Status of All Descriptors.
0062h-0063h	R/W	BMCR	Basic Mode Control Register.
0064h-0065h	R	BMSR	Basic Mode Status Register.
0066h-0067h	R/W	ANAR	Auto-Negotiation Advertisement Register.
0068h-0069h	R	ANLPAR	Auto-Negotiation Link Partner Register.
006Ah-006Bh	R	ANER	Auto-Negotiation Expansion Register.
006Ch-006Dh	R	DIS	Disconnect Counter.
006Eh-006Fh	R	FCSC	False Carrier Sense Counter.
0070h-0071h	R/W	NWAYTR	N-way Test Register.
0072h-0073h	R	REC	RX_ER Counter.
0074h-0075h	R/W	CSCR	CS Configuration Register.
0076-0077h	-	-	Reserved.
0078h-007Bh	R/W	PHY1_PARM	PHY Parameter 1.
007Ch-007Fh	R/W	TW_PARM	Twister Parameter.
0080h	R/W	PHY2_PARM	PHY Parameter 2.
0081-0083h	-	-	Reserved.
0084h	R/W	CRC0	Power Management CRC register 0 for wakeup frame 0.
0085h	R/W	CRC1	Power Management CRC register 1 for wakeup frame 1.
0086h	R/W	CRC2	Power Management CRC register 2 for wakeup frame 2.
0087h	R/W	CRC3	Power Management CRC register 3 for wakeup frame 3.
0088h	R/W	CRC4	Power Management CRC register 4 for wakeup frame 4.

Offset	R/W	Tag	Description
0089h	R/W	CRC5	Power Management CRC register 5 for wakeup frame 5.
008Ah	R/W	CRC6	Power Management CRC register 6 for wakeup frame 6.
008Bh	R/W	CRC7	Power Management CRC register 7 for wakeup frame 7.
008Ch–0093h	R/W	Wakeup0	Power Management Wakeup frame 0 (64-bit).
0094h–009Bh	R/W	Wakeup1	Power Management Wakeup frame 1 (64-bit).
009Ch–00A3h	R/W	Wakeup2	Power Management Wakeup frame 2 (64-bit).
00A4h–00ABh	R/W	Wakeup3	Power Management Wakeup frame 3 (64-bit).
00ACh–00B3h	R/W	Wakeup4	Power Management Wakeup frame 4 (64-bit).
00B4h–00BBh	R/W	Wakeup5	Power Management Wakeup frame 5 (64-bit).
00BCh–00C3h	R/W	Wakeup6	Power Management Wakeup frame 6 (64-bit).
00C4h–00CBh	R/W	Wakeup7	Power Management Wakeup frame 7 (64-bit).
00CCh	R/W	LSBCRC0	LSB of the mask byte of wakeup frame 0 within offset 12 to 75.
00CDh	R/W	LSBCRC1	LSB of the mask byte of wakeup frame 1 within offset 12 to 75.
00CEh	R/W	LSBCRC2	LSB of the mask byte of wakeup frame 2 within offset 12 to 75.
00CFh	R/W	LSBCRC3	LSB of the mask byte of wakeup frame 3 within offset 12 to 75.
00D0h	R/W	LSBCRC4	LSB of the mask byte of wakeup frame 4 within offset 12 to 75.
00D1h	R/W	LSBCRC5	LSB of the mask byte of wakeup frame 5 within offset 12 to 75.
00D2h	R/W	LSBCRC6	LSB of the mask byte of wakeup frame 6 within offset 12 to 75.
00D3h	R/W	LSBCRC7	LSB of the mask byte of wakeup frame 7 within offset 12 to 75.
00D4h–00D7h	-	-	Reserved.
00D8h	R/W	Config5	Configuration register 5.
00D9h–00FFh	-	-	Reserved.

## 5.9. Receive Status Register in RX Packet Header

**Table 9. Receive Status Register in RX Packet Header**

Bit	R/W	Symbol	Description
15	R	MAR	Multicast Address Received. This bit set to 1 indicates that a multicast packet has been received.
14	R	PAM	Physical Address Matched. This bit set to 1 indicates that the destination address of this packet matches the value written in ID registers.
13	R	BAR	Broadcast Address Received. This bit set to 1 indicates that a broadcast packet is received. BAR, MAR bit will not be set simultaneously.
12-6	-	-	Reserved.
5	R	ISE	Invalid Symbol Error (100Base-TX only). This bit set to 1 indicates that an invalid symbol was encountered during the reception of this packet.
4	R	RUNT	Runt Packet Received. This bit set to 1 indicates that the received packet length is smaller than 64 bytes ( i.e. media header + data + CRC < 64 bytes )
3	R	LONG	Long Packet. This bit set to 1 indicates that the size of the received packet exceeds 4k bytes.

Bit	R/W	Symbol	Description
2	R	CRC	Cyclic Redundancy Check (CRC) Error. When set, indicates that a CRC error occurred on the received packet.
1	R	FAE	Frame Alignment Error. When set, indicates that a frame alignment error occurred on this received packet.
0	R	ROK	Receive OK. When set, indicates that a good packet was received.

### 5.10. Transmit Status Register (TSD0-3)(Offset 0010h-001Fh, R/W)

The read-only bits (CRS, TABT, OWC, CDH, NCC3-0, TOK, TUN) will be cleared by the RTL8100C(L) when the Transmit Byte Count (bits 12-0) in the corresponding Tx descriptor is written. It is not affected when software writes to these bits. These registers are only permitted to be written via double-word access. After a software reset, all bits except OWN bit are reset to 0.

**Table 10. Transmit Status Register**

Bit	R/W	Symbol	Description
31	R	CRS	Carrier Sense Lost. This bit is set to 1 when the carrier is lost during transmission of a packet.
30	R	TABT	Transmit Abort. This bit is set to 1 if the transmission of a packet was aborted. This bit is read only, writing to this bit is not affected.
29	R	OWC	Out of Window Collision. This bit is set to 1 if the RTL8100C(L) encountered an 'out of window' collision during the transmission of a packet.
28	R	CDH	CD HeartBeat. The NIC watches for a collision signal (i.e., CD Heartbeat signal) during the first 6.4 $\mu$ s of the InterFrame Gap following a transmission. This bit is set if the transceiver fails to send this signal. This bit is cleared in 100Mbps mode.
27-24	R	NCC3-0	Number of Collision Count. Indicates the number of collisions encountered during the transmission of a packet.
23-22	-	-	Reserved.
21-16	R/W	ERTXTH5-0	Early Tx Threshold. Specifies the threshold level in the Tx FIFO to begin the transmission. When the byte count of the data in the Tx FIFO reaches this level, (or the FIFO contains at least one complete packet) the RTL8100C(L) will transmit this packet. 000000 = 8 bytes These fields count from 000001 to 111111 in units of 32 bytes. This threshold must be prevented from exceeding 2k bytes.

Bit	R/W	Symbol	Description
15	R	TOK	Transmit OK. Set to 1 indicates that the transmission of a packet was completed successfully and no transmit underrun has occurred.
14	R	TUN	Transmit FIFO Underrun. Set to 1 if the Tx FIFO was exhausted during the transmission of a packet. The RTL8100C(L) can re-transfer data if the Tx FIFO underruns. That is, when TSD<TUN>=1, TSD<TOK>=0 and ISR<TOK>=1 (or ISR<TER>=1).
13	R/W	OWN	OWN. The RTL8100C(L) sets this bit to 1 when the Tx DMA operation of this descriptor has completed. The driver must set this bit to 0 when the Transmit Byte Count (bits 0-12) is written. The default value is 1.
12-0	R/W	SIZE	Descriptor Size. The total size in bytes of the data in this descriptor. If the packet length is more than 1792 bytes (0700h), the Tx queue will be invalid, i.e. the next descriptor will be written only after the OWN bit of that long packet's descriptor has been set.

### 5.11. ERSR: Early RX Status Register (Offset 0036h, R)

Table 11. ERSR: Early RX Status Register

Bit	R/W	Symbol	Description
7-4	-	-	Reserved.
3	R	ERGood	Early Rx Good packet. This bit is set whenever a packet is completely received and the packet is good. Writing a 1 to this bit will clear it.
2	R	ERBad	Early Rx Bad packet. This bit is set whenever a packet is completely received and the packet is bad. Writing a 1 to this bit will clear it.
1	R	EROVW	Early Rx OverWrite. This bit is set when the RTL8100C(L)'s local address pointer is equal to CAPR. In Early Mode, this is different from buffer overflow. It happens when the RTL8100C(L) detects an Rx error and wants to fill another packet data from the beginning address of that error packet. Writing a 1 to this bit will clear it.
0	R	EROK	Early Rx OK. The power-on value is 0. It is set when the Rx byte count of the arriving packet exceeds the Rx threshold. After the whole packet is received, the RTL8100C(L) will set ROK or RER in ISR and clear this bit simultaneously. Setting this bit will invoke an ROK interrupt.

### 5.12. Command Register (Offset 0037h, R/W)

This register is used for issuing commands to the RTL8100C(L). These commands are issued by setting the corresponding bits for the function. A global software reset along with individual reset and enable/disable for transmitter and receiver are provided here.

**Table 12. Command Register**

Bit	R/W	Symbol	Description
7-5	-	-	Reserved.
4	R/W	RST	Reset. Setting to 1 forces the RTL8100C(L) to a software reset state which disables the transmitter and receiver, reinitializes the FIFOs, resets the system buffer pointer to the initial value (Tx buffer is at TSAD0, Rx buffer is empty). The values of IDR0-5 and MAR0-7 and PCI configuration space will have no changes. This bit is 1 during the reset operation, and is cleared to 0 by the RTL8100C(L) when the reset operation is complete.
3	R/W	RE	Receiver Enable. When set to 1, makes the idle receive state machine active. This bit will read back as a 1 whenever the receive state machine is active. After initial power-up, software must ensure that the receiver has completely reset before setting this bit. This bit will be reset after PCI reset deassertion.
2	R/W	TE	Transmitter Enable. When set to 1, and the transmit state machine is idle, then the transmit state machine becomes active. This bit will read back as a 1 whenever the transmit state machine is active. After initial power-up, software must ensure that the transmitter has completely reset before setting this bit. This bit will be reset after PCI reset deassertion.
1	-	-	Reserved.
0	R	BUFE	Buffer Empty. RX Buffer Empty. There are no packets stored in the RX buffer ring.

### 5.13. Interrupt Mask Register (Offset 003Ch-003Dh, R/W)

This register masks the interrupts that can be generated from the Interrupt Status Register. A hardware reset will clear all mask bits. Setting a mask bit allows the corresponding bit in the Interrupt Status Register to cause an interrupt. The Interrupt Status Register bits are always set to 1 if the condition is present, regardless of the state of the corresponding mask bit.

**Table 13. Interrupt Mask Register**

Bit	R/W	Symbol	Description
15	R/W	SERR	System Error Interrupt. 1: Enable 0: Disable
14	R/W	TimeOut	Time Out Interrupt. 1: Enable 0: Disable

Bit	R/W	Symbol	Description
13	R/W	LenChg	Cable Length Change Interrupt. 1: Enable 0: Disable
12-7	-	-	Reserved.
6	R/W	FOVW	Rx FIFO Overflow Interrupt. 1: Enable 0: Disable
5	R/W	PUN/LinkChg	Packet Underrun/Link Change Interrupt. 1: Enable 0: Disable
4	R/W	RXOVW	Rx Buffer Overflow Interrupt. 1: Enable 0: Disable
3	R/W	TER	Transmit Error Interrupt. 1: Enable 0: Disable
2	R/W	TOK	Transmit OK Interrupt. 1: Enable 0: Disable
1	R/W	RER	Receive Error Interrupt. 1: Enable 0: Disable
0	R/W	ROK	Receive OK Interrupt. 1: Enable 0: Disable

### ***5.14. Interrupt Status Register (Offset 003Eh-003Fh, R/W)***

This register indicates the source of an interrupt when the INTA pin goes active. Enabling the corresponding bits in the Interrupt Mask Register (IMR) allows bits in this register to produce an interrupt. When an interrupt is active, one or more bits in this register are set to 1. The interrupt Status Register reflects all current pending interrupts, regardless of the state of the corresponding mask bit in the IMR. Reading the ISR clears all interrupts. Writing to the ISR has no effect.

**Table 14. Interrupt Status Register**

Bit	R/W	Symbol	Description
15	R/W	SERR	System Error. Set to 1 when the RTL8100C(L) signals a system error on the PCI bus.
14	R/W	TimeOut	Time Out. Set to 1 when the TCTR register reaches the value of the TimerInt register.
13	R/W	LenChg	Cable Length Change. Cable length is changed after Receiver is enabled.
12 - 7	-	-	Reserved.



Bit	R/W	Symbol	Description
6	R/W	FOVW	Rx FIFO Overflow. Set when an overflow occurs on the Rx status FIFO.
5	R/W	PUN/LinkChg	Packet Underrun/Link Change. Set to 1 when CAPR is written but Rx buffer is empty, or when link status is changed.
4	R/W	RXOVW	Rx Buffer Overflow. Set when receive (Rx) buffer ring storage resources have been exhausted.
3	R/W	TER	Transmit (Tx) Error. Indicates that a packet transmission was aborted, due to excessive collisions, according to the TXRR's setting.
2	R/W	TOK	Transmit (Tx) OK. Indicates that a packet transmission has completed successfully.
1	R/W	RER	Receive (Rx) Error. Indicates that a packet has either a CRC error or Frame Alignment Error (FAE). Collided frames will not be recognized as CRC errors if the length of the frame is shorter than 16 bytes.
0	R/W	ROK	Receive (Rx) OK. In normal mode, indicates the successful completion of a packet reception. In early mode, indicates that the Rx byte count of the arriving packet exceeds the early Rx threshold.

### 5.15. Transmit Configuration Register (Offset 0040h-0043h, R/W)

This register defines the Transmit Configuration for the RTL8100C(L). It controls such functions as Loopback, programmable InterFrame Gap, Fill and Drain Thresholds, and maximum DMA burst size.

**Table 15. Transmit Configuration Register**

Bit	R/W	Symbol	Description																																																																																																
31	-	-	Reserved.																																																																																																
30~26	R	HWVERID_A	Hardware Version ID A.																																																																																																
			<table border="1"> <thead> <tr> <th></th> <th>Bit3 0</th> <th>Bit2 9</th> <th>Bit2 8</th> <th>Bit2 7</th> <th>Bit2 6</th> <th>Bit2 3</th> <th>Bit2 2</th> </tr> </thead> <tbody> <tr> <td>RTL8139</td> <td>1</td> <td>1</td> <td>0</td> <td>0</td> <td>0</td> <td>0</td> <td>0</td> </tr> <tr> <td>RTL8139A</td> <td>1</td> <td>1</td> <td>1</td> <td>0</td> <td>0</td> <td>0</td> <td>0</td> </tr> <tr> <td>RTL8139A-G</td> <td>1</td> <td>1</td> <td>1</td> <td>0</td> <td>1</td> <td>0</td> <td>0</td> </tr> <tr> <td>RTL8139B</td> <td>1</td> <td>1</td> <td>1</td> <td>1</td> <td>0</td> <td>0</td> <td>0</td> </tr> <tr> <td>RTL8130</td> <td>1</td> <td>1</td> <td>1</td> <td>1</td> <td>0</td> <td>0</td> <td>0</td> </tr> <tr> <td>RTL8139C</td> <td>1</td> <td>1</td> <td>1</td> <td>0</td> <td>1</td> <td>0</td> <td>0</td> </tr> <tr> <td>RTL8100</td> <td>1</td> <td>1</td> <td>1</td> <td>1</td> <td>0</td> <td>1</td> <td>0</td> </tr> <tr> <td>RTL8100B RTL8100C RTL8139D</td> <td>1</td> <td>1</td> <td>1</td> <td>0</td> <td>1</td> <td>0</td> <td>1</td> </tr> <tr> <td>RTL8139C+</td> <td>1</td> <td>1</td> <td>1</td> <td>0</td> <td>1</td> <td>1</td> <td>0</td> </tr> <tr> <td>RTL8101</td> <td>1</td> <td>1</td> <td>1</td> <td>0</td> <td>1</td> <td>1</td> <td>1</td> </tr> <tr> <td>Reserved</td> <td colspan="7">Other combinations.</td> </tr> </tbody> </table>		Bit3 0	Bit2 9	Bit2 8	Bit2 7	Bit2 6	Bit2 3	Bit2 2	RTL8139	1	1	0	0	0	0	0	RTL8139A	1	1	1	0	0	0	0	RTL8139A-G	1	1	1	0	1	0	0	RTL8139B	1	1	1	1	0	0	0	RTL8130	1	1	1	1	0	0	0	RTL8139C	1	1	1	0	1	0	0	RTL8100	1	1	1	1	0	1	0	RTL8100B RTL8100C RTL8139D	1	1	1	0	1	0	1	RTL8139C+	1	1	1	0	1	1	0	RTL8101	1	1	1	0	1	1	1	Reserved	Other combinations.						
	Bit3 0	Bit2 9	Bit2 8	Bit2 7	Bit2 6	Bit2 3	Bit2 2																																																																																												
RTL8139	1	1	0	0	0	0	0																																																																																												
RTL8139A	1	1	1	0	0	0	0																																																																																												
RTL8139A-G	1	1	1	0	1	0	0																																																																																												
RTL8139B	1	1	1	1	0	0	0																																																																																												
RTL8130	1	1	1	1	0	0	0																																																																																												
RTL8139C	1	1	1	0	1	0	0																																																																																												
RTL8100	1	1	1	1	0	1	0																																																																																												
RTL8100B RTL8100C RTL8139D	1	1	1	0	1	0	1																																																																																												
RTL8139C+	1	1	1	0	1	1	0																																																																																												
RTL8101	1	1	1	0	1	1	1																																																																																												
Reserved	Other combinations.																																																																																																		

Bit	R/W	Symbol	Description
25, 24	R/W	IFG1, 0	InterFrame Gap time. This field allows the user to adjust the InterFrame Gap time below the standard: 9.6μs for 10Mbps, 960ns for 100Mbps. The time can be programmed from 9.6μs to 8.4μs (10Mbps) and 960ns to 840ns (100Mbps). Note that any value other than (1, 1) will violate the IEEE 802.3 standard. The formula for the InterFrame Gap is: 10 Mbps: 8.4μs + 0.4(IFG(1:0)) μs 100 Mbps: 840ns + 40(IFG(1:0)) ns
23, 22	R	HWVERID_B	Hardware Version ID B.
21~19	-	-	Reserved.
18, 17	R/W	LBK1, LBK0	Loopback test. There will be no packets on the TX+/- lines under the Loopback test condition. The loopback function must be independent of the link state. 00: Normal operation 01: Reserved 10: Reserved 11: Loopback mode
16	R/W	CRC	Append CRC. Setting to 1 means that there is no CRC appended at the end of a packet. Setting to 0 means that there is a CRC appended at the end of a packet.
15~11	-	-	Reserved.
10~8	R/W	MXDMA2, 1, 0	Max DMA Burst Size per Tx DMA Burst. This field sets the maximum size of transmit DMA data bursts according to the following table: 000 = 16 bytes 001 = 32 bytes 010 = 64 bytes 011 = 128 bytes 100 = 256 bytes 101 = 512 bytes 110 = 1024 bytes 111 = 2048 bytes
7-4	R/W	TXRR	Tx Retry Count. These are used to specify additional transmission retries in multiple of 16 (IEEE 802.3 CSMA/CD retry count). If the TXRR is set to 0, the transmitter will re-transmit 16 times before aborting due to excessive collisions. If the TXRR is set to a value greater than 0, the transmitter will re-transmit a number of times equals to the following formula before aborting: Total retries = 16 + (TXRR * 16) The TER bit in the ISR register or transmit descriptor will be set when the transmission fails and reaches to this specified retry count.
3-1	-	-	Reserved.
0	W	CLRABT	Clear Abort. Setting this bit to 1 causes the RTL8100C(L) to retransmit the packet at the last transmitted descriptor when this transmission was aborted, Setting this bit is only permitted in the transmit abort state.

## 5.16. Receive Configuration Register

### (Offset 0044h-0047h, R/W)

This register is used to set the receive configuration for the RTL8100C(L). Receive properties such as accepting error packets, runt packets, setting the receive drain threshold etc. are controlled here.

**Table 16. Receive Configuration Register**

Bit	R/W	Symbol	Description																
31-28	-	-	Reserved.																
27-24	R/W	ERTH3, 2, 1, 0	<p>Early Rx threshold bits.</p> <p>These bits are used to select the Rx threshold multiplier of a whole packet that has been transferred to the system buffer in early mode whilst the frame protocol is under the RTL8100C(L)'s definition.</p> <table border="1"> <tr> <td>0000 = No early Rx threshold</td> <td>0001 = 1/16</td> </tr> <tr> <td>0010 = 2/16</td> <td>0011 = 3/16</td> </tr> <tr> <td>0100 = 4/16</td> <td>0101 = 5/16</td> </tr> <tr> <td>0110 = 6/16</td> <td>0111 = 7/16</td> </tr> <tr> <td>1000 = 8/16</td> <td>1001 = 9/16</td> </tr> <tr> <td>1010 = 10/16</td> <td>1011 = 11/16</td> </tr> <tr> <td>1100 = 12/16</td> <td>1101 = 13/16</td> </tr> <tr> <td>1110 = 14/16</td> <td>1111 = 15/16</td> </tr> </table>	0000 = No early Rx threshold	0001 = 1/16	0010 = 2/16	0011 = 3/16	0100 = 4/16	0101 = 5/16	0110 = 6/16	0111 = 7/16	1000 = 8/16	1001 = 9/16	1010 = 10/16	1011 = 11/16	1100 = 12/16	1101 = 13/16	1110 = 14/16	1111 = 15/16
0000 = No early Rx threshold	0001 = 1/16																		
0010 = 2/16	0011 = 3/16																		
0100 = 4/16	0101 = 5/16																		
0110 = 6/16	0111 = 7/16																		
1000 = 8/16	1001 = 9/16																		
1010 = 10/16	1011 = 11/16																		
1100 = 12/16	1101 = 13/16																		
1110 = 14/16	1111 = 15/16																		
23-18	-	-	Reserved.																
17	R/W	MulERINT	<p>Multiple Early Interrupt select.</p> <p>When this bit is set, any received packet invokes early interrupt according to MULINT&lt;MISR[11:0]&gt; setting in early mode. When this bit is reset, the packets of familiar protocols (IPX, IP, NDIS, etc) invoke early interrupt according to RCR&lt;ERTH[3:0]&gt; setting in early mode. The packets of unfamiliar protocols will invoke early interrupt according to the setting of MULINT&lt;MISR[11:0]&gt;.</p>																
16	R/W	RER8	<p>Receive Error 8 bytes.</p> <p>1: The RTL8100C(L) accepts error packets with a length of 8~64 bytes.</p> <p>0: The RTL8100C(L) accepts error packets with a length larger than 64 bytes. The power-on default is zero.</p> <p>If AER or AR is set, the RER (Receive Error) will be set when the RTL8100C(L) receives an error packet with a length larger than 8 bytes. RER8 is irrelevant in this situation.</p>																

Bit	R/W	Symbol	Description
15~13	R/W	RXFTH2, 1, 0	<p>Rx FIFO Threshold.</p> <p>Specifies the Rx FIFO Threshold level. When the number of received data bytes from a packet that is being received into the RTL8100C(L)'s Rx FIFO has reached this level (or the FIFO contains a complete packet), the receive PCI bus master function will begin to transfer the data from the FIFO to the host memory. This field sets the threshold level according to the following table:</p> <p>000 = 16 bytes            001 = 32 bytes            010 = 64 bytes            011 = 128 bytes            100 = 256 bytes            101 = 512 bytes            110 = 1024 bytes            111 = No Rx threshold. The RTL8100C(L) begins the transfer of data after receiving a whole packet in the FIFO.</p>
12, 11	R/W	RBLLEN1, 0	<p>Rx Buffer Length.</p> <p>This field indicates the size of the Rx ring buffer:</p> <p>00 = 8k + 16 bytes            01 = 16k + 16 bytes            10 = 32K + 16 bytes            11 = 64K + 16 bytes</p>
10~8	R/W	MXDMA2, 1, 0	<p>Max DMA Burst Size per Rx DMA Burst.</p> <p>This field sets the maximum size of the receive DMA data bursts:</p> <p>000 = 16 bytes            001 = 32 bytes            010 = 64 bytes            011 = 128 bytes            100 = 256 bytes            101 = 512 bytes            110 = 1024 bytes            111 = Unlimited</p>
7	R/W	WRAP	<p>Wraps packet data into the beginning of the Rx buffer.</p> <p>0: The RTL8100C(L) will transfer the rest of the packet data into the beginning of the Rx buffer if this packet has not been completely moved into the Rx buffer and the transfer has arrived at the end of the Rx buffer.</p> <p>1: The RTL8100C(L) will keep moving the rest of the packet data into the memory immediately after the end of the Rx buffer, if this packet has not been completely moved into the Rx buffer and the transfer has arrived at the end of the Rx buffer. The software driver must reserve at least 1.5 Kbytes buffer to accept the remainder of the packet. We assume that the remainder of the packet is X bytes. The next packet will be moved into the memory from the X byte offset at the top of the Rx buffer.</p> <p>This bit is invalid when the Rx buffer is set to 64 Kbytes.</p>
6	-	-	Reserved.

Bit	R/W	Symbol	Description
5	R/W	AER	Accept Error Packet. 1: Packets with CRC errors, alignment errors, and/or collided fragments will be accepted. 0: Packets with the above errors will be rejected.
4	R/W	AR	Accept Runt. This bit allows the receiver to accept packets that are smaller than 64 bytes. The packet must be at least 8 bytes long to be accepted as a runt. 1: Accept 0: Reject
3	R/W	AB	Accept Broadcast packets. 1: Accept 0: Reject
2	R/W	AM	Accept Multicast packets. 1: Accept 0: Reject
1	R/W	APM	Accept Physical Match packets. 1: Accept 0: Reject
0	R/W	AAP	Accept All Packets. Set to 1 to accept all packets with a physical destination address. 1: Accept 0: Reject

## 5.17. 9346CR: 93C46 Command Register (Offset 0050h, R/W)

This register is used for issuing commands to the RTL8100C(L). These commands are issued by setting the corresponding bits for the function. A warm software reset along with individual reset and enable/disable for transmitter and receiver are also provided.

**Table 17. 9346CR: 93C46 Command Register**

Bit	R/W	Symbol	Description		
7-6	R/W	EEM1-0	Operating Mode: These 2 bits set the RTL8100C(L) operating mode.		
			<b>EEM1</b>	<b>EEM0</b>	<b>Operating Mode</b>
			0	0	Normal: RTL8100C(L) network/host communication mode.
			0	1	Auto-load: Entering this mode will force the RTL8100C(L) to load the contents of the 93C46 as if an RSTB signal had been asserted. This auto-load operation will take about 2ms. After it is completed, the RTL8100C(L) goes back to normal mode automatically (EEM1 = 0 EEM0 = 0) and all other registers are reset to default values.
			1	0	93C46 Programming: In this mode, both network and host bus master operations are disabled. The 93C46 can be directly accessed via bit3-0 which now reflects the states of EECS, EESK, EEDI, & EEDO pins respectively.
			1	1	Config Register Write Enable: Before writing to CONFIG0, 1, 3, 4 registers, and bit 13, 12, and 8 of BMCR (offset 62h-63h), the RTL8100C(L) must be placed in this mode. This will protect the RTL8100C(L)'s configuration from accidental change.
4-5	-	-	Reserved.		
3	R/W	EECS	These bits reflect the state of EECS, EESK, EEDI, and EEDO pins in auto-load or 93C46 programming mode.		
2	R/W	EESK			
1	R/W	EEDI			
0	R	EEDO			

### 5.18. CONFIG 0: Configuration Register 0 (Offset 0051h, R/W)

**Table 18. CONFIG 0: Configuration Register 0**

Bit	R/W	Symbol	Description
7	R	SCR	Scrambler Mode. Always 0.
6	R	PCS	PCS Mode. Always 0.
5	R	T10	10Mbps Mode. Always 0.
4-3	R	PL1, PL0	10Mbps Medium Type. Always (PL1, PL0) = (1, 0).
2-0	-	-	Reserved.

### 5.19. CONFIG 1: Configuration Register 1 (Offset 0052h, R/W)

**Table 19. CONFIG 1: Configuration Register 1**

Bit	R/W	Symbol	Description													
7-6	R/W	LEDS1-0	Refer to section 5.5 LED Interface, page 8, for a detailed LED pin description. The initial value of these bits comes from the 93C46.													
5	R/W	DVRLOAD	Driver Load. Software may use this bit to make sure that the driver has been loaded. 1: Driver loaded 0: Driver not loaded When the command register bits IOEN, MEMEN, and BMEN of the PCI configuration space are written, the RTL8100C(L) will clear this bit automatically.													
4	R/W	LWACT	LWAKE active mode: The LWACT bit and LWPTN bit in CONFIG4 register are used to program the LWAKE pin's output signal. Depending on the combination of these two bits, there may be 4 choices of LWAKE signal, i.e., active high, active low, positive (high) pulse, and negative (low) pulse. The output pulse width is about 150ms. The default value of each of these two bits is 0, i.e., the default output signal of the LWAKE pin is an active high signal. <table border="1" style="margin-left: auto; margin-right: auto;"> <thead> <tr> <th colspan="2" rowspan="2">LWAKE Output</th> <th colspan="2">LWACT</th> </tr> <tr> <th>0</th> <th>1</th> </tr> </thead> <tbody> <tr> <th rowspan="2">LWPTN</th> <td>0</td> <td>Active high*</td> <td>Active low</td> </tr> <tr> <td>1</td> <td>Positive pulse</td> <td>Negative pulse</td> </tr> </tbody> </table>	LWAKE Output		LWACT		0	1	LWPTN	0	Active high*	Active low	1	Positive pulse	Negative pulse
LWAKE Output		LWACT														
		0	1													
LWPTN	0	Active high*	Active low													
	1	Positive pulse	Negative pulse													
* Default value.																
3	R	MEMMAP	Memory Mapping. Operational registers are mapped into PCI memory space.													
2	R	IOMAP	I/O Mapping. Operational registers are mapped into PCI I/O space.													

Bit	R/W	Symbol	Description
1	R/W	VPD	Set to enable Vital Product Data. VPD data is stored in the 93C46 from within offset 40h-7Fh.
0	R/W	PMEn	Power Management Enable. Writable only when the 93C46CR register EEM1:0 = [1:1]. Let A denote the New_Cap bit (bit 4 of the Status Register) in the PCI Configuration space offset 06H. Let B denote the Cap_Ptr register in the PCI Configuration space offset 34H. Let C denote the Cap_ID (power management) register in the PCI Configuration space offset 50H. Let D denote the power management registers in the PCI Configuration space offset from 52H to 57H. Let E denote the Next_Ptr (power management) register in the PCI Configuration space offset 51H.  <b>PMEn Description</b> 1: A=1, B=50h, C=01h, D valid, E=0 0: A=B=C=E=0, D not valid

## 5.20. Media Status Register (Offset 0058h, R/W)

This register allows configuration of device and PHY options, and provides PHY status information.

**Table 20. Media Status Register**

Bit	R/W	Symbol	Description																		
7	R/W	TXFCE/ LdTXFCE	Tx Flow Control Enable. Flow control is valid in full-duplex mode only. This register's default value comes from the 93C46.																		
			<table border="1"> <thead> <tr> <th>RTL8100C(L)</th> <th>Remote</th> <th>TXFCE/LdTXFCE</th> </tr> </thead> <tbody> <tr> <td>ANE = 1</td> <td>NWAY FLY mode</td> <td>R/O</td> </tr> <tr> <td>ANE = 1</td> <td>NWAY mode only</td> <td>R/W</td> </tr> <tr> <td>ANE = 1</td> <td>No NWAY</td> <td>R/W</td> </tr> <tr> <td>ANE = 0 &amp; full-duplex mode</td> <td>-</td> <td>R/W</td> </tr> <tr> <td>ANE = 0 &amp; half-duplex mode</td> <td>-</td> <td>Invalid</td> </tr> </tbody> </table>	RTL8100C(L)	Remote	TXFCE/LdTXFCE	ANE = 1	NWAY FLY mode	R/O	ANE = 1	NWAY mode only	R/W	ANE = 1	No NWAY	R/W	ANE = 0 & full-duplex mode	-	R/W	ANE = 0 & half-duplex mode	-	Invalid
RTL8100C(L)	Remote	TXFCE/LdTXFCE																			
ANE = 1	NWAY FLY mode	R/O																			
ANE = 1	NWAY mode only	R/W																			
ANE = 1	No NWAY	R/W																			
ANE = 0 & full-duplex mode	-	R/W																			
ANE = 0 & half-duplex mode	-	Invalid																			
			NWAY FLY mode: NWAY with flow control capability. NWAY mode only: NWAY without flow control capability.																		
6	R/W	RXFCE	RX Flow control Enable. Flow control is enabled in full-duplex mode only. The default value comes from the 93C46.																		
5	-	-	Reserved.																		
4	R	Aux_Status	Aux. Power present Status. 1: Aux. Power is present 0: Aux. Power is absent The value of this bit is fixed after each PCI reset.																		



Bit	R/W	Symbol	Description
3	R	SPEED_10	Speed. Set when current media is 10Mbps. Reset, when current media is 100Mbps.
2	R	LINKB	Inverse of Link status. 0: Link OK 1: Link Fail.
1	R	TXPF	Transmit Pause Flag. Set when the RTL8100C(L) sends a pause packet. Reset when the RTL8100C(L) sends a timer done packet.
0	R	RXPF	Receive Pause Flag. Set when the RTL8100C(L) is in backoff state because a pause packet was received. Reset when the pause state is cleared.

### ***5.21. CONFIG 3: Configuration Register3*** ***(Offset 0059h, R/W)***

**Table 21. CONFIG 3: Configuration Register3**

Bit	R/W	Symbol	Description
7	R	GNTSel	Grant Select. Sets the Frame's asserted time after the Grant signal has been asserted. Frame and Grant are PCI signals. 1: Delay one clock from GNT assertion 0: No delay
6	R/W	PARAM_En	Parameter Enable (Used in 100Mbps mode only). 0: The 9346CR register EEM1:0 = [1:1] will enable the PHY1_PARM, PHY2_PARM, and TW_PARM registers to be written via software. 1: Allows parameters to be auto-loaded from the 93C46, and disables writing to PHY1_PARM, PHY2_PARM and TW_PARM registers via software. PHY1_PARM and PHY2_PARM can be auto-loaded from the EEPROM in this mode. The parameter auto-load process is executed each time the Link is OK in 100Mbps mode.

Bit	R/W	Symbol	Description
5	R/W	Magic	<p>Magic Packet.</p> <p>This bit is valid when the PWEn bit of the CONFIG1 register is set. The RTL8100C(L) will assert the PMEB signal to wakeup the operating system when a Magic Packet is received.</p> <p>Once the RTL8100C(L) has been enabled for Magic Packet wakeup, it scans all incoming packets addressed to the node for a specific data sequence that indicates to the controller that this is a Magic Packet. A Magic Packet must also meet the basic requirements of: Destination address + Source address + data + CRC.</p> <p>The destination address may be the node ID of the receiving station or a multicast address, which includes the broadcast address.</p> <p>The specific sequence consists of 16 duplications of a 6-byte ID register, with no breaks nor interrupts. This sequence can be located anywhere within the packet, but must be preceded by a synchronization stream, 6 bytes of FFh. The device will also accept a multicast address, as long as the 16 duplications of the IEEE MAC address match the address of the ID register.</p> <p>If the Node ID is 11h 22h 33h 44h 55h 66h, then the magic packet's format is similar to the following: Destination address + source address + MISC + FF FF FF FF FF FF + MISC + 11 22 33 44 55 66 + 11 22 33 44 55 66 + 11 22 33 44 55 66 + 11 22 33 44 55 66 + 11 22 33 44 55 66 + 11 22 33 44 55 66 + 11 22 33 44 55 66 + 11 22 33 44 55 66 + 11 22 33 44 55 66 + 11 22 33 44 55 66 + 11 22 33 44 55 66 + 11 22 33 44 55 66 + 11 22 33 44 55 66 + 11 22 33 44 55 66 + MISC + CRC</p>
4	R/W	LinkUp	<p>Link Up.</p> <p>This bit is valid when the PWEn bit of CONFIG1 register is set. The RTL8100C(L), when in an adequate power state, will assert the PMEB signal to wakeup the operating system when the cable connection is re-established.</p>
3-1	-	-	Reserved.
0	R	FBtBEn	<p>Fast-Back-to-Back Enable.</p> <p>Set to 1 to enable Fast-Back-to-Back.</p>

## 5.22. CONFIG 4: Configuration Register4 (Offset 005Ah, R/W)

**Table 22. CONFIG 4: Configuration Register4**

Bit	R/W	Symbol	Description
7	R/W	RxFIFOAutoClr	Receive FIFO buffer Auto Clear. When set to 1, the RTL8100C(L) will clear the Rx FIFO buffer automatically.
6	R/W	AnaOff	Analog Power Off. This bit cannot be auto-loaded from EEPROM (93C46). 1: Turns off the analog power of the RTL8100C(L) internally 0: Normal working state. This is also the power-on default value
5	R/W	LongWF	Long Wake-up Frame. The initial value comes from EEPROM auto load. 0: The RTL8100C(L) supports up to 8 wake-up frames, each with masked bytes selected from offset 12 to 75  1: The RTL8100C(L) supports up to 5 wake-up frames, each with a 16-bit CRC algorithm for MS Wakeup Frame support. The low byte of the 16-bit CRC should be placed in the corresponding CRC register, and the high byte of the 16-bit CRC should be placed in the corresponding LSB CRC register. Wake-up frames 0 and 1 are the same as above, except that the masked bytes start from offset 0 to 63. Wake-up frames 2 and 3 are merged into one long wake-up frame with masked bytes selected from offset 0 to 127. Wake-up frames 4, 5, 6, and 7 are merged into another 2 long wake-up frames. Refer to 6.5 PCI Power Management Functions, page 45, for a detailed description.
4	R/W	LWPME	LWAKE vs. PMEB. 1: LWAKE can only be asserted when PMEB is asserted and ISOLATEB is low 0: LWAKE and PMEB are asserted at the same time
3	-	-	Reserved.
2	R/W	LWPTN	LWAKE Pattern. See the LWACT bit in Table 19. CONFIG 1: Configuration Register 1, page 23.
1	-	-	Reserved.
0	R/W	PBWakeup	Pre-Boot Wakeup. The initial value comes from EEPROM auto load. 1: Pre-Boot Wakeup disabled (suitable for CardBus and MiniPCI applications) 0: Pre-Boot Wakeup enabled

### 5.23. Multiple Interrupt Select Register (Offset 005Ch-005Dh, R/W)

Note: The following is true when  $MulERINT=0$  (bit17, RCR). When  $MulERINT=1$ , any received packet invokes an early interrupt according to the  $MISR[11:0]$  setting in Early Mode.

If the received packet data is not a familiar protocol (IPX, IP, NDIS, etc.) to the RTL8100C(L),  $RCR<ERTH[3:0]>$  will not be used to transfer data in early mode. This register will be written to the received data length in order to make an early Rx interrupt for the unfamiliar protocol.

**Table 23. Multiple Interrupt Select Register**

Bit	R/W	Symbol	Description
15-12	-	-	Reserved.
11-0	R/W	MISR11-0	Multiple Interrupt Select Register. Indicates that the RTL8100C(L) made an Rx interrupt after transferring byte data into the system memory. If the value of these bits is zero, there will be no early interrupt when the RTL8100C(L) prepares to execute the first PCI transaction of the received data. Bit1, 0 must be zero. The $ERTH3-0$ bits should not be set to 0 when the multiple interrupt select register is used.

### 5.24. PCI Revision ID (Offset 005Eh, R)

**Table 24. PCI Revision ID**

Bit	R/W	Symbol	Description
7-0	R	Revision ID	The value in PCI Configuration Space offset 08h is 10h.

### 5.25. Transmit Status of All Descriptors (TSAD) Register (Offset 0060h-0061h, R/W)

**Table 25. Transmit Status of All Descriptors (TSAD) Register**

Bit	R/W	Symbol	Description
15	R	TOK3	TOK bit of Descriptor 3.
14	R	TOK2	TOK bit of Descriptor 2.
13	R	TOK1	TOK bit of Descriptor 1.
12	R	TOK0	TOK bit of Descriptor 0.
11	R	TUN3	TUN bit of Descriptor 3.
10	R	TUN2	TUN bit of Descriptor 2.
9	R	TUN1	TUN bit of Descriptor 1.
8	R	TUN0	TUN bit of Descriptor 0.
7	R	TABT3	TABT bit of Descriptor 3.
6	R	TABT2	TABT bit of Descriptor 2.
5	R	TABT1	TABT bit of Descriptor 1.
4	R	TABT0	TABT bit of Descriptor 0.

Bit	R/W	Symbol	Description
3	R	OWN3	OWN bit of Descriptor 3.
2	R	OWN2	OWN bit of Descriptor 2.
1	R	OWN1	OWN bit of Descriptor 1.
0	R	OWN0	OWN bit of Descriptor 0.

## 5.26. Basic Mode Control Register (Offset 0062h-0063h, R/W)

**Table 26. Basic Mode Control Register**

Bit	Name	Description/Usage	Default/Attribute
15	Reset	This bit sets the status and control registers of the PHY (register 0062-0074H) to the default state. This bit is self-clearing. 1: Software reset 0: Normal operation	0, RW
14	-	Reserved.	-
13	Spd_Set	This bit sets the network speed. 1: 100Mbps 0: 10Mbps. This bit's initial value comes from the 93C46	0, RW
12	Auto Negotiation Enable (ANE)	This bit enables/disables the NWay auto-negotiation function. 1: Enable auto-negotiation, bit13 will be ignored. 0: Disables auto-negotiation, bit13 and bit8 will determine the link speed and the data transfer mode, respectively. This bit's initial value comes from the 93C46.	0, RW
11-10	-	Reserved.	-
9	Restart Auto Negotiation	This bit allows the NWay auto-negotiation function to be reset. 1: Re-start auto-negotiation 0: Normal operation	0, RW
8	Duplex Mode	This bit sets the duplex mode. 1: Full-duplex 0: Normal operation. This bit's initial value comes from the 93C46.	0, RW
7-0	-	Reserved.	-

## 5.27. Basic Mode Status Register (Offset 0064h-0065h, R)

**Table 27. Basic Mode Status Register**

Bit	Name	Description/Usage	Default/Attribute
15	100Base-T4	1: Enable 100Base-T4 support 0: Disable 100Base-T4 support	0, RO
14	100Base_TX_FD	1: Enable 100Base-TX full-duplex support 0: Disable 100Base-TX full-duplex support	1, RO
13	100BASE_TX_HD	1: Enable 100Base-TX half-duplex support 0: Disable 100Base-TX half-duplex support	1, RO
12	10Base_T_FD	1: Enable 10Base-T full-duplex support 0: Disable 10Base-T full-duplex support	1, RO
11	10_Base_T_HD	1: Enable 10Base-T half-duplex support 0: Disable 10Base-T half-duplex support	1, RO

Bit	Name	Description/Usage	Default/Attribute
10-6	-	Reserved.	-
5	Auto Negotiation Complete	1: Auto-negotiation process completed 0: Auto-negotiation process not completed	0, RO
4	Remote Fault	1: Remote fault condition detected (cleared on read) 0: No remote fault condition detected.	0, RO
3	Auto Negotiation	1: Link has not experienced fail state 0: Link experienced fail state	1, RD
2	Link Status	1: Valid link established 0: No valid link established	0, RO
1	Jabber Detect	1: Jabber condition detected 0: No jabber condition detected	0, RO
0	Extended Capability	1: Extended register capability 0: Basic register capability only	1, RO

## 5.28. Auto-Negotiation Advertisement Register (Offset 0066h-0067h, R/W)

This register contains the advertised abilities of this device, as are transmitted to its link partner during auto-negotiation.

**Table 28. Auto-Negotiation Advertisement Register**

Bit	Name	Description/Usage	Default/Attribute
15	NP	Next Page bit. 1: Transmitting the protocol specific data page 0: Transmitting the primary capabilities data page	0, RO
14	ACK	1: Acknowledge reception of link partner capability data word	0, RO
13	RF	Remote Fault. 1: Advertise remote fault detection capability 0: Do not advertise remote fault detection capability	0, RW
12-11	-	Reserved.	-
10	Pause	1: Flow control supported by local node 0: Flow control not supported by local mode	The default value comes from EEPROM, RO
9	T4	1: 100Base-T4 supported by local node 0: 100Base-T4 not supported by local node	0, RO
8	TXFD	1: 100Base-TX full-duplex supported by local node 0: 100Base-TX full-duplex not supported by local node	1, RW
7	TX	1: 100Base-TX supported by local node 0: 100Base-TX not supported by local node	1, RW
6	10FD	1: 10Base-T full-duplex supported by local node 0: 10Base-T full-duplex not supported by local node	1, RW
5	10	1: 10Base-T supported by local node 0: 10Base-T not supported by local node	1, RW
4-0	Selector	Binary encoded selector supported by this node. Currently only CSMA/CD <00001> is specified. No other protocols are supported.	<00001>, RW

## 5.29. Auto-Negotiation Link Partner Ability Register (Offset 0068h-0069h, R)

This register contains the advertised abilities of the Link Partner as received during Auto-negotiation. If Next Pages are supported, the content changes after a successful auto-negotiation.

**Table 29. Auto-Negotiation Link Partner Ability Register**

Bit	Name	Description/Usage	Default/Attribute
15	NP	Next Page bit. 1: Transmitting the protocol specific data page 0: Transmitting the primary capability data page	0, RO
14	ACK	1: Link partner acknowledges reception of local node's capability data word	0, RO
13	RF	1: Link partner is indicating a remote fault	0, RO
12-11	-	Reserved.	-
10	Pause	1: Flow control supported by link partner 0: Flow control is not supported by link partner	0, RO
9	T4	1: 100Base-T4 supported by link partner 0: 100Base-T4 not supported by link partner	0, RO
8	TXFD	1: 100Base-TX full duplex is supported by link partner 0: 100Base-TX full duplex not supported by link partner	0, RO
7	TX	1: 100Base-TX supported by link partner 0: 100Base-TX not supported by link partner	0, RO
6	10FD	1: 10Base-T full duplex supported by link partner 0: 10Base-T full duplex not supported by link partner	0, RO
5	10	1: 10Base-T is supported by link partner 0: 10Base-T not supported by link partner	0, RO
4-0	Selector	Link Partner's binary encoded node selector. Currently only CSMA/CD <00001> is specified.	<00000>, RO

### 5.30. Auto-Negotiation Expansion Register (Offset 006Ah-006Bh, R)

This register contains additional NWay auto-negotiation status information.

**Table 30. Auto-Negotiation Expansion Register**

Bit	Name	Description/Usage	Default/Attribute
15-5	-	Reserved. These bits are always set to 0.	-
4	MLF	Multiple Link Fault. 1: Fault occurred 0: No fault occurred	0, RO
3	LP_NP_ABLE	Status indicating whether the link partner supports Next Page negotiation. 1: Supported 0: Not supported	0, RO
2	NP_ABLE	This bit indicates whether the local node is able to send additional Next Pages.	0, RO
1	PAGE_RX	This bit is set when a new Link Code Word Page has been received. The bit is automatically cleared when the auto negotiation link partner's ability register (register 5) is read.	0, RO
0	LP_NW_ABLE	1: Link partner supports NWay auto negotiation.	0, RO

### 5.31. Disconnect Counter

(Offset 006Ch-006Dh, R)

**Table 31. Disconnect Counter**

Bit	Name	Description/Usage	Default/Attribute
15-0	DCNT	This 16-bit counter increments by 1 for every disconnect event. It rolls over when full. It is cleared to zero by a read command.	h'[0000], R

### 5.32. False Carrier Sense Counter (Offset 006Eh-006Fh, R)

This counter provides information required to implement the 'FalseCarriers' attribute within the MAU managed object class, Clause 30 of the IEEE 802.3u specification.

**Table 32. False Carrier Sense Counter**

Bit	Name	Description/Usage	Default/Attribute
15-0	FCSCNT	This 16-bit counter increments by 1 for each false carrier event. It is cleared to zero by a read command.	h'[0000], R



### 5.33. NWay Test Register (Offset 0070h-0071h, R/W)

**Table 33. NWay Test Register**

Bit	Name	Description/Usage	Default/Attribute
15-8	-	Reserved.	-
7	NWLPBK	1: Set NWay to loopback mode	0, RW
6-4	-	Reserved.	-
3	ENNWLE	1: LED0 Pin indicates linkpulse	0, RW
2	FLAGABD	1: Auto negotiation experienced ability detect state	0, RO
1	FLAGPDF	1: Auto negotiation experienced parallel detection fault state	0, RO
0	FLAGLSC	1: Auto negotiation experienced link status check state	0, RO

### 5.34. RX\_ER Counter (Offset 0072h-0073h, R)

**Table 34. RX\_ER Counter**

Bit	Name	Description/Usage	Default/Attribute
15-0	RXERCNT	This 16-bit counter increments by 1 for each valid packet received. It is cleared to zero by a read command.	h'[0000], R

### 5.35. CS Configuration Register (Offset 0074h-0075h, R/W)

**Table 35. CS Configuration Register**

Bit	Name	Description/Usage	Default/Attribute
15	Testfun	1: Auto negotiation to speed up internal timer	0, WO
14-10	-	Reserved.	-
9	LD	Active low TPI link disable signal. When low, TPI still transmits link pulses and TPI maintains a good link state.	1, RW
8	HEARTBEAT	The HEARTBEAT function is only valid in 10Mbps mode. 1: HEARTBEAT enable 0: HEARTBEAT disable	1, RW
7	JBEN	1: Enable jabber function 0: Disable jabber function	1, RW
6	F_LINK_100	Used to login a forced good link at 100Mbps for diagnostic purposes. 1: Disable 0: Enable	1, RW
5	F_Connect	Assertion of this bit forces the disconnect function to be bypassed.	0, RW
4	-	Reserved.	-
3	Con_status	This bit indicates the status of the connection. 1: Valid connected link detected 0: Disconnected link detected	0, RO
2	Con_status_En	Assertion of this bit configures the LED1 pin to indicate connection status.	0, RW
1	-	Reserved.	-
0	PASS_SCR	Bypass Scramble.	0, RW

### 5.36. Config5: Configuration Register 5 (Offset 00D8h, R/W)

This register, unlike other Config registers, is not protected by the 93C46 Command register. There is no need to enable the Config register write prior to writing to Config5.

**Table 36. Config5. Configuration Register 5**

Bit	R/W	Symbol	Description
7	-	-	Reserved.
6	R/W	BWF	Broadcast Wakeup Frame. 1: Enable Broadcast Wakeup Frame with Destination ID field mask bytes of FF FF FF FF FF FF 0: Default value. Disable Broadcast Wakeup Frame with Destination ID field mask bytes of FF FF FF FF FF FF
5	R/W	MWF	Multicast Wakeup Frame. 1: Enable Multicast Wakeup Frame with mask bytes of only the Destination ID field, which is a multicast address 0: Default value. Disable Multicast Wakeup Frame with mask bytes of only the Destination ID field, which is a multicast address
4	R/W	UWF	Unicast Wakeup Frame. 1: Enable Unicast Wakeup Frame with mask bytes of only the Destination ID field, which is its own physical address 0: Default value. Disable Unicast Wakeup Frame with mask bytes of only the Destination ID field, which is its own physical address
3	R/W	FIFOAddrPtr	FIFO Address Pointer (Realtek internal use only). The power-on default value of this bit is 0.
2	R/W	LDPS	Link Down Power Saving mode. 1: Disable 0: Enable. When the cable is disconnected (Link Down), the analog part will power itself down (PHY Tx part and part of the Twister) automatically except for the PHY Rx part and the part of the twister that monitors the SD signal in case the cable is reconnected and the Link should be established again
1	R/W	LANWake	LANWake signal enable/disable. 1: Enable LANWake signal 0: Disable LANWake signal
0	R/W	PME_STS	PME_Status bit. Always sticky/can be reset by PCI RST# and software. 1: The PME_Status bit may be reset by PCI reset or by software 0: The PME_Status bit may only be reset by software

### 5.37. EEPROM (93C46) Contents

The 93C46 is a 1 Kbit EEPROM. Although it is addressed by words, its contents are listed below by bytes for convenience. The RTL8100C(L) performs a series of EEPROM read operations from the 93C46 addresses 00H to 31H.

It is suggested you obtain Realtek approval before changing the default settings of the EEPROM.

**Table 37. EEPROM (93C46) Contents**

Bytes	Contents	Description
00h	29h	These 2 bytes contain the ID code word for the RTL8100C(L). The RTL8100C(L) will load the contents of the EEPROM into the corresponding location if the ID word (8129h) is right, otherwise, the RTL8100C(L) will not proceed with the EEPROM auto load process.
01h	81h	
02h-05h	-	Reserved. The RTL8100C(L) no longer supports auto load of Vendor ID and Device ID. The default values of VID and DID are hex 10EC and 8139, respectively.
06h-07h	SVID	PCI Subsystem Vendor ID. PCI configuration space offset 2Ch-2Dh.
08h-09h	SMID	PCI Subsystem ID. PCI configuration space offset 2Eh-2Fh.
0Ah	MNGNT	PCI Minimum Grant Timer. PCI configuration space offset 3Eh.
0Bh	MXLAT	PCI Maximum Latency Timer. PCI configuration space offset 3Fh.
0Ch	MSRBMCR	Bits 7-6 map to bits 7-6 of the Media Status Register (MSR). Bits 5, 4, 0 map to bits 13, 12, 8 of the Basic Mode Control Register (BMCR). Bits 3-2 are reserved. If the network speed is set to Auto-Detect mode (i.e. NWay mode), then Bit 1=0 means the local RTL8100C(L) supports flow control (IEEE 802.3x). In this case, Bit 10=1 in the Auto-negotiation Advertisement Register (offset 66h-67h). If Bit 1=1 this means the local RTL8100C(L) does not support flow control. In this case, Bit 10=0 in Auto-negotiation Advertisement. This is because some NWay switching hubs randomly send flow control pause packets if the link partner supports NWay flow control.
0Dh	CONFIG3	RTL8100C(L) Configuration register 3. Operational register offset 59H.
0Eh-13h	Ethernet ID	After an auto load command or hardware reset, the RTL8100C(L) loads the Ethernet ID to IDR0-IDR5 of the RTL8100C(L)'s I/O registers.
14h	CONFIG0	RTL8100C(L) Configuration register 0. Operational registers offset 51h.
15h	CONFIG1	RTL8100C(L) Configuration register 1. Operational registers offset 52h.
16h-17h	PMC	Power Management Capabilities. PCI configuration space address 52h and 53h. Reserved. Do not change this field without Realtek approval.
18h	PMCSR	Power Management Control/Status. PCI configuration space address 55h. Reserved. Do not change this field without Realtek approval.

Bytes	Contents	Description
19h	CONFIG4	RTL8100C(L) Configuration register 4. Operational registers offset 5Ah. Reserved. Do not change this field without Realtek approval.
1Ah-1Dh	PHY1_PARM_U	PHY Parameter 1-U for RTL8100C(L). Operational registers of the RTL8100C(L) are from 78h to 7Bh. Reserved. Do not change this field without Realtek approval.
1Eh	PHY2_PARM_U	PHY Parameter 2-U for RTL8100C(L). Operational register of the RTL8100C(L) is 80h. Reserved. Do not change this field without Realtek approval.
1Fh	CONFIG_5	Do not change this field without Realtek approval. Bit7-3: Reserved.  Bit2: Link Down Power Saving mode. 1: Disable. 0: Enable. When the cable is disconnected (Link Down), the analog part will power itself down (PHY Tx part and Twister) automatically except for the PHY Rx part and part of the twister that monitors the SD signal in case the cable is reconnected and the Link is established again.  Bit1: LANWake signal Enable/Disable. 1: Enable LANWake signal 0: Disable LANWake signal  Bit0: PME_Status bit property. 1: The PME_Status bit can be reset by PCI reset or by software if D3cold_support_PME is 0. If D3cold_support_PME=1, the PME_Status bit is a sticky bit 0: The PME_Status bit is always a sticky bit and can only be reset by software
20h-23h	TW_PARM_U	Reserved. Do not change this field without Realtek approval. Twister Parameter U for the RTL8100C(L). Operational registers of the RTL8100C(L) are 7Ch-7Fh.
24h-27h	TW_PARM_T	Reserved. Do not change this field without Realtek approval. Twister Parameter T for the RTL8100C(L). Operational registers of the RTL8100C(L) are 7Ch-7Fh.
28h-2Bh	PHY1_PARM_T	Reserved. Do not change this field without Realtek approval. PHY Parameter 1-T for the RTL8100C(L). Operational registers of the RTL8100C(L) are from 78h to 7Bh.
2Ch	PHY2_PARM_T	Reserved. Do not change this field without Realtek approval. PHY Parameter 2-T for the RTL8100C(L). Operational register of the RTL8100C(L) is 80h.
2Dh-31h	-	Reserved.
32h-33h	Checksum	Reserved. Do not change this field without Realtek approval. Checksum of the EEPROM content.
34h-3Eh	-	Reserved. Do not change this field without Realtek approval.
3Fh	PXE_Para	Reserved. Do not change this field without Realtek approval. PXE ROM code parameter.
40h-7Fh	VPD_Data	VPD data field. Offset 40h is the start address of the VPD data.

### 5.38. RTL8100C(L) EEPROM Registers Summary

**Table 38. RTL8100C(L) EEPROM Registers Summary**

Offset	Name	Type	Bit7	Bit6	Bit5	Bit4	Bit3	Bit2	Bit1	Bit0
00h-05h	IDR0 – IDR5	R/W*								
51h	CONFIG0	R	-	-	-	-	-	BS2	BS1	BS0
		W*	-	-	-	-	-	-	-	-
52h	CONFIG1	R	LEDS1	LEDS0	DVRLOAD	LWACT	MEMMAP	IOMAP	VPD	PMEN
		W*	LEDS1	LEDS0	DVRLOAD	LWACT	-	-	VPD	PMEN
58h	MSRBMCR	R	TxFCE	RxFCE	-	-	-	-	-	-
		W*	TxFCE	RxFCE	-	-	-	-	-	-
63H		R	-	-	Spd_Set	ANE	-	-	-	FUDUP
		W*	-	-	Spd_Set	ANE	-	-	-	FUDUP
59h	CONFIG3	R	GNTDel	PARM_EN	Magic	LinkUp	-	-	-	FBtBEn
		W*	-	PARM_EN	Magic	LinkUp	-	-	-	-
5Ah	CONFIG4	R/W*	RxFIFO AutoClr	AnaOff	LongWF	LWPME	-	LWPTN	-	-
78h-7Bh	PHY1_PARM	R/W**	32-bit Read Write							
7Ch-7Fh	TW1_PARM	R/W**	32-bit Read Write							
	TW2_PARM	R/W**	32-bit Read Write							
80h	PHY2_PARM	R/W**	8-bit Read Write							
D8h	CONFIG5	R/W*	-	-	-	-	-	LDPS	LAN Wake	PME_STS

\* Registers marked 'W\*', can be written only if bits EEM1:0 = [1:1].

\*\* Registers marked 'W\*\*', can be written only if bits EEM1:0 = [1:1] and CONFIG3<PARM\_EN> = 0.

### 5.39. EEPROM Power Management Registers Summary

**Table 39. EEPROM Power Management Registers Summary**

Configuration Space Offset	Name	Type	Bit7	Bit6	Bit5	Bit4	Bit3	Bit2	Bit1	Bit0
52h	PMC	R	Aux_I_b1	Aux_I_b0	DSI	Reserved	PMECLK	Version		
53h		R	PME_D3_cold	PME_D3_hot	PME_D2	PME_D1	PME_D0	D2	D1	Aux_I_b2
55h	PMCSR	R	PME_Status	-	-	-	-	-	-	PME_En
		W	PME_Status	-	-	-	-	-	-	PME_En

## 6. PCI Configuration Space Registers

### 6.1. PCI Configuration Space Table

**Table 40. PCI Configuration Space Table**

No.	Name	Type	Bit7	Bit6	Bit5	Bit4	Bit3	Bit2	Bit1	Bit0
00h	VID	R	1	1	1	0	1	1	0	0
01h		R	0	0	0	1	0	0	0	0
02h	DID	R	0	0	1	1	1	0	0	1
03h		R	1	0	0	0	0	0	0	1
04h	Command	R	0	PERRSP	0	0	-	BMEN	MEMEN	IOEN
		W	-	PERRSP	-	-	-	BMEN	MEMEN	IOEN
05h		R	0	0	0	0	0	0	FBTBEN	SERREN
		W	-	-	-	-	-	-	-	SERREN
06h	Status	R	FBBC	0	0	NewCap	0	0	0	0
07h		R	DPERR	SSERR	RMABT	RTABT	STABT	DST1	DST0	DPD
		W	DPERR	SSERR	RMABT	RTABT	STABT	-	-	DPD
08h	Revision ID	R	0	0	0	0	0	0	0	0
09h	PIFR	R	0	0	0	0	0	0	0	0
0Ah	SCR	R	0	0	0	0	0	0	0	0
0Bh	BCR	R	0	0	0	0	0	0	1	0
0Ch	CLS	R	0	0	0	0	0	0	0	0
0Dh	LTR	R	LTR7	LTR6	LTR5	LTR4	LTR3	LTP2	LTR1	LTR0
		W	LTR7	LTR6	LTR5	LTR4	LTR3	LTP2	LTR1	LTR0
0Eh	HTR	R	0	0	0	0	0	0	0	0
0Fh	BIST	R	0	0	0	0	0	0	0	0
10h	IOAR	R	0	0	0	0	0	0	0	IOIN
		W	-	-	-	-	-	-	-	-
11h		R/W	IOAR15	IOAR14	IOAR13	IOAR12	IOAR11	IOAR10	IOAR9	IOAR8
12h		R/W	IOAR23	IOAR22	IOAR21	IOAR20	IOAR19	IOAR18	IOAR17	IOAR16
13h		R/W	IOAR31	IOAR30	IOAR29	IOAR28	IOAR27	IOAR26	IOAR25	IOAR24
14h	MEMAR	R	0	0	0	0	0	0	0	MEMIN
		W	-	-	-	-	-	-	-	-
15h		R/W	MEM15	MEM14	MEM13	MEM12	MEM11	MEM10	MEM9	MEM8
16h		R/W	MEM23	MEM22	MEM21	MEM20	MEM19	MEM18	MEM17	MEM16
17h		R/W	MEM31	MEM30	MEM29	MEM28	MEM27	MEM26	MEM25	MEM24
18h-2Bh	RESERVED									
2Ch	SVID	R	SVID7	SVID6	SVID5	SVID4	SVID3	SVID2	SVID1	SVID0
2Dh		R	SVID15	SVID14	SVID13	SVID12	SVID11	SVID10	SVID9	SVID8
2Eh	SMID	R	SMID7	SMID6	SMID5	SMID4	SMID3	SMID2	SMID1	SMID0
2Fh		R	SMID15	SMID14	SMID13	SMID12	SMID11	SMID10	SMID9	SMID8
30h-33h	Reserved	-	-	-	-	-	-	-	-	-
34h	Cap_Ptr	R	0	1	0	1	0	0	0	0
35h-3Bh	RESERVED									
3Ch	ILR	R/W	ILR7	ILR6	ILR5	ILR4	ILR3	ILR2	ILR1	ILR0
3Dh	IPR	R	0	0	0	0	0	0	0	1
3Eh	MNGNT	R	0	0	1	0	0	0	0	0

No.	Name	Type	Bit7	Bit6	Bit5	Bit4	Bit3	Bit2	Bit1	Bit0
3Fh	MXLAT	R	0	0	1	0	0	0	0	0
40h-4Fh	RESERVED									
50h	PMID	R	0	0	0	0	0	0	0	1
51h	NextPtr	R	0	0	0	0	0	0	0	0
52h	PMC	R	Aux_I b1	Aux_I b0	DSI	Reserved	PMECLK	Version		
53h		R	PME_ D3 <sub>cold</sub>	PME_ D3 <sub>hot</sub>	PME_D2	PME_D1	PME_D0	D2	D1	Aux_I_b2
54h	PMCSR	R	0	0	0	0	0	0	Power State	
		W	-	-	-	-	-	-	Power State	
55h		R	PME_ Status	-	-	-	-	-	-	PME_En
		W	PME_ Status	-	-	-	-	-	-	PME_En
56h-5Fh	RESERVED									
60h	VPDID	R	0	0	0	0	0	0	1	1
61h	NextPtr	R	0	0	0	0	0	0	0	0
62h	Flag VPD Address	R/W	VPDADD R7	VPDADDR 6	VPDADD R5	VPDADD R4	VPDADD R3	VPDADD R2	VPDADD R1	VPDADD R0
63h		R/W	Flag	VPDADDR 14	VPDADD R13	VPDADD R12	VPDADD R11	VPDADD R10	VPDADD R9	VPDADD R8
64h	VPD Data	R/W	Data7	Data6	Data5	Data4	Data3	Data2	Data1	Data0
65h		R/W	Data15	Data14	Data13	Data12	Data11	Data10	Data9	Data8
66h		R/W	Data23	Data22	Data21	Data20	Data19	Data18	Data17	Data16
67h		R/W	Data31	Data30	Data29	Data28	Data27	Data26	Data25	Data24
68h-FFh	RESERVED									

## 6.2. PCI Configuration Space Functions

The PCI configuration space is intended for configuration, initialization, and catastrophic error handling functions. The functions of the RTL8100C(L)'s configuration space are described below.

**VID:** Vendor ID. This field defaults to a value of 10ECh (Realtek Semiconductor's PCI Vendor ID).

**DID:** Device ID. This field defaults to a value of 8139h.

**Command:** The command register is a 16-bit register used to provide coarse control over a device's ability to generate and respond to PCI cycles.

**Table 41. PCI Configuration Space Functions**

Bit	Symbol	Description
15-10	-	Reserved.
9	FBTBEN	Fast Back-To-Back Enable. Config3<FBtBen>=0: Read as 0. Write operation has no effect. The RTL8100C(L) will not generate Fast Back-to-back cycles. When Config3<FbtBen>=1, this read/write bit controls whether or not a master can do fast back-to-back transactions to different devices. Initialization software will set the bit if all targets are fast back-to-back capable. 1: The master is allowed to generate fast back-to-back transaction to different agents 0: Fast back-to-back transactions are only allowed to the same agent This bit's state after RST# is 0.
8	SERREN	System Error Enable. 1: The RTL8100C(L) asserts the SERRB pin when it detects a parity error on the address phase (AD<31:0> and CBEB<3:0>)
7	ADSTEP	Address/Data Stepping. Read as 0. Write operation has no effect. The RTL8100C(L) never performs address/data stepping.
6	PERRSP	Parity Error Response. 1: The RTL8100C(L) will assert the PERRB pin on detection of a data parity error when acting as the target, and will sample the PERRB pin as the master 0: Any detected parity error is ignored and the RTL8100C(L) continues normal operation Parity checking is disabled after hardware reset (RSTB).
5	VGASNOOP	VGA palette SNOOP. Read as 0. Write operation has no effect.
4	MWIEN	Memory Write and Invalidate cycle Enable. Read as 0. Write operation has no effect.
3	SCYCEN	Special Cycle Enable. Read as 0. Write operation has no effect. The RTL8100C(L) ignores all special cycle operations.
2	BMEN	Bus Master Enable. 1: The RTL8100C(L) is capable of acting as a bus master 0: The RTL8100C(L) is prohibited from acting as a PCI bus master Normally this bit is set by the system BIOS.
1	MEMEN	Memory Space Access. 1: The RTL8100C(L) responds to memory space accesses 0: The RTL8100C(L) ignores memory space accesses
0	IOEN	I/O Space Access. 1: The RTL8100C(L) responds to IO space accesses 0: The RTL8100C(L) ignores I/O space accesses



### 6.3. PCI Configuration Space Status

**Status:** The status register is a 16-bit register used to record status information for PCI bus related events. Reads to this register behave normally. Writes are slightly different in that bits can be reset, but not set.

**Table 42. PCI Configuration Space Status**

Bit	Symbol	Description
15	DPERR	Detected Parity Error. When set indicates that the RTL8100C(L) detected a parity error, even if parity error handling is disabled in the command register PERRSP bit.
14	SSERR	Signaled System Error. When set indicates that the RTL8100C(L) asserted the system error pin, SERRB. Writing a 1 clears this bit to 0.
13	RMABT	Received Master Abort. When set indicates that the RTL8100C(L) terminated a master transaction with master abort. Writing a 1 clears this bit to 0.
12	RTABT	Received Target Abort. When set indicates that the RTL8100C(L) master transaction was terminated due to a target abort. Writing a 1 clears this bit to 0.
11	STABT	Signaled Target Abort. Set to 1 whenever the RTL8100C(L) terminates a transaction with target abort. Writing a 1 clears this bit to 0.
10-9	DST1-0	Device Select Timing. These bits encode the timing of DEVSELB. They are set to 01b (medium), indicating the RTL8100C(L) will assert DEVSELB two clocks after FRAMEB is asserted.
8	DPD	Data Parity error Detected. This bit sets when the following conditions are met: <ul style="list-style-type: none"> <li>The RTL8100C(L) asserts parity error(PERRB pin) or it senses the assertion of PERRB pin by another device.</li> <li>The RTL8100C(L) operates as a bus master for the operation that caused the error.</li> <li>The Command register PERRSP bit is set.</li> </ul> Writing a 1 clears this bit to 0.
7	FBBC	Fast Back-To-Back Capable. Config3<FbtBEn>=0, Read as 0. Write operation has no effect. Config3<FbtBEn>=1, Read as 1.
6	UDF	User Definable Features. Read as 0. Write operation has no effect. The RTL8100C(L) does not support UDF.
5	66MHz	66MHz Capable. Read as 0. Write operation has no effect. The RTL8100C(L) has no 66MHz capability.
4	NewCap	New Capability. Config3<PMEn>=0, Read as 0. Write operation has no effect. Config3<PMEn>=1, Read as 1.
0-3	-	Reserved.

**RID: Revision ID Register**

The Revision ID register is an 8-bit register that specifies the RTL8100C(L) controller revision number.

**PIFR: Programming Interface Register**

The programming interface register is an 8-bit register that identifies the programming interface of the RTL8100C(L) controller.

PIFR = 00h (the PCI version 2.1 specification does not define any specific value for network devices).

**SCR: Sub-Class Register**

The Sub-class register is an 8-bit register that identifies the function of the RTL8100C(L). SCR = 00h indicates that the RTL8100C(L) is an Ethernet controller.

**BCR: Base-Class Register**

The Base-Class Register is an 8-bit register that broadly classifies the function of the RTL8100C(L). BCR = 02h indicates that the RTL8100C(L) is a network controller.

**CLS: Cache Line Size**

Reads will return a 0, writes are ignored.

**LTR: Latency Timer Register**

Specifies, in units of PCI bus clocks, the value of the latency timer of the RTL8100C(L).

When the RTL8100C(L) asserts FRAMEB, its latency timer starts to count. If the RTL8100C(L) deasserts FRAMEB prior to count expiration, the contents of the latency timer are ignored. Otherwise, after the count expires, the RTL8100C(L) initiates transaction termination as soon as its GNTB is deasserted. Software is able to read or write, and the default value is 00H.

**HTR: Header Type Register**

Reads will return a 0, writes are ignored.

**BIST: Built-In Self Test**

Reads will return a 0, writes are ignored.

**IOAR: Input Output Address Register**

This register specifies the base IO address that is required to build an address map during configuration. It also specifies the number of bytes required as well as an indication that it can be mapped into IO space.

**Table 43. Base IO Address**

Bit	Symbol	Description
31-8	IOAR31-8	Base IO Address. This is set by software to the base IO address for the operational register map.
7-2	IOSIZE	IO Size. Read back as 0. This allows the PCI bridge to determine that the RTL8100C(L) requires 256 bytes of IO space.
1	-	Reserved.
0	IOIN	IO Space Indicator. Read only. Set to 1 by the RTL8100C(L) to indicate that it is capable of being mapped into IO space.

**MEMAR: Memory Address Register**

This register specifies the base memory address for memory accesses to the RTL8100C(L) operational registers. This register must be initialized prior to accessing any of the RTL8100C(L)'s registers with memory access.

**Table 44. Base Memory Address for Memory Accesses**

Bit	Symbol	Description
31-8	MEM31-8	Base Memory Address. This is set by software to the base address for the operational register map.
7-4	MEMSIZE	Memory Size. These bits return 0, which indicates that the RTL8100C(L) requires 256 bytes of Memory Space.
3	MEMPF	Memory Pre-Fetchable. Read only. Set to 0 by the RTL8100C(L).
2-1	MEMLOC	Memory Location Select. Read only. Set to 0 by the RTL8100C(L). This indicates that the base register is 32-bits wide and can be placed anywhere in the 32-bit memory space.
0	MEMIN	Memory Space Indicator. Read only. Set to 0 by the RTL8100C(L) to indicate that it is capable of being mapped into memory space.

**SVID: Subsystem Vendor ID**

This field will be set to a value corresponding to the PCI Subsystem Vendor ID in the external EEPROM. If there is no EEPROM, this field will default to a value of 10ECh (Realtek Semiconductor's PCI Subsystem Vendor ID).

**SMID: Subsystem ID.**

This field will be set to a value corresponding to PCI Subsystem ID in the external EEPROM. If there is no EEPROM, this field will default to a value of 8139h.

**BMAR: Bus Master Address Register**

This register is disabled in the RTL8100C(L).

**ILR: Interrupt Line Register**

The Interrupt Line Register is an 8-bit read-only register used to indicate the routing of the interrupt. It is written by the POST software to set an interrupt line for the RTL8100C(L).

**IPR: Interrupt Pin Register (Read Only IPR = 01H)**

The Interrupt Pin register is an 8-bit register indicating the interrupt pin used by the RTL8100C(L). The RTL8100C(L) uses an INTA interrupt pin.

**MNGNT: Minimum Grant Timer (Read Only)**

Specifies the minimum burst period the RTL8100C(L) needs at a 33MHz clock rate, in units of 1/4 microseconds. This field will be set to a value from the external EEPROM. If there is no EEPROM, this field will default to a value of 20h.

**MXLAT: Maximum Latency Timer (Read Only)**

Indicates how long the RTL8100C(L) is allowed access to the PCI bus, in units of 1/4 microseconds. This field will be set to a value from the external EEPROM. If there is no EEPROM, this field will default to a value of 20h.

## 6.4. Default Values after Power-on (RSTB Asserted)

**Table 45. Default Values after Power-On (RSTB Asserted)**

No.	Name	Type	Bit7	Bit6	Bit5	Bit4	Bit3	Bit2	Bit1	Bit0
00h	VID	R	1	1	1	0	1	1	0	0
01h		R	0	0	0	1	0	0	0	0
02h	DID	R	0	0	1	1	1	0	0	1
03h		R	1	0	0	0	0	0	0	1
04h	Command	R	0	0	0	0	0	0	0	0
		W	-	PERRSP	-	-	-	BMEN	MEMEN	IOEN
05h		R	0	0	0	0	0	0	0	0
		W	-	-	-	-	-	-	-	SERREN
06h	Status	R	0	0	0	NewCap	0	0	0	0
07h		R	0	0	0	0	0	0	1	0
		W	DPERR	SSERR	RMABT	RTABT	STABT	-	-	DPD
08h	Revision ID	R	0	0	0	0	0	0	0	0
09h	PIFR	R	0	0	0	0	0	0	0	0
0Ah	SCR	R	0	0	0	0	0	0	0	0
0Bh	BCR	R	0	0	0	0	0	0	1	0
0Ch	CLS	R	0	0	0	0	0	0	0	0
0Dh	LTR	R	0	0	0	0	0	0	0	0
		W	LTR7	LTR6	LTR5	LTR4	LTR3	LTP2	LTR1	LTR0
0Eh	HTR	R	0	0	0	0	0	0	0	0
0Fh	BIST	R	0	0	0	0	0	0	0	0
10h	IOAR	R	0	0	0	0	0	0	0	1
11h		R/W	0	0	0	0	0	0	0	0
12h		R/W	0	0	0	0	0	0	0	0
13h		R/W	0	0	0	0	0	0	0	0
14h	MEMAR	R	0	0	0	0	0	0	0	0
15h		R/W	0	0	0	0	0	0	0	0
16h		R/W	0	0	0	0	0	0	0	0
17h		R/W	0	0	0	0	0	0	0	0
18h-2Bh	RESERVED (ALL 0)									
2Ch	SVID	R	1	1	1	0	1	1	0	0
2Dh		R	0	0	0	1	0	0	0	1
2Eh	SMID	R	0	0	1	1	1	0	0	1
2Fh		R	1	0	0	0	0	0	0	1
30h-33h	Reserved	-	-	-	-	-	-	-	-	-
34h	Cap-Ptr	R	Ptr7	Ptr6	Ptr5	Ptr4	Ptr3	Ptr2	Ptr1	Ptr0
35h-3Bh	RESERVED (ALL 0)									
3Ch	ILR	R/W	0	0	0	0	0	0	0	0
3Dh	IPR	R	0	0	0	0	0	0	0	1
3Eh	MNGNT	R	0	0	1	0	0	0	0	0
3Fh	MXLAT	R	0	0	1	0	0	0	0	0
40h-FFh	-	RESERVED (ALL 0)								

## 6.5. PCI Power Management Functions

The RTL8100C(L) complies with ACPI (Rev 1.1), PCI Power Management (Rev 1.1), and the Device Class Power Management Reference Specification (V1.0a), such as to support an Operating System-Directed Power Management (OSPM) environment. To support this, the RTL8100C(L) provides the following capabilities:

- The RTL8100C(L) can monitor the network for a Wakeup Frame (AMD Magic Packet, LinkChg, Microsoft® wake-up frame), and notify the system via PME# should such a packet or event arrive. Then the system can be restored to a working state to process incoming jobs.
- The RTL8100C(L) can be isolated from the PCI bus automatically via the auxiliary power circuit when the PCI bus is in B3 state, i.e. the power on the PCI bus is removed. The RTL8100C(L) can be disabled when needed by pulling the isolate pin low to 0V.

### 6.5.1. Power Down Mode

When the RTL8100C(L) is in power down mode (D1 ~ D3):

- The Rx state machine is stopped and the RTL8100C(L) monitors the network for wakeup events. The RTL8100C(L) will not reflect the status of any incoming packets in the ISR register and will not receive any packets into the Rx FIFO.
- The FIFO status and the packets that are already in the Rx FIFO before entering power down mode are held by the RTL8100C(L) during power down mode.
- Transmission is stopped. PCI bus master mode is stopped. The Tx FIFO buffer is held.
- After restoration to a D0 state, PCI bus master mode transfers data to the Tx FIFO that was not moved into the Tx FIFO before the last break. A packet that was not transmitted completely before power down mode is transmitted again.

#### **D3cold\_support\_PME bit (bit15, PMC register) & Aux\_I\_b2:0 (bit8:6, PMC register) in PCI configuration space**

- If 9346 D3cold\_support\_PME bit (bit15, PMC) = 1, the above 4 bits depend on the existence of Aux power.
- If 9346 D3cold\_support\_PME bit (bit15, PMC) = 0, the above 4 bits are all 0's.

Examples:

1. 9346 D3c\_support\_PME = 1

- If Aux. power exists, then PMC in PCI config space is the same as 9346 PMC, i.e. if 9346 PMC = C2 F7, then PCI PMC = C2 F7.
- Aux. power is absent, then PMC in PCI config space is the same as 9346 PMC except the above 4 bits are all 0's. I.e. if 9346 PMC = C2 F7, then PCI PMC = 02 76.

*Note: In this case, if wakeup support is desired when the main power is off, it is suggested that the EEPROM PMC be set to: C2 F7 (Realtek default value). It is not recommended to set the D0\_support\_PME bit to 1.*

2. 9346 D3c\_support\_PME = 0,
- If Aux. power exists, then PMC in PCI config space is the same as 9346 PMC, i.e. if 9346 PMC = C2 77, then PCI PMC = C2 77.
  - If Aux. power is absent, then PMC in PCI config space is the same as 9346 PMC except the above 4 bits are all 0's, i.e. if 9346 PMC = C2 77, then PCI PMC = 02 76.

*Note: In this case, if wakeup support is not desired when main power is off, it is suggested that the 9346 PMC be set to 02 76. It is not recommended to set the D0\_support\_PME bit to 1.*

### Link Wakeup

Link Wakeup occurs when the following conditions are met:

- The LinkUp bit (CONFIG3#4) is set to 1, the PMEn bit (CONFIG1#0) is set to 1, and the RTL8100C(L) is in isolation state, or the PME# can be asserted in the current power state.
- The Link status is re-established.

### Magic Packet Wakeup

A Magic Packet Wakeup occurs when the following conditions are met:

- The destination address of the received Magic Packet matches.
- The received Magic Packet does not contain a CRC error.
- The Magic bit (CONFIG3#5) is set to 1, the PMEn bit (CONFIG1#0) is set to 1, and the RTL8100C(L) is in isolation state, or the PME# can be asserted in the current power state.
- The Magic Packet pattern matches, i.e. 6 \* FFh + MISC (can be none) + 16 \* DID (Destination ID) in any part of a valid (Fast) Ethernet packet.

A Wakeup Frame event occurs only when the following conditions are met:

- The destination address of the received Wakeup Frame matches.
- The received Wakeup Frame does not contain a CRC error.
- The PMEn bit (CONFIG1#0) is set to 1.
- The 8-bit CRC\* (or 16-bit CRC\*\*) of the received Wakeup Frame matches with the 8-bit CRC (or 16-bit CRC) of the sample Wakeup Frame pattern received from the local machine's OS.
- The last masked byte\*\*\* of the received Wakeup Frame matches with the last masked byte\*\*\* of the sample Wakeup Frame pattern provided by the local machine's OS (In Long Wakeup Frame mode, the last masked byte field is replaced with the high byte of the 16-bit CRC).

#### \*8-bit CRC:

8-bit CRC logic is used to generate an 8-bit CRC from the masked bytes of the received Wakeup Frame packet within offset 12 to 75. Software should calculate the 8-bit Power Management CRC for each specific sample wakeup frame and store the calculated CRC in the corresponding CRC register for the RTL8100C(L) to check whether there is a Wakeup Frame coming in.

**\*\*16-bit CRC: (Long Wakeup Frame mode, the mask bytes cover from offset 0 to 127)**

*Long Wakeup Frame:* The RTL8100C(L) also supports 3 long Wakeup Frames. If the range of mask bytes of the sample Wakeup Frame, passed down by the OS to the driver, exceeds the range from offset 12 to 75, the related registers of wakeup frame 2 and 3 can be merged to support one long wakeup frame by setting the LongWF (bit0, CONFIG4). Thus, the range of effective mask bytes extends from offset 0 to 127. The low byte and high byte of the calculated 16-bit CRC should be put into register CRC2 and LSBCRC2 respectively. The mask bytes (16 bytes) should be stored in register Wakeup2 and Wakeup3. The CRC3 and LSBCRC3 have no meaning in this case and should be reset to 0. Long Wakeup Frame pairs are frames 4 and 5, and frames 6 and 7. The CRC5, CRC7, LSBCRC5, and LSBCRC7 have no meaning in this case and should be set to 0 if the RTL8100C(L) is to support long Wakeup Frames. The RTL8100C(L) supports 2 normal wakeup frames and 3 long wakeup frames.

**\*\*\*Last Masked Byte:**

The last byte of the masked bytes of the received Wakeup Frame packet within offset 12 to 75 (in 8-bit CRC mode) should match the last byte of the masked bytes of the sample Wakeup Frame provided by the local machine's OS.

**PME# Signal**

The PME# signal is asserted only when the following conditions are met:

- The PMEn bit (bit0, CONFIG1) is set to 1.
- The PME\_En bit (bit8, PMCSR) in PCI Configuration Space is set to 1.
- The RTL8100C(L) may assert PME# in current power state, or when the RTL8100C(L) is in isolation state. Refer to 6.1 PCI Configuration Space Table, page 38, PME\_Support (bit15-11) of the PMC register.
- A Magic Packet, LinkChg, or Wakeup Frame event has occurred.

\* Writing a 1 to the PME\_Status (bit15) of PMCSR register in the PCI Configuration Space will clear this bit and cause the RTL8100C(L) to stop asserting a PME# (if enabled).

When the RTL8100C(L) is in power down mode, e.g. D1-D3, the IO, and MEM are all disabled. After RST# is asserted, the power state must be changed to D0 if the original power state was D3<sub>cold</sub>. There is no hardware enforced delays in the RTL8100C(L)'s power state. When in ACPI mode, the RTL8100C(L) does not support PME from D0 owing to the PMC register setting (this setting comes from EEPROM).

### **LWAKE Signal**

The RTL8100C(L) also supports the LAN WAKE-UP function. The LWAKE pin is used to notify the motherboard to execute the wake-up process whenever the RTL8100C(L) receives a wakeup event, such as a Magic Packet.

The LWAKE signal is asserted according to the following setting:

- LWPME bit (bit4, CONFIG4)
  - 0: LWAKE is asserted whenever a wakeup event occurs
  - 1: LWAKE can only be asserted when PMEB is asserted and ISOLATEB is low
- Bit1 of DELAY byte (offset 1Fh, EEPROM)
  - 0: LWAKE signal is disabled
  - 1: LWAKE signal is enabled

## **6.6. VPD (Vital Product Data)**

Bit 31 of the VPD is used to issue VPD read/write commands and is also a flag used to indicate whether the transfer of data between the VPD data register and the 93C46 has completed or not.

1. Write VPD register (write data to the 93C46)  
Write the flag bit to 1 at the same time the VPD address is written. When the flag bit is set to 0 by the RTL8100C(L), the VPD data (all 4 bytes) has been transferred from the VPD data register to the 93C46.
2. Read VPD register (read data from the 93C46)  
Write the flag bit to a zero at the same time the VPD address is written. When the flag bit is set to one by the RTL8100C(L), the VPD data (all 4 bytes) has been transferred from the 93C46 to the VPD data register.



## **7. Functional Description**

### ***7.1. Transmit Operation***

The host CPU initiates a transmit by storing an entire packet of data in one of the descriptors in the main memory. When the entire packet has been transferred to the Tx buffer, the RTL8100C(L) is instructed to move the data from the Tx buffer to the internal transmit FIFO in PCI bus master mode. When the transmit FIFO contains a complete packet or is filled to the programmed threshold level, the RTL8100C(L) begins packet transmission.

### ***7.2. Receive Operation***

The incoming packet is placed in the RTL8100C(L)'s Rx FIFO. Concurrently, the RTL8100C(L) performs address filtering of multicast packets according to the hash algorithms. When the amount of data in the Rx FIFO reaches the level defined in the Receive Configuration Register, the RTL8100C(L) requests the PCI bus to begin transferring the data to the Rx buffer in PCI bus master mode.

### ***7.3. Wander Compensation***

The 8100C(L) is ANSI TP-PMD compliant and supports Input Wander and Base Line Wander (BLW) compensation in 100Base-TX mode. The 8100C(L) does not require external attenuation circuitry at its receive inputs, RD+/- . It accepts TP-PMD compliant waveforms directly, requiring only 100Ω termination and a 1:1 transformer.

BLW is the change in the average DC content, over time, of an AC coupled digital transmission over a given transmission medium and is a result of the interaction between the low frequency components of a transmitted bit stream and the frequency response of the AC coupling component(s) within the transmission system. If the low frequency content of the digital bit stream goes below the low frequency pole of the AC coupling transformers, then the droop characteristics of the transformers will dominate, resulting in potentially serious BLW. If BLW is not compensated, packet loss can occur.

### ***7.4. Signal Detect***

The 8100C(L) supports signal detect in 100Base-TX mode. The reception of normal 10Base-T link pulses and fast link pulses (defined by IEEE 802.3u Auto-negotiation) by the 100Base-TX receiver do not cause the 8100C(L) to assert signal detect.

The signal detect function of the 8100C(L) is incorporated to meet the specifications mandated by the ANSI FDDI TP-PMD standard as well as the IEEE 802.3 100Base-TX standard for both voltage thresholds and timing parameters.

## ***7.5. Line Quality Monitor***

The line quality monitor function is available in 100Base-TX mode. It is possible to determine the amount of Equalization being used by accessing certain test registers with the DSP engine. This provides a crude indication of connected cable length. This function allows for a quick and simple verification of the line quality in that any significant deviation from an expected register value (based on a known cable length) would indicate that the signal quality has deviated from the expected nominal case.

## ***7.6. Clock Recovery Module***

The Clock Recovery Module (CRM) is supported in 100Base-TX mode. The CRM accepts 125Mbps MLT-3 data from the equalizer. The DPLL locks onto the 125Mbps data stream and extracts a 125MHz recovered clock. The extracted and synchronized clock and data are used as required by the synchronous receive operations.

## ***7.7. Loopback Operation***

Loopback mode is normally used to verify that the logic operations up to the Ethernet cable function correctly. In loopback mode for 100Mbps, the RTL8100C(L) takes frames from the transmit descriptor and transmits them up to internal Twister logic.

## ***7.8. Tx Encapsulation***

While operating in 100Base-TX mode, the RTL8100C(L) encapsulates the frames that it transmits according to the 4B/5B code-groups table. The changes to the original packet data are listed below:

1. The first byte of the preamble in the MAC frame is replaced with the JK symbol pair.
2. After the CRC, the TR symbol pair is inserted.

## ***7.9. Collision***

If the RTL8100C(L) is not in full-duplex mode, a collision event occurs when the receive input is not idle while the RTL8100C(L) transmits. If the collision was detected during the preamble transmission, a jam pattern is transmitted after completing the preamble (including the JK symbol pair).

## ***7.10. Rx Decapsulation***

The RTL8100C(L) continuously monitors the network when reception is enabled. When activity is recognized it starts to process the incoming data.

After detecting receive activity on the line, the RTL8100C(L) starts to process the preamble bytes based on the mode of operation.

While operating in 100Base-TX mode, the RTL8100C(L) expects the frame to start with the symbol pair JK in the first byte of the 8-byte preamble.

The RTL8100C(L) checks the CRC bytes and checks whether the packet data ends with the TR symbol pair. If not, the RTL8100C(L) reports an RSR CRC error.

The RTL8100C(L) reports an RSR CRC error in 100Base-TX mode if an invalid symbol (4B/5B Table) is received in the middle of the frame. The RSR<ISR> bit also sets.

## ***7.11. Flow Control***

The RTL8100C(L) supports IEEE 802.3X flow control for improved performance in full-duplex mode. It detects PAUSE packets to achieve flow control tasks.

### **7.11.1. Control Frame Transmission**

When the RTL8100C(L) detects that its free receive buffer is less than 3K bytes, it sends a PAUSE packet with `pause_time` (=FFFFh) to inform the source station to stop transmission for the specified period of time. After the driver has processed the packets in the receive buffer and updated the boundary pointer, the RTL8100C(L) sends another PAUSE packet with `pause_time` (=0000h) to wake up the source station to restart transmission.

### **7.11.2. Control Frame Reception**

The RTL8100C(L) enters a backoff state for a specified period of time when it receives a valid PAUSE packet with `pause_time` (=n). If the PAUSE packet is received while the RTL8100C(L) is transmitting, the RTL8100C(L) starts to back off after the current transmission completes. The RTL8100C(L) is free to transmit the next packet when it receives a valid PAUSE packet with `pause_time` (=0000h) or the backoff timer (=n\*512 bit time) elapses.

*Note: The PAUSE operation cannot be used to inhibit transmission of MAC Control frames (e.g. PAUSE packet). NWay flow control capability can be disabled. Refer to section 5.37 EEPROM (93C46) Contents, page 35.*

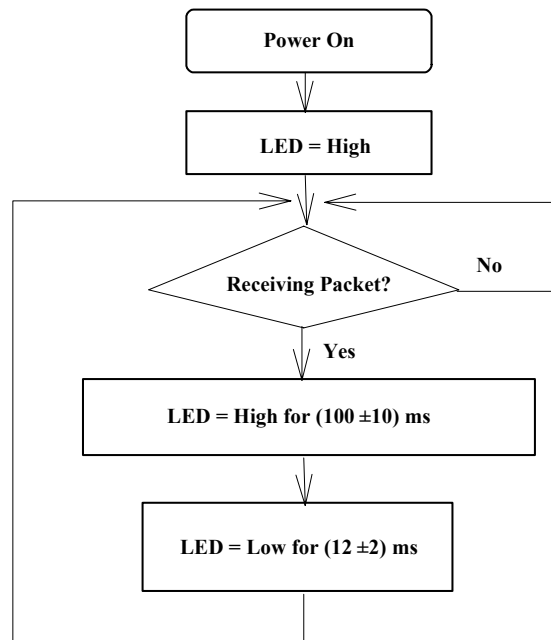
## 7.12. LED Functions

### 7.12.1. 10/100Mbps Link Monitor

The Link Monitor senses whether a station is connected and monitors link integrity.

*Note: In 10/100Mbps mode, LED function is the same as that of the RTL8139C(L).*

### 7.12.2. LED\_RX



**Figure 3. LED\_RX**

### 7.12.3. LED\_TX

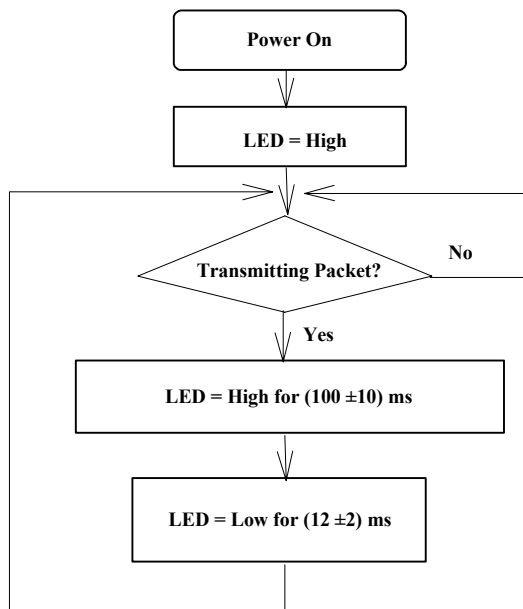


Figure 4. LED\_TX

### 7.12.4. LED\_TX+LED\_RX

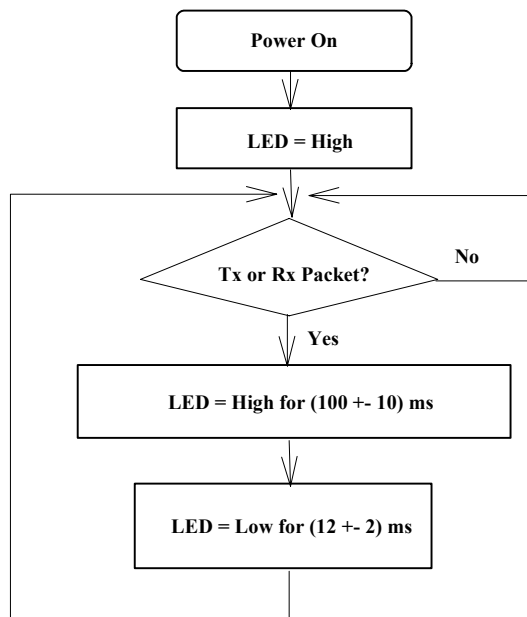


Figure 5. LED\_TX+LED\_RX

## 8. Characteristics

### 8.1. Thermal Characteristics

**Table 46. Thermal Characteristics**

Parameter	Minimum	Maximum	Units
Storage temperature	-55	+125	°C
Operating temperature	0	70	°C

### 8.2. DC Characteristics

#### 8.2.1. Supply Voltage ( $V_{CC} = 3.0V$ min. to $3.6V$ max.)

**Table 47. Supply Voltage (3.0V min. to 3.6V max.)**

Symbol	Parameter	Conditions	Minimum	Maximum	Units
$V_{OH}$	Minimum High Level Output Voltage.	$I_{OH} = -8mA$	$0.9 * V_{CC}$	$V_{CC}$	V
$V_{OL}$	Maximum Low Level Output Voltage.	$I_{OL} = 8mA$		$0.1 * V_{CC}$	V
$V_{IH}$	Minimum High Level Input Voltage.		$0.5 * V_{CC}$	$V_{CC} + 0.5$	V
$V_{IL}$	Maximum Low Level Input Voltage.		-0.5	$0.3 * V_{CC}$	V
$I_{IN}$	Input Current.	$V_{IN} = V_{CC}$ or GND	-1.0	1.0	$\mu A$
$I_{OZ}$	Tri-State Output Leakage Current.	$V_{OUT} = V_{CC}$ or GND	-10	10	$\mu A$
$I_{CC}$	Average Operating Supply Current.	$I_{OUT} = 0mA$		330	mA

#### 8.2.2. Supply Voltage ( $V_{DD25} = 2.3V$ min. to $2.7V$ max.)

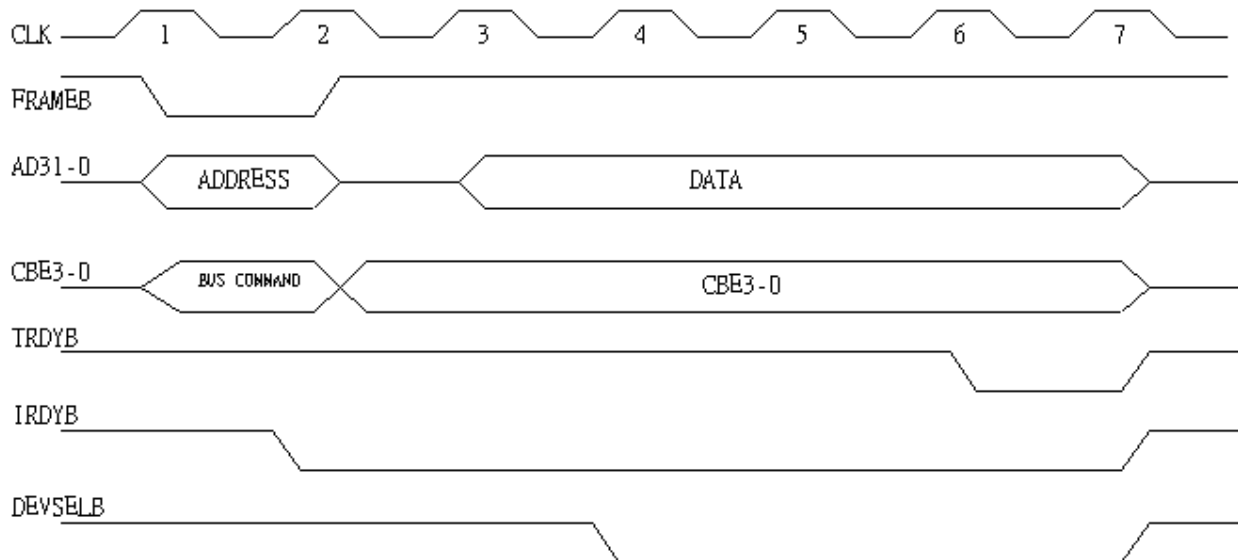
**Table 48. Supply Voltage (2.3V min. to 2.7V max.)**

Symbol	Parameter	Conditions	Minimum	Maximum	Units
$V_{OH}$	Minimum High Level Output Voltage.	$I_{OH} = -8mA$	$0.9 * V_{DD25}$	$V_{DD25}$	V
$V_{OL}$	Maximum Low Level Output Voltage.	$I_{OL} = 8mA$		$0.1 * V_{DD25}$	V
$V_{IH}$	Minimum High Level Input Voltage.		$0.5 * V_{DD25}$	$V_{DD25} + 0.5$	V
$V_{IL}$	Maximum Low Level Input Voltage.		-0.5	$0.3 * V_{DD25}$	V
$I_{IN}$	Input Current.	$V_{IN} = V_{DD25}$ or GND	-1.0	1.0	$\mu A$
$I_{OZ}$	Tri-State Output Leakage Current.	$V_{OUT} = V_{DD25}$ or GND	-10	10	$\mu A$
$I_{DD25}$	Average Operating Supply Current.	$I_{OUT} = 0mA$		40	mA

## 8.3. AC Characteristics

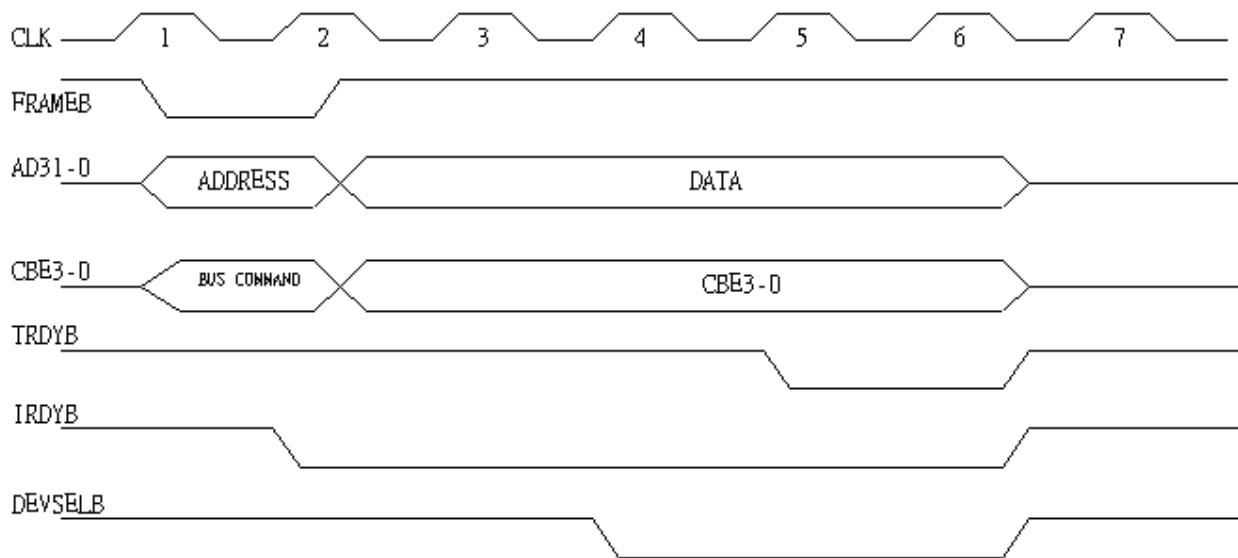
### 8.3.1. PCI Bus Operation Timing

#### Target Read

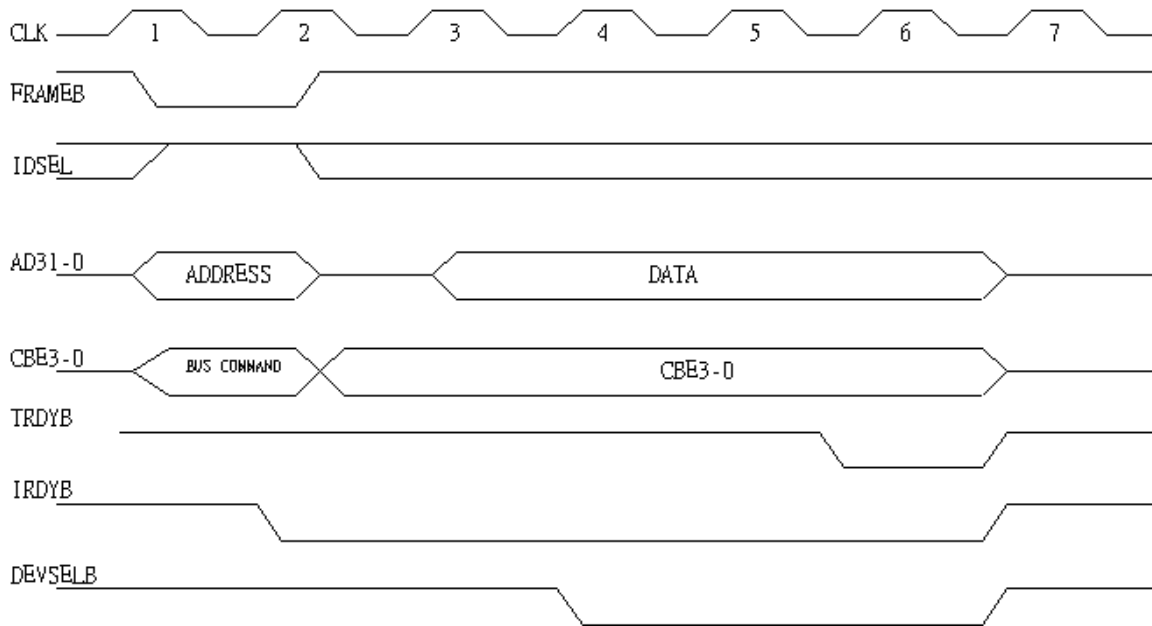
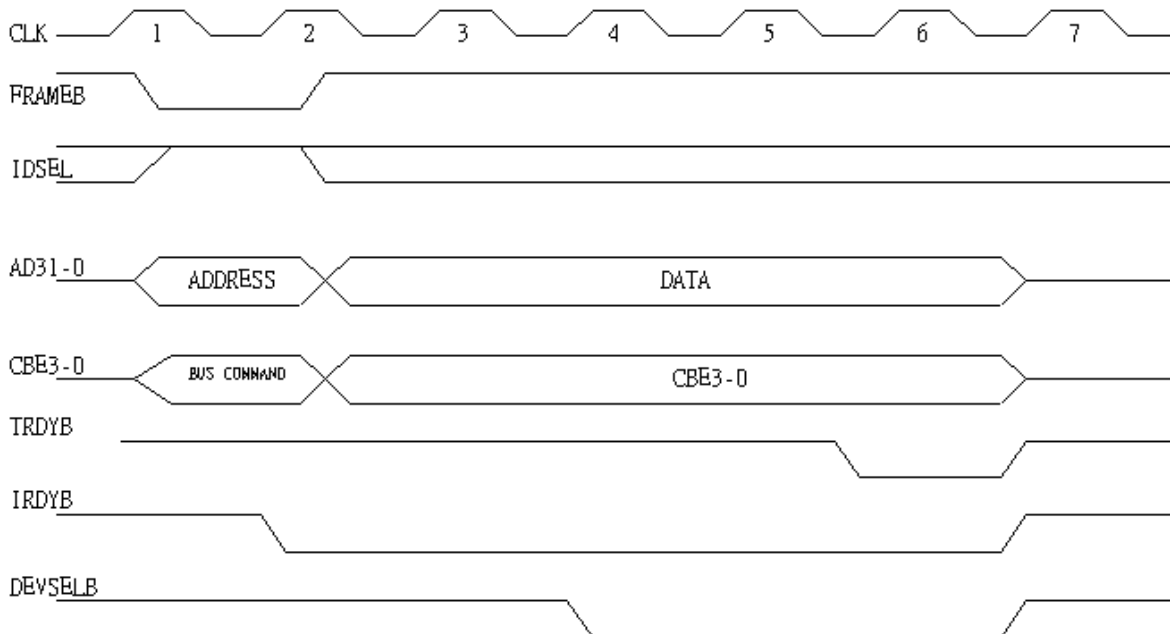


**Figure 6. Target Read**

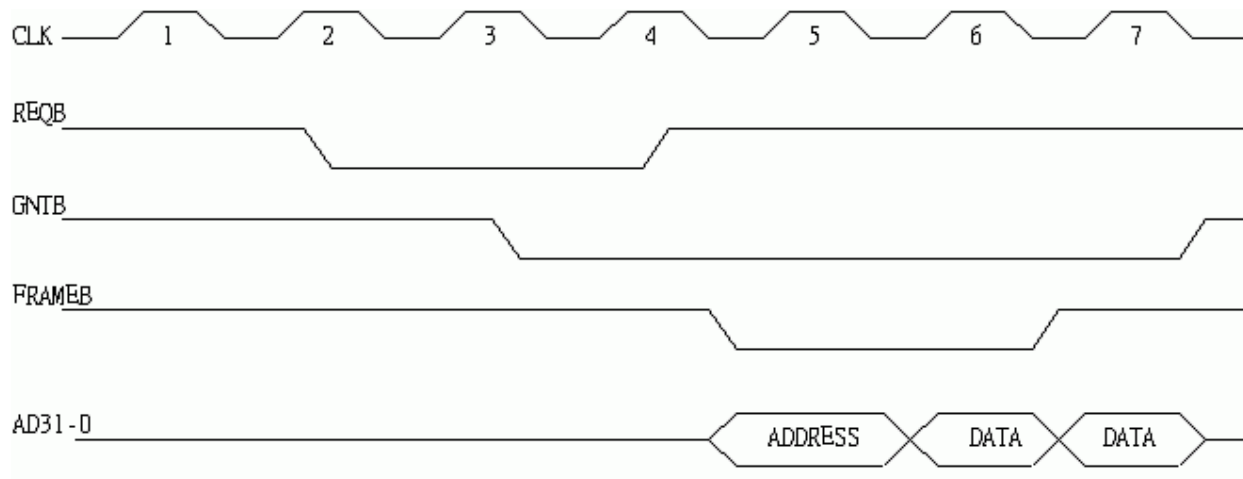
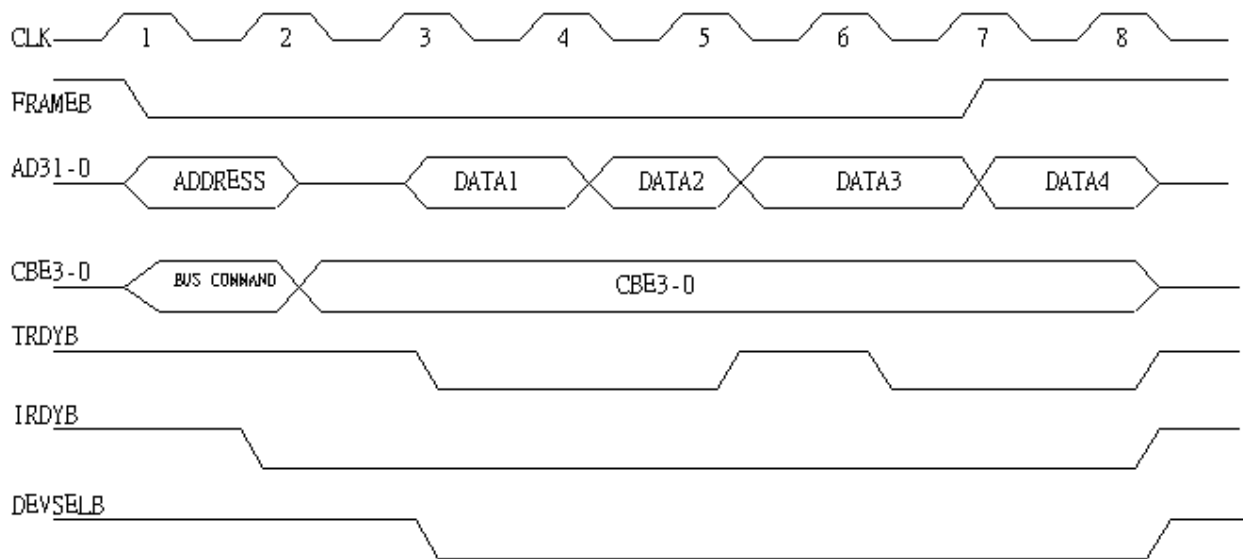
#### Target Write

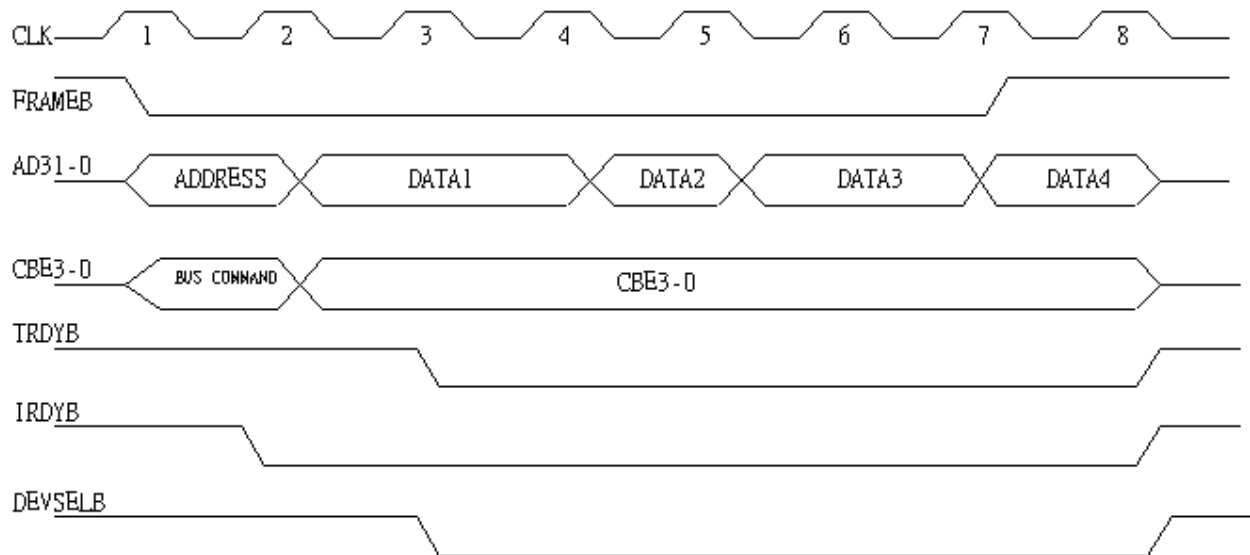
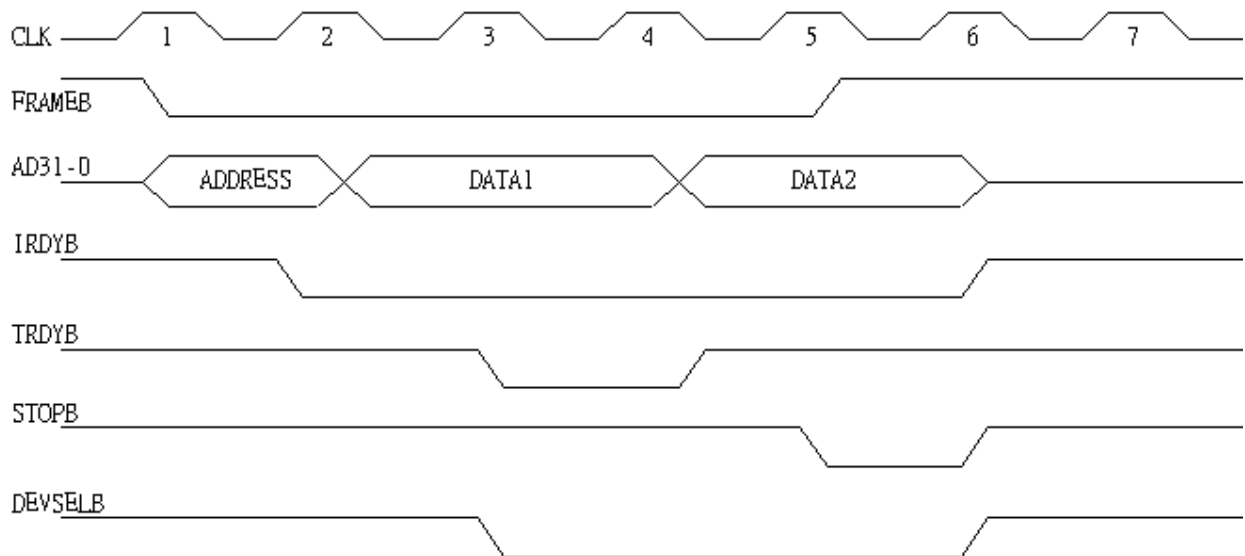


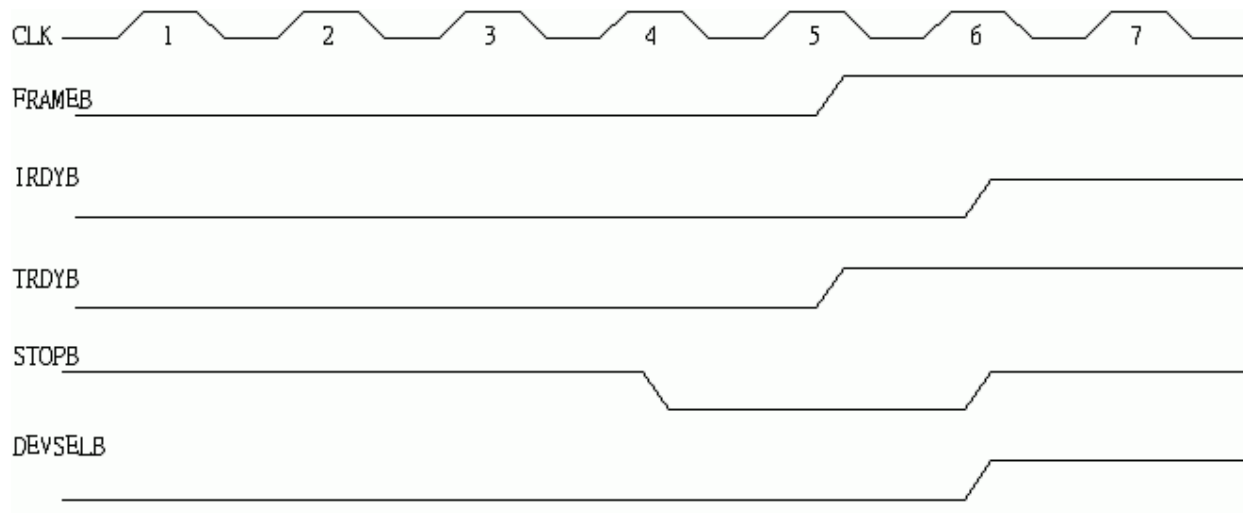
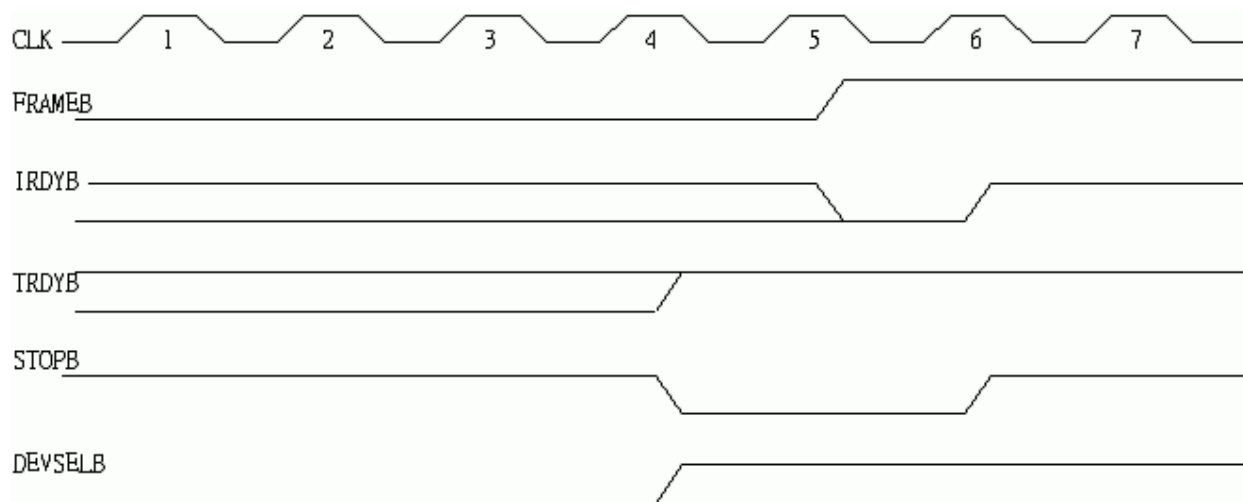
**Figure 7. Target Write**

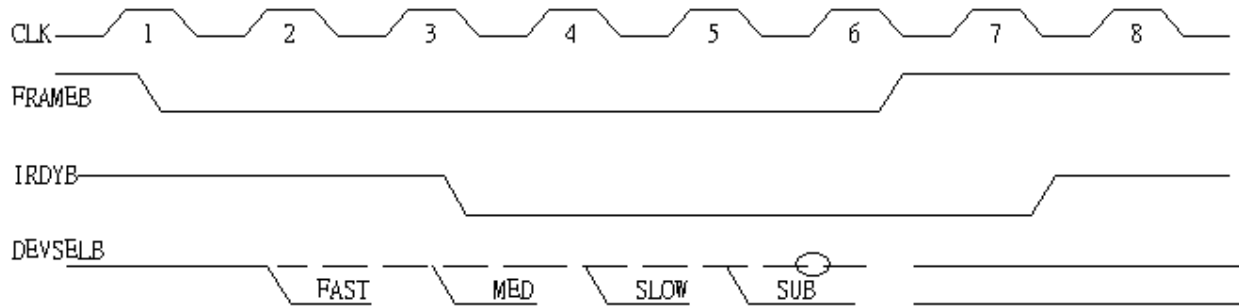
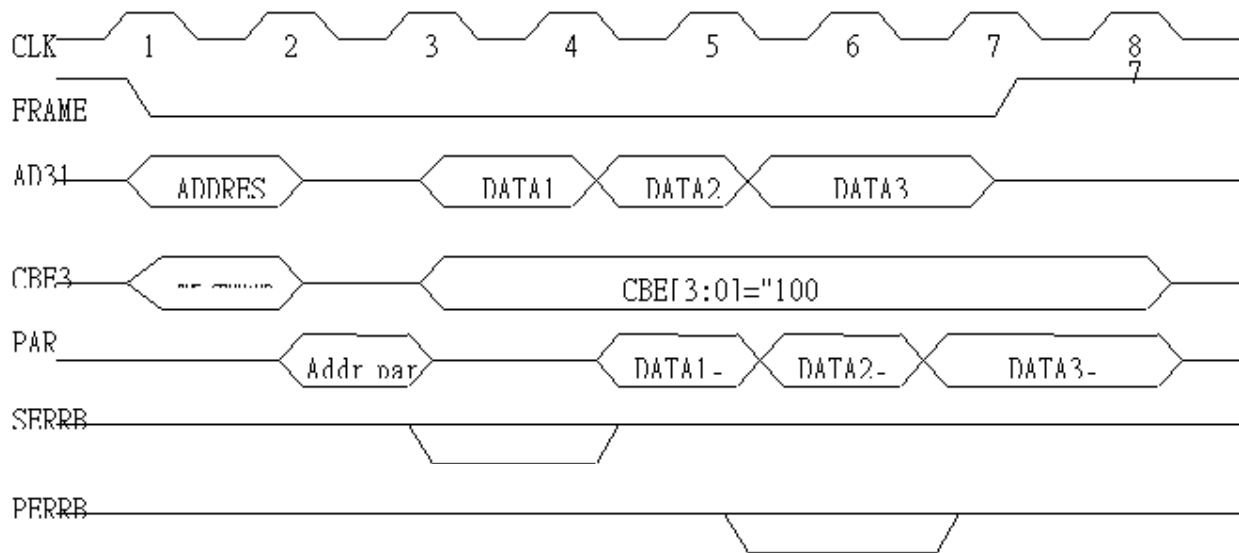
**Configuration Read**

**Figure 8. Configuration Read**
**Configuration Write**

**Figure 9. Configuration Write**



**Bus Arbitration**

**Figure 10. Bus Arbitration**
**Memory Read**

**Figure 11. Memory Read**

**Memory Write**

**Figure 12. Memory Write**
**Target Initiated Termination - Retry**

**Figure 13. Target Initiated Termination - Retry**

**Target Initiated Termination - Disconnect**

**Figure 14. Target Initiated Termination - Disconnect**
**Target Initiated Termination - Abort**

**Figure 15. Target Initiated Termination - Abort**

**Master Initiated Termination – Abort**

**Figure 16. Master Initiated Termination – Abort**
**Parity Operation - One Example**

**Figure 17. Parity Operation - One Example**

## 9. Application Information

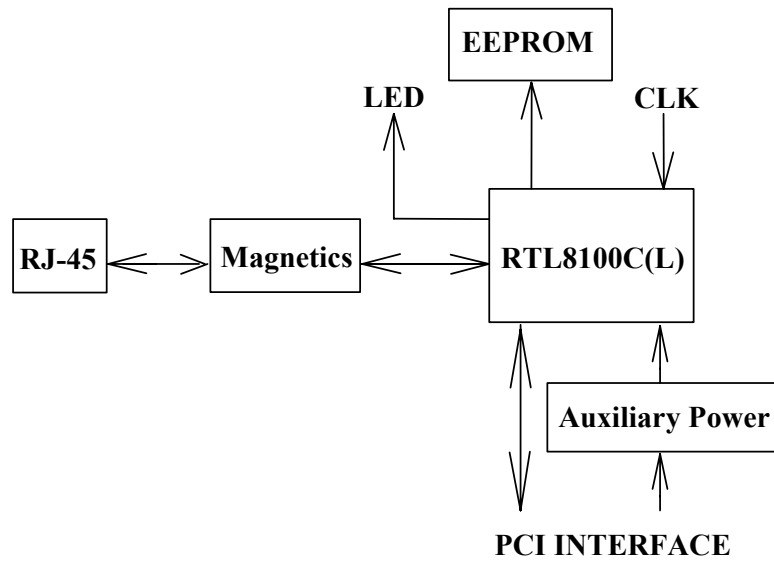
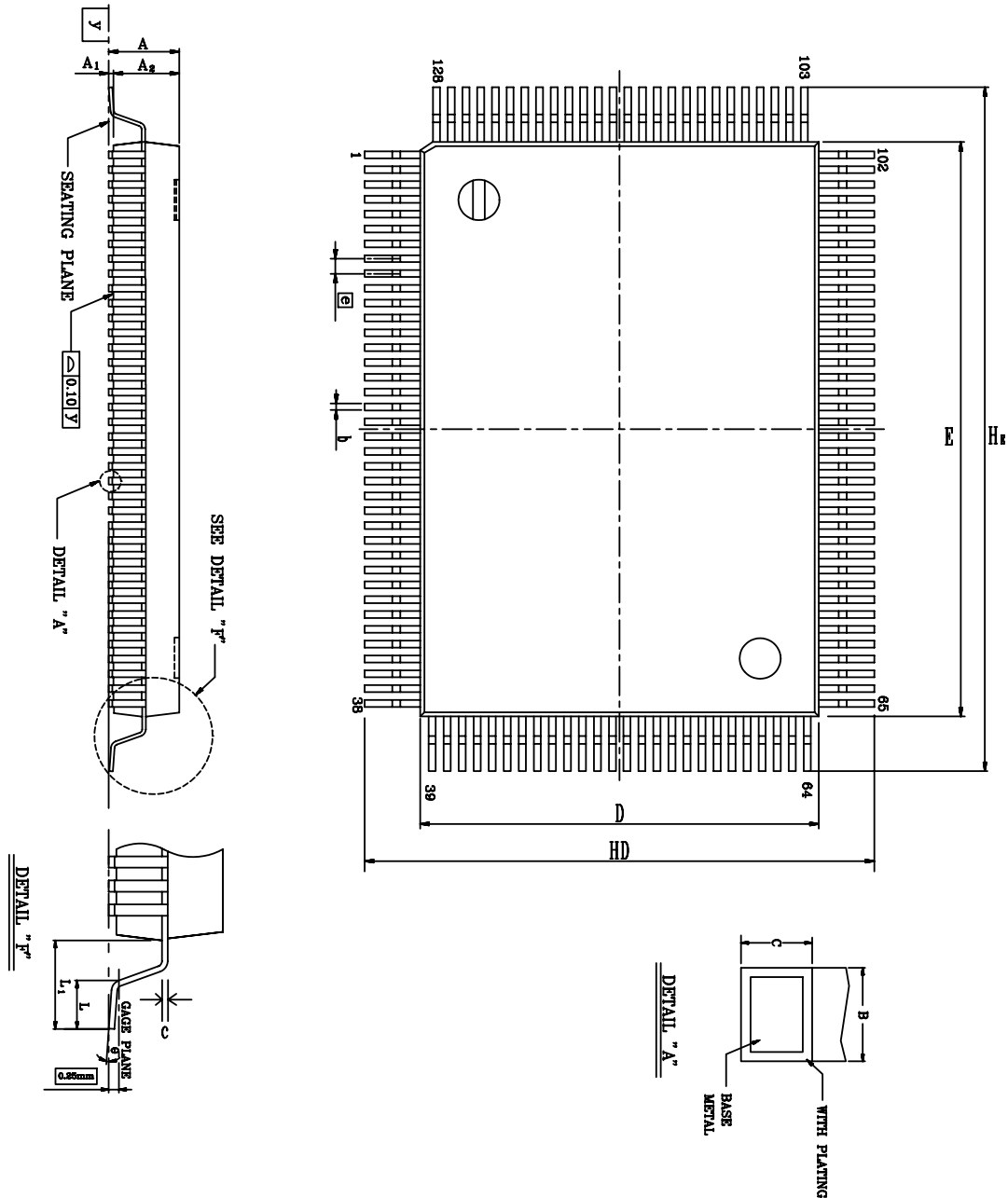


Figure 18. Application Information

## 10. Mechanical Dimensions

### 10.1. RTL8100C 128-Pin QFP



See the Mechanical Dimensions notes on the next page.

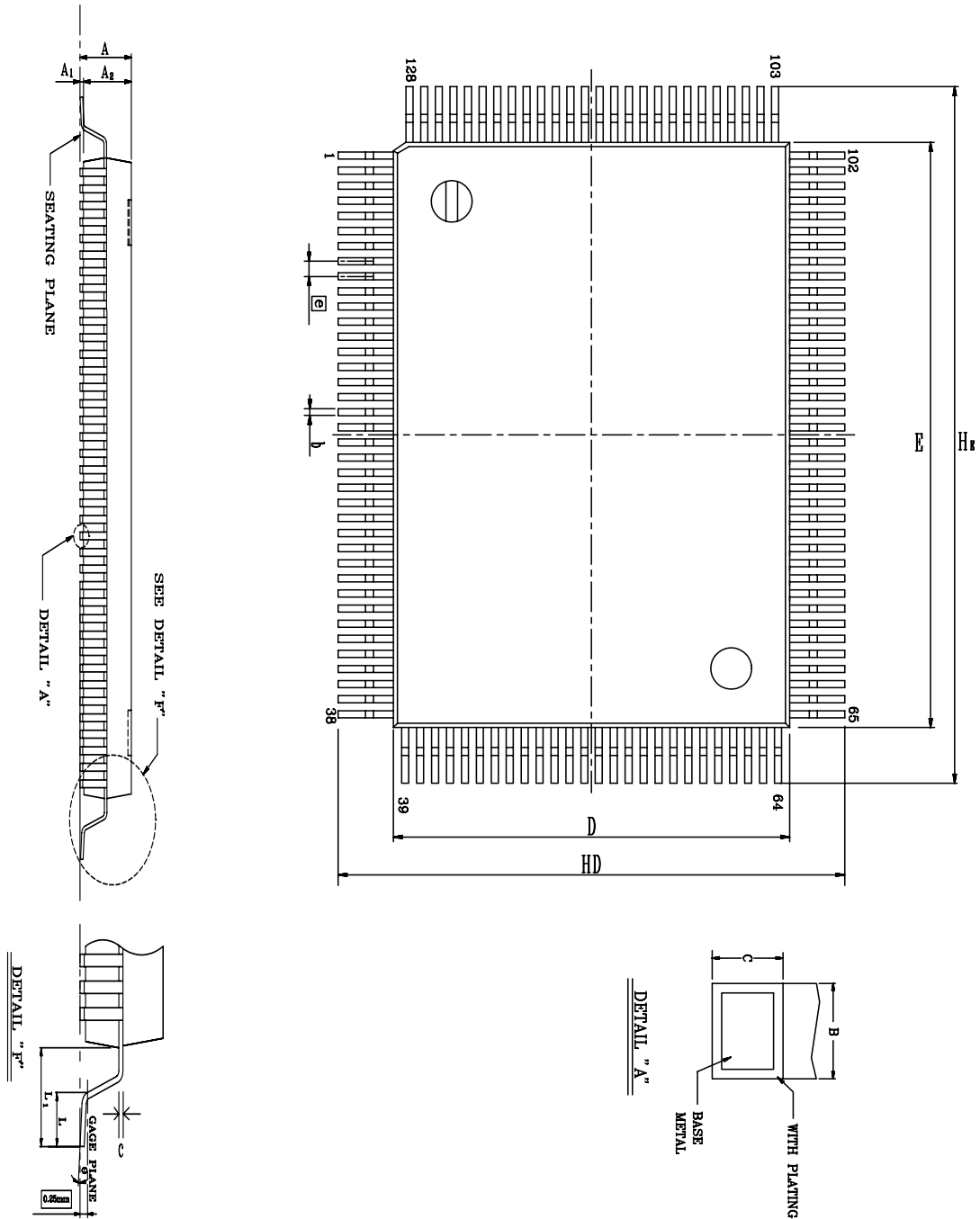
## 10.2. Notes for RTL8100C 128-Pin QFP

Symbol	Dimension in inch			Dimension in mm		
	Min	Type	Max	Min	Type	Max
<b>A</b>	-	-	0.134	-	-	3.40
<b>A1</b>	0.004	0.010	0.036	0.10	<b>0.25</b>	0.91
<b>A2</b>	0.102	0.112	0.122	2.60	<b>2.85</b>	3.10
<b>b</b>	0.005	0.009	0.013	0.12	<b>0.22</b>	0.32
<b>c</b>	0.002	0.006	0.010	0.05	<b>0.15</b>	0.25
<b>D</b>	0.541	0.551	0.561	13.75	<b>14.00</b>	14.25
<b>E</b>	0.778	0.787	0.797	19.75	<b>20.00</b>	20.25
$\epsilon$	0.010	0.020	0.030	0.25	<b>0.5</b>	0.75
<b>HD</b>	0.665	0.677	0.689	16.90	<b>17.20</b>	17.50
<b>HE</b>	0.902	0.913	0.925	22.90	<b>23.20</b>	23.50
<b>L</b>	0.027	0.035	0.043	0.68	<b>0.88</b>	1.08
<b>L1</b>	0.053	0.063	0.073	1.35	<b>1.60</b>	1.85
<b>y</b>	-	-	0.004	-	-	0.10
$\theta$	0°	-	12°	0°	-	12°

1. Dimension D & E do not include interlead flash.
2. Dimension b does not include dambar protrusion/intrusion.
3. Controlling dimension: Millimeter
4. General appearance spec. should be based on final visual inspection spec.

TITLE: <b>128 QFP</b> (14x20 mm) PACKAGE OUTLINE			
-CU L/F, FOOTPRINT 3.2 mm			
LEADFRAME MATERIAL :			
APPROVE		DOC. NO.	530-ASS-P004
		VERSION	1
		PAGE	OF
CHECK		DWG NO.	Q128 - 1
		DATE	
REALTEK SEMICONDUCTOR CORP.			

### 10.3. RTL8100CL 128-Pin LQFP



See the Mechanical Dimensions notes on the next page.



### 10.4. Notes for RTL8100CL 128-Pin LQFP

Symbol	Dimension in inch			Dimension in mm		
	Min	Type	Max	Min	Type	Max
<b>A</b>	-	-	0.067	-	-	1.70
<b>A1</b>	0.000	0.004	0.008	0.00	-	0.25
<b>A2</b>	0.051	0.055	0.059	1.30	<b>1.40</b>	1.50
<b>b</b>	0.006	0.009	0.011	0.15	<b>0.22</b>	0.29
<b>c</b>	0.004	-	0.006	0.09	-	0.20
<b>D</b>	0.541	0.551	0.561	13.75	<b>14.00</b>	14.25
<b>E</b>	0.778	0.787	0.797	19.75	<b>20.00</b>	20.25
<b>e</b>	-	0.020	BSC	-	0.50	BSC
<b>HD</b>	0.620	0.630	0.640	15.90	<b>16.00</b>	16.30
<b>HE</b>	0.855	0.866	0.877	21.70	<b>22.00</b>	22.30
<b>L</b>	0.016	0.024	0.031	0.45	<b>0.60</b>	0.75
<b>L1</b>	-	0.039	REF	-	1.00	REF
<b>θ</b>	0°	3.5°	9°	0°	3.5°	9°

- 1.Dimension b does not include dambar protrusion/intrusion.
- 2.Controlling dimension: Millimeter
- 3.General appearance spec. Should be based on final visual inspection spec.

TITLE: 128LD LQFP (14x20x1.4 mm*2) PACKAGE OUTLINE -CU L/F, FOOTPRINT 2.0 mm			
LEADFRAME MATERIAL:			
APPROVE		DOC. NO.	530-ASS-P004
		VERSION	1
		PAGE	OF
CHECK		DWG NO.	LQ128 - 1
		DATE	
REALTEK SEMICONDUCTOR CORP.			

## 11. Ordering Information

Part No.	Package	Status
RTL8100C	128-pin QFP	MP
RTL8100CL	128-pin LQFP	MP
RTL8100C-LF	128-pin QFP Lead (Pb)-Free	MP
RTL8100CL-LF	128-pin LQFP Lead (Pb)-Free	MP

### Realtek Semiconductor Corp.

#### Headquarters

No. 2, Industry East Road IX, Science-based  
Industrial Park, Hsinchu, 300, Taiwan, R.O.C.  
Tel: 886-3-5780211 Fax: 886-3-5776047  
www.realtek.com.tw