

# MCH/MGH Single and Dual DC/DC Converters

## 28 VOLT INPUT – 1.5 WATT

### FEATURES

- -55°C to +125°C operation
- 12 to 50 VDC input
- Fully isolated
- Magnetic feedback
- Fixed frequency 370 kHz typ.
- Topology – Current Mode Flyback
- 80 V for up to 120 ms transient protection (70 V for 15 V single and dual models)
- Inhibit function
- Indefinite short circuit protection
- Undervoltage lockout
- Up to 79% efficiency (MGH models)



### MODELS

#### VDC OUTPUT

SINGLES	DUALS
5	±5
5.2 (MCH)	±12
12	±15
15	

### MCH SERIES™ SINGLE & DUAL DC/DC CONVERTERS

With a miniature footprint of just 0.8 square inches, the MCH Series™ of DC/DC converters delivers 1.5 watts of output power while saving significant board real estate. The wide input voltage range of 12 to 50 VDC accepts the varying voltages of military, aerospace, or space bus power and tightly regulates output voltages to protect downstream components. Transient protection of 80 volts for up to 120 milliseconds exceeds the requirements of MIL-STD-704A for the 5, 5.2, and 12 volt single models and the 12 volt dual model. The 15 volt single and dual converters will withstand transients of up to 70 volts for up to 120 milliseconds.

### CONVERTER DESIGN

MCH Series DC/DC converters incorporate a continuous flyback topology with a constant switching frequency of approximately 370 kHz. Current-mode pulse width modulation (PWM) provides output voltage regulation. Output error voltage is magnetically fed back to the input side of the PWM to regulate output voltage. Regulation is also affected by the load; refer to the Electrical Characteristics tables on the following pages.

Dual models regulate the negative output with magnetic coupling to the positive output. Up to 80% of the total load may be on one output providing that the other output carries a minimum of 20% of the total load. The dual models can be used at double the output voltage by connecting the load between positive and negative outputs, leaving the common unconnected. (ex: MCH2805D can be used as a 10 VDC output.)

### INHIBIT FUNCTION

When an open collector TTL logic low is applied to the inhibit terminal, pin 7, the converter shuts down and lowers the output voltage to near zero and input current to as low as 2.3 mA. Leaving the terminal open or applying an open collector TTL logic high will enable the converter.

### PROTECTION FEATURES

Undervoltage lockout prevents the MCH Series converters from operating below approximately 8 VDC input voltage to keep system current levels smooth, especially during initialization or re-start operations. All models include a soft-start function to prevent large current draw and minimize overshoot. The converters also provide short circuit protection by restricting the current.

### MIL-STD-461

Use Interpoint's FMSA-461 EMI filter to pass the CE03 requirements of MIL-STD-461C.

### CONVENIENT PACKAGING

The MCH Series converters are packaged in hermetically sealed, projection-welded metal cases which provide EMI/RFI shielding.

# MCH/MGH Single and Dual DC/DC Converters

## 28 VOLT INPUT – 1.5 WATT

### MGH SERIES™ SINGLE & DUAL DC/DC CONVERTERS

The MGH Series™ of DC/DC converters delivers 1.5 watts of output power in a labor saving surface mount package. The wide input voltage range of 12 to 50 VDC accepts the varying voltages of military, aerospace, or space applications. Single output converters feature outputs of 5, 12, or 15 volts while dual output models feature outputs of  $\pm 5$ ,  $\pm 12$ , or  $\pm 15$  volts. Transient protection of 80 volts for up to 120 milliseconds exceeds the requirements of MIL-STD-704A for the 5 and 12 volt single and dual models. The 15 volt single and dual converters will withstand transients of up to 70 volts for up to 120 milliseconds.

### CONVERTER DESIGN

MGH Series DC/DC converters incorporate a continuous flyback topology with a constant switching frequency of approximately 370 kHz. Output voltage regulation is accomplished on the primary side using current-mode pulse width modulation (PWM). Regulation is affected by the output load; refer to the specifications tables for more information.

For dual output models, up to 80% of the total load may be on one output providing the other output carries a minimum of 20% of the total load. The dual models can be used at double the output voltage by connecting the load between positive and negative outputs, leaving the common unconnected. As an example the MGH2805D (5 volt dual output) can be used as a 10 VDC output.

### INHIBIT FUNCTION

When an open collector TTL logic low is applied to the inhibit terminal, pin 18, the converter shuts down and lowers the output voltage to near zero and input current to as low 2.3 mA. Leaving the terminal open or applying an open collector TTL logic high will enable the converter.

### PROTECTION FEATURES

Undervoltage lockout prevents the MGH Series converters from operating below approximately 8 VDC input voltage to keep system current levels smooth, especially during initialization or re-start operations. All models include a soft-start function to prevent large current draw and minimize overshoot. The MGH Series of converters also provide short circuit protection by limiting the current to approximately 125% of full load.

### MIL-STD-461

Use Interpoint's FMGA-461 EMI filter to pass the CE03 requirements of MIL-STD-461C.

### SURFACE MOUNT PACKAGE

MGH DC/DC converters can be surface mounted with pick-and-place equipment or manually. It is recommended that the case be attached with flexible epoxy adhesive or silicone which is thermally conductive ( $>1$  watt /meter/ $^{\circ}$ K).

Internal components are soldered with SN96 (melting temperature  $221^{\circ}$ C) to prevent damage during reflow. Maximum reflow temperature for surface mounting the MGH converter is  $220^{\circ}$ C for a maximum of 30 seconds. SN60, 62, or 63 are the recommended types of solder. Hand soldering should not exceed  $300^{\circ}$ C for 10 seconds per pin.

The hermetically sealed metal cases are available in two different lead configurations. See case B for dimensions and options.

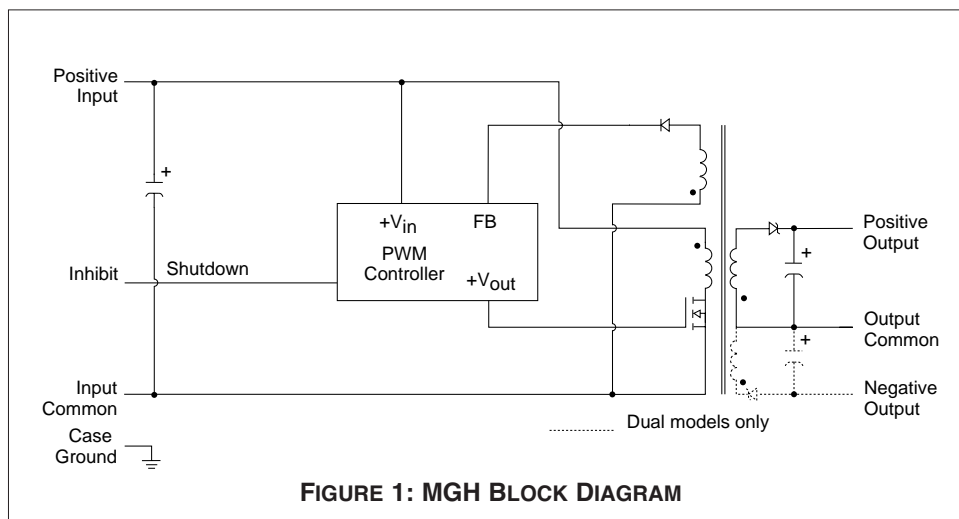

FIGURE 1: MGH BLOCK DIAGRAM

# MCH/MGH Single and Dual DC/DC Converters

## 28 VOLT INPUT – 1.5 WATT

### OPERATING CONDITIONS AND CHARACTERISTICS

#### Input Voltage Range

- 12 to 50 VDC continuous
- 80 V for 120 msec transient  
(70 V for 15 V single and dual models)

#### Output Power

- 1.5 W

#### Capacitive Load

- 200  $\mu$ F single output models
- 100  $\mu$ F each output, dual output models

#### Lead Soldering Temperature

- Reflow 220°C 30 sec. max  
SN60, 62 or 63 recommended solder
- Hand solder 300°C 10 sec. max per lead

#### Storage Temperature Range (Case)

- -65°C to +150°C

#### Case Operating Temperature (Tc)

- -55°C to +125°C full power
- -55°C to +135°C absolute

#### Derating Output Power/Current (Tc)

- Linearly from 100% at 125°C to 0% at 135°C

#### Output Voltage Temperature Coefficient

- 100 ppm/°C typical

#### Input to Output Capacitance

- 100 to 170 pF typical

#### Current Limit

- 125% of full load typical

#### Isolation

- 100 megohm minimum at 500 V

#### Audio Rejection

- 40 dB typical

#### Conversion Frequency (kHz)

- 25°C  
300 min, 370 typ, 450 max
- -55°C to +125°C  
270 min, 370 typ, 470 max

#### Inhibit Pin Voltage (unit enabled)

- 7 to 12 V

#### Undervoltage Lockout

- 8 V input typical

### INHIBIT

#### Inhibit – TTL Open Collector

- Logic low (output disabled)  
Logic low voltage  $\leq 0.8$  V  
Inhibit pin current 1 mA max
- Referenced to input common
- Logic high (output enabled) open collector

### MECHANICAL AND ENVIRONMENTAL

#### Size (maximum)

MCH models 0.980 x 0.805 x 0.270 inches (24.89 x 20.45 x 6.86 mm)  
See case A2 for dimensions.

MGH models 1.010 x 0.880 x 0.250 inches (25.65 x 22.35 x 6.35 mm)

Shown on page one with "gull wing" lead option, also available with straight leads. See case B for dimensions and options.

#### Weight (maximum)

12 grams typical

#### Screening

Standard, ES, or 883 (Class H, QML). See "883, Class H, QML Products – Element Evaluation" and "883, Class H, QML Products – Environmental Screening" for more information.

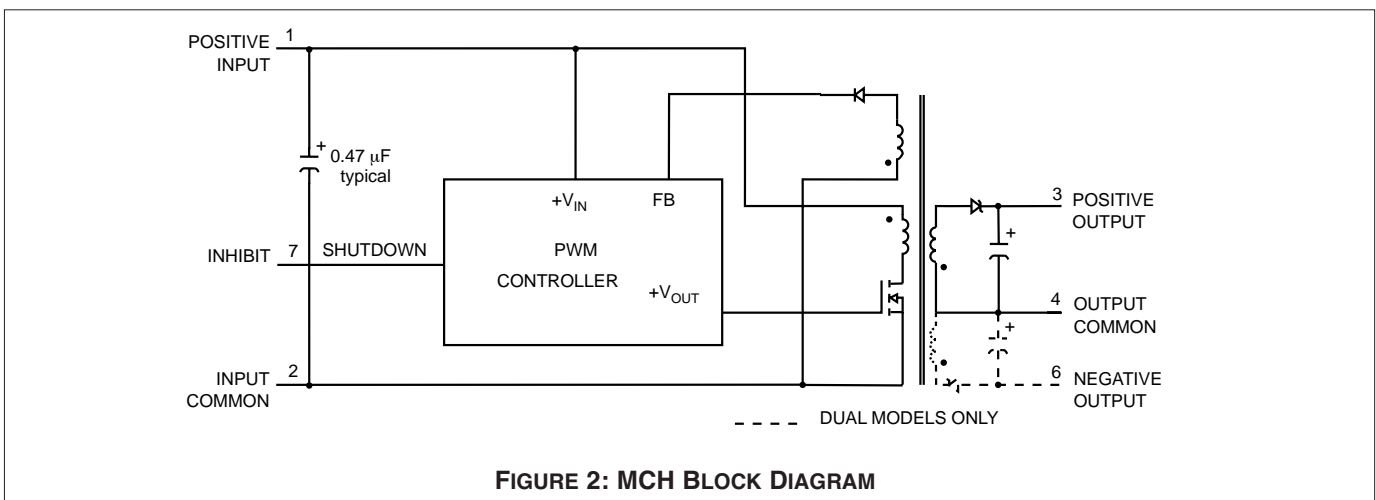

FIGURE 2: MCH BLOCK DIAGRAM

# MCH/MGH Single and Dual DC/DC Converters

## 28 VOLT INPUT – 1.5 WATT

### PIN OUT MCH MODELS

Pin	Single Output	Dual Output
1	Positive Input	Positive Input
2	Input Common	Input Common
3	Positive Output	Positive Output
4	Output Common	Output Common
5	Case Ground	Case Ground
6	No connection	Negative Output
7	Inhibit	Inhibit

Squared corner and dot on top of cover indicate pin one.

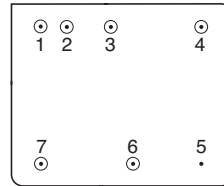

See case A2 for dimensions.

**FIGURE 3: MCH PIN OUT**

### PINS NOT IN USE

Inhibit (INH1, INH2)	Leave unconnected
Pin 2, 12, 15, 16, 17 (pins with no connection)	Ground to input common

### PIN OUT MGH MODELS

Pin	Single Output	Dual Output
1	Positive Input	Positive Input
2	No connection	No connection
3	Input Common	Input Common
4, 5	Positive Output	Positive Output
6, 7	Case Ground	Case Ground
8, 9	Output Common	Output Common
10, 11	Case Ground	Case Ground
12	No connection	No connection
13, 14	No connection	Negative Output
15, 16, 17	No connection	No connection
18	Inhibit	Inhibit

To meet specified performance, all pins must be connected except "No Connection" pins.

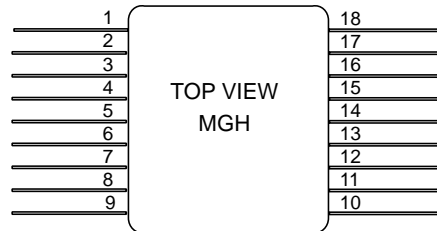

Differently colored glass bead around pin one or dimple in header (bottom or side of case) indicates pin one. Cover marking is oriented with pin one at the upper right corner.

See case B for dimensions and "gull-wing" option.

**FIGURE 4: MGH PIN OUT**

# MCH/MGH Single and Dual DC/DC Converters

## 28 VOLT INPUT – 1.5 WATT

**MCH Model Selection Table (see next page for MGH options)**

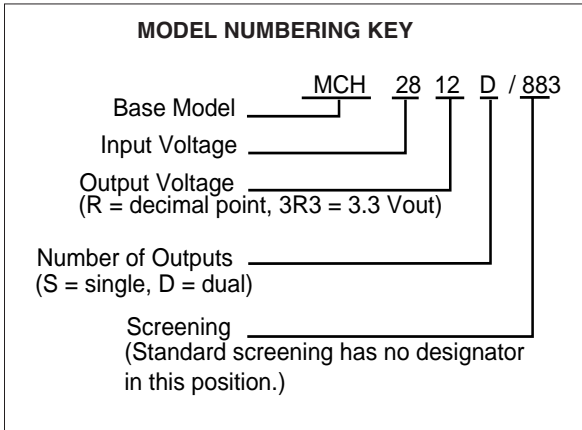

**SMD NUMBERS**

STANDARD MICROCIRCUIT DRAWING (SMD)	MCH SERIES SIMILAR PART
5962-9569601HXC	MCH2805S/883
5962-9569701HXC	MCH2812S/883
5962-9569801HXC	MCH2815S/883
5962-9570201HXC	MCH2805D/883
5962-9570301HXC	MCH2812D/883
5962-9570401HXC	MCH2815D/883

For exact specifications for an SMD product, refer to the SMD drawing. SMDs can be downloaded from:  
<http://www.dscc.dla.mil/programs/smcr>

**Model Selection**

<b>MCH28</b>	_____	_____	_____	_____
<i>Base model</i>	<i>Vout value</i>	<i>number of outputs</i>	<i>case option</i>	<i>screening</i>
Choose one from each of the following rows				
<b>Vout value</b>	for singles: 5, 5R2, 12, 15		duals: 5, 12, 15	
<i>"R" = decimal point, 3R3 = 3.3 VDC</i>				
<b>Number of outputs</b>	S (single) or D (dual)			
<b>Case option</b>	standard (case A2, leave blank)			
<b>Screening</b>	standard screening, leave blank		/ES (ES screening), /883 (Class H, QML)	

# MCH/MGH Single and Dual DC/DC Converters

## 28 VOLT INPUT – 1.5 WATT

**MGH Model Selection Table (see previous page for MCH options)**

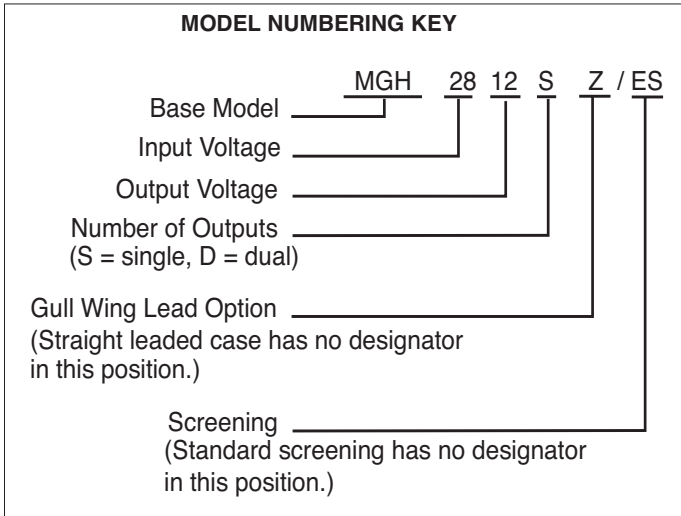

**SMD NUMBERS**

STANDARD MICROCIRCUIT DRAWING (SMD)	MCH/MGH SERIES SIMILAR PART
5962-9569601HYC	MGH2805S/883
5962-9569701HYC	MGH2812S/883
5962-9569801HYC	MGH2815S/883
5962-9570201HYC	MGH2805D/883
5962-9570301HYC	MGH2812D/883
5962-9570401HYC	MGH2815D/883

For exact specifications for an SMD product, refer to the SMD drawing. For the gull wing lead option, replace the Y in the SMD number (HYC) with a Z (HZC). SMDs can be downloaded from <http://www.dscccols.com/programs/smc>

**Model Selection**

<u>MGH28</u> <i>Base model</i>	<u>        </u> <i>Vout value</i>	<u>        </u> <i>number of outputs</i>	<u>        </u> <i>screening</i>
Choose one from each of the following rows			
<b>Vout value</b>	singles: 5, 12, 15	duals: 5, 12, 15	
<i>"R" = decimal point, 3R3 = 3.3 VDC</i>			
<b>Number of outputs</b>	S (single) or D (dual)		
<b>Screening</b>	standard screening, leave blank		/ES (ES screening), /883 (Class H, QML)

# MCH/MGH Single and Dual DC/DC Converters

## 28 VOLT INPUT – 1.5 WATT

Electrical Characteristics: 25°C Tc, 28 VDC Vin, 100% load, unless otherwise specified.

MCH SINGLE OUTPUT MODELS		MCH2805S			MCH2812S			MCH2815S			UNITS
PARAMETER	CONDITIONS	MIN	TYP	MAX	MIN	TYP	MAX	MIN	TYP	MAX	
OUTPUT VOLTAGE <sup>2</sup>	Tc = 25°C	4.95	5	5.05	11.88	12	12.12	14.85	15	15.15	VDC
	Tc = -55°C TO +125°C	4.80	5	5.20	11.52	12	12.48	14.40	15	15.60	
OUTPUT CURRENT	V <sub>IN</sub> = 12 to 50 VDC	—	—	300	—	—	125	—	—	100	mA
OUTPUT POWER	V <sub>IN</sub> = 12 TO 50 VDC	0	—	1.5	0	—	1.5	0	—	1.5	W
OUTPUT RIPPLE VOLTAGE	10 kHz - 2 MHz	—	45	150	—	50	200	—	35	150	mV p-p
	Tc = -55°C TO +125°C	—	65	300	—	70	300	—	50	250	
LINE REGULATION	V <sub>IN</sub> = 12 TO 50 VDC	—	35	120	—	60	250	—	70	350	mV
	Tc = -55°C TO +125°C	—	40	120	—	70	250	—	80	350	
LOAD REGULATION	10% TO FULL LOAD	—	350	800	—	600	1400	—	700	1600	mV
	Tc = -55°C TO +125°C	—	380	800	—	640	1400	—	760	1600	
	50% TO FULL <sup>1</sup>	—	100	200	—	145	300	—	165	350	
	Tc = -55°C TO +125°C	—	115	300	—	160	400	—	185	450	
INPUT VOLTAGE	CONTINUOUS	12	28	50	12	28	50	12	28	50	VDC
NO LOAD TO FULL	TRANSIENT <sup>1</sup> 120 ms	0	—	80	0	—	80	0	—	70	V
INPUT CURRENT	NO LOAD	—	5.5	11	—	6.0	12	—	6.0	12	mA
	Tc = -55°C TO +125°C	—	6.0	11	—	6.5	12	—	6.5	12	
	INHIBITED	—	2.3	3.5	—	2.3	3.5	—	2.3	3.5	
	Tc = -55°C TO +125°C	—	2.4	3.5	—	2.4	3.5	—	2.4	3.5	
INPUT RIPPLE CURRENT <sup>3</sup>	10k Hz - 10 MHz	—	100	200	—	100	200	—	100	200	mA p-p
	Tc = -55°C TO +125°C	—	130	250	—	150	250	—	150	250	
EFFICIENCY	Tc = 25°C	72	77	—	74	79	—	74	79	—	%
	Tc = -55°C TO +125°C	69	75	—	72	77	—	72	77	—	
LOAD FAULT <sup>4,5</sup>	POWER DISSIPATION	—	1.3	2.0	—	2.0	3.2	—	2.3	3.7	W
	Tc = -55°C TO +125°C	—	1.4	2.3	—	2.2	3.5	—	2.5	4.0	
	RECOVERY <sup>1</sup>	—	3.0	15	—	3.5	20	—	4.0	20	
Tc = -55°C TO +125°C	—	3.5	15	—	3.5	20	—	4.0	20		
STEP LOAD RESPONSE <sup>6</sup>	50 %-100%- 50% LOAD TRANSIENT	-500	185	500	-700	350	700	-700	350	700	mV pk
	Tc = -55°C TO +125°C	-500	185	500	-800	380	800	-800	380	800	
	RECOVERY	—	125	500	—	130	500	—	140	600	
Tc = -55°C TO +125°C	—	125	600	—	130	600	—	180	750		
STEP LINE RESPONSE <sup>6</sup>	12 TO 50 TO 12 V <sub>IN</sub> TRANSIENT <sup>1</sup>	-500	170	500	-1000	400	1000	-850	400	850	mV pk
	Tc = -55°C TO +125°C	-500	180	500	-1000	400	1000	-850	450	850	
	RECOVERY <sup>1</sup>	—	0.75	4.0	—	0.6	3.0	—	0.47	2.5	
Tc = -55°C TO +125°C	—	0.75	4.0	—	0.6	3.0	—	0.5	2.5		
START-UP	DELAY	—	7	40	—	7	40	—	7	40	ms
	Tc = -55°C TO +125°C	—	10	40	—	10	40	—	10	40	
	OVERSHOOT <sup>1</sup>	—	0	150	—	0	350	—	0	450	
Tc = -55°C TO +125°C	—	0	150	—	0	350	—	0	450		
CAPACITIVE LOAD <sup>1</sup>											

Notes:

1. Guaranteed by design, not tested.

2. Specified at 50% total P<sub>out</sub>.

3. Lin = 2 μH.

4. Maximum duration of short circuit: 25°C— 90 seconds, 125°C – 30 seconds.

5. Load fault is a short circuit (<50 mohms). Recovery is into resistive full load.

6. Transition ≥ 10 μs. Recovery = time to settle to within 1% of Vout final value.

7. Max. spec indicates 80% of the converter's total power, available from either output.

# MCH/MGH Single and Dual DC/DC Converters

## 28 VOLT INPUT – 1.5 WATT

Electrical Characteristics: 25°C T<sub>c</sub>, 28 VDC V<sub>in</sub>, 100% load, unless otherwise specified.

MGH SINGLE OUTPUT MODELS		MGH2805S			MGH2812S			MGH2815S			UNITS
PARAMETER	CONDITIONS	MIN	TYP	MAX	MIN	TYP	MAX	MIN	TYP	MAX	
OUTPUT VOLTAGE <sup>1</sup>	T <sub>c</sub> = 25°C	4.95	5	5.05	11.88	12	12.12	14.85	15	15.15	VDC
	T <sub>c</sub> = -55°C TO +125°C	4.80	5	5.20	11.52	12	12.48	14.40	15	15.60	
OUTPUT CURRENT	V <sub>IN</sub> = 12 to 50 VDC	0	—	300	0	—	125	0	—	100	mA
OUTPUT POWER	V <sub>IN</sub> = 12 to 50 VDC	0	—	1.5	0	—	1.5	0	—	1.5	W
OUTPUT RIPPLE VOLTAGE	10 kHz - 2 MHz	—	45	150	—	50	200	—	35	150	mV p-p
	T <sub>c</sub> = -55°C TO +125°C	—	65	300	—	70	300	—	50	250	
LINE REGULATION	V <sub>IN</sub> = 12 to 50 VDC	—	35	100	—	60	200	—	70	300	mV
	T <sub>c</sub> = -55°C TO +125°C	—	40	120	—	70	250	—	80	350	
LOAD REGULATION	10% TO FULL LOAD	—	350	700	—	600	1300	—	700	1500	mV
	T <sub>c</sub> = -55°C TO +125°C	—	380	800	—	640	1400	—	760	1600	
	50% TO FULL LOAD	—	100	200	—	145	300	—	165	350	
	T <sub>c</sub> = -55°C TO +125°C	—	115	300	—	160	400	—	185	450	
INPUT VOLTAGE NO LOAD TO FULL	CONTINUOUS	12	28	50	12	28	50	12	28	50	VDC
	TRANSIENT 120 ms	0	—	80	0	—	80	0	—	70	V
INPUT CURRENT	NO LOAD	—	5.5	10	—	6.0	10	—	6.0	11	mA
	T <sub>c</sub> = -55°C TO +125°C	—	6.0	11	—	6.5	12	—	6.5	12	
	FULL LOAD	—	70	74	—	68	72	—	68	72	
	T <sub>c</sub> = -55°C TO +125°C	—	73	78	—	70	74	—	70	74	
INPUT RIPPLE CURRENT <sup>2</sup>	10k Hz - 10 MHz	—	100	200	—	100	200	—	100	200	mA p-p
	T <sub>c</sub> = -55°C TO +125°C	—	130	250	—	150	250	—	150	250	
EFFICIENCY	T <sub>c</sub> = 25°C	72	77	—	74	79	—	74	79	—	%
	T <sub>c</sub> = -55°C TO +125°C	69	75	—	72	77	—	72	77	—	
LOAD FAULT <sup>3, 4</sup>	POWER DISSIPATION	—	1.3	2.0	—	2.0	3.2	—	2.3	3.7	W
	T <sub>c</sub> = -55°C TO +125°C	—	1.4	2.3	—	2.2	3.5	—	2.5	4.0	
	RECOVERY	—	3.0	12	—	3.5	15	—	4.0	18	ms
	T <sub>c</sub> = -55°C TO +125°C	—	3.5	15	—	3.5	20	—	4.0	20	
STEP LOAD RESPONSE <sup>5</sup>	TRANSIENT	-400	185	400	-700	350	700	-700	350	700	mV pk
	T <sub>c</sub> = -55°C TO +125°C	-500	185	500	-800	380	800	-800	380	800	
50 %–100%– 50%	RECOVERY	—	125	500	—	130	500	—	140	600	μs
	T <sub>c</sub> = -55°C TO +125°C	—	125	600	—	130	600	—	180	750	
STEP LINE RESPONSE <sup>5</sup>	TRANSIENT	-400	170	400	-900	400	900	-750	400	750	mV pk
	T <sub>c</sub> = -55°C TO +125°C	-500	180	500	-1000	400	1000	-850	450	850	
12 TO 50 TO 12 V <sub>IN</sub>	RECOVERY	—	0.75	3.0	—	0.6	2.5	—	0.47	2.0	ms
	T <sub>c</sub> = -55°C TO +125°C	—	0.75	4.0	—	0.6	3.0	—	0.5	2.5	
START-UP 0 TO 28 VDC	DELAY	—	7	20	—	7	20	—	7	20	ms
	T <sub>c</sub> = -55°C TO +125°C	—	10	40	—	10	40	—	10	40	ms
	OVERSHOOT	—	0	100	—	0	250	—	0	300	mV pk
T <sub>c</sub> = -55°C TO +1 25°C	—	0	150	—	0	350	—	0	450		

### Notes

- Specified at 50% of full load.
- Lin = 2 μH
- Max. duration of short circuit: 25°C– 90 seconds; 125°C – 30 seconds.
- Load fault is a short circuit (<50 mohms). Recovery into resistive full load.
- Input step transition ≥ 10 μs. Recovery is time to settle to within 1% of V<sub>out</sub> final value.



# MCH/MGH Single and Dual DC/DC Converters

## 28 VOLT INPUT – 1.5 WATT

Electrical Characteristics: 25°C Tc, 28 VDC Vin, 100% load, unless otherwise specified.

MCH DUAL OUTPUT MODELS		MCH2805D			MCH2812D			MCH2815D			UNITS
PARAMETER	CONDITIONS	MIN	TYP	MAX	MIN	TYP	MAX	MIN	TYP	MAX	
OUTPUT VOLTAGE <sup>2</sup>	Tc = 25°C Tc = -55°C TO +125°C	±4.95 ±4.80	±5 ±5	±5.05 ±5.20	±11.88 ±11.52	±12 ±12	±12.12 ±12.48	±14.85 ±14.40	±15 ±15	±15.15 ±15.60	VDC
OUTPUT CURRENT <sup>7</sup>	V <sub>IN</sub> = 12 TO 50 VDC	0	±150	240	0	±62.5	100	0	±50	80	mA
OUTPUT POWER	V <sub>IN</sub> = 12 TO 50 VDC	0	—	1.5	0	—	1.5	0	—	1.5	W
OUTPUT RIPPLE VOLTAGE	10 kHz - 2 MHz Tc = -55°C TO +125°C	—	35	150	—	35	150	—	30	150	mV p-p
+V <sub>OUT</sub>		—	50	250	—	40	250	—	35	250	
-V <sub>OUT</sub>	10 kHz - 2 MHz Tc = -55°C TO +125°C	—	35	150	—	35	150	—	30	150	
LINE REGULATION <sup>8</sup>	V <sub>IN</sub> = 12 TO 50 VDC Tc = -55°C TO +125°C	—	10	50	—	100	300	—	165	500	mV
LOAD REGULATION <sup>9</sup>	10% TO FULL -55°C TO +125°C	—	300	600	—	550	1100	—	600	1300	mV
±V <sub>OUT</sub>	50% TO FULL <sup>1</sup> -55°C TO +125°C	—	80	200	—	115	250	—	125	300	
		—	100	300	—	130	350	—	135	400	
INPUT VOLTAGE	CONTINUOUS	12	28	50	12	28	50	12	28	50	VDC
NO LOAD TO FULL	TRANSIENT <sup>1</sup> 120 ms	0	—	80	0	—	80	0	—	70	V
INPUT CURRENT	NO LOAD Tc = -55°C TO +125°C	—	5.0	10	—	7.5	13	—	7.5	13	uF
	INHIBITED Tc = -55°C TO +125°C	—	2.3	3.2	—	2.3	3.2	—	2.3	3.2	
		—	2.4	3.5	—	2.4	3.5	—	2.4	3.5	
INPUT RIPPLE <sup>3</sup>	10 kHz - 10 MHz Tc = -55°C TO +125°C	—	100	200	—	115	200	—	90	200	mA p-p
CURRENT		—	130	250	—	150	250	—	120	250	
EFFICIENCY	Tc = 25°C Tc = -55°C TO +125°C	73 70	77 75	—	73 70	77 75	—	72 69	76 74	—	%
LOAD FAULT <sup>4,5</sup>	POWER DISSIPATION Tc = -55°C TO +125°C	—	1.4	2.2	—	2.5	3.8	—	2.7	4.1	W
	RECOVERY <sup>1</sup> Tc = -55°C TO +125°C	—	3.7	15	—	3.2	15	—	4.0	15	ms
		—	3.8	20	—	3.2	20	—	4.0	20	
STEP LOAD RESPONSE <sup>6</sup> ± V <sub>OUT</sub>	50 %–100%– 50% LOAD TRANSIENT Tc = -55°C TO +125°C	-300 -400	130 140	300 400	-600 -700	250 260	600 700	-600 -700	250 270	600 700	mV pk
	RECOVERY -55°C TO +125°C	—	100	400	—	165	700	—	50	200	μs
		—	100	500	—	165	800	—	50	300	
STEP LINE RESPONSE <sup>6</sup> ± V <sub>OUT</sub>	12 TO 50 TO 12 V <sub>IN</sub> TRANSIENT <sup>1</sup> Tc = -55°C TO +125°C	-250 -300	125 130	250 300	-500 -600	240 250	500 600	-500 -600	220 230	500 600	mV pk
	RECOVERY <sup>1</sup> Tc = -55°C TO +125°C	—	0.6	2.5	—	0.9	3.0	—	0.6	3.0	ms
		—	0.6	3.0	—	0.9	4.0	—	0.7	4.0	
START-UP	DELAY Tc = -55°C TO +125°C	—	8	25	—	8	25	—	8	25	ms
0 TO 28 VDC, ± V <sub>OUT</sub>		—	10	45	—	10	45	—	10	45	
	OVERSHOOT <sup>1</sup> Tc = -55°C TO +125°C	—	0	100	—	0	250	—	0	750	mV pk
		—	0	150	—	0	350	—	0	900	
CAPACITIVE LOAD											uF

Notes:

1. Guaranteed by design, not tested.

2. Specified at 50% balanced load.

3. Lin = 2 μH.

4. Maximum duration of short circuit: 25°C— 90 seconds, 125°C – 30 seconds.

5. Load fault is a short circuit (<50 mohms). Recovery is into resistive full load, with one output shorted at a time.

6. Transition ≥ 10 μs. Recovery = time to settle to within 1% of Vout final value.

7. Max. spec indicates 80% of the converter's total power, available from either output.

8. Specification applies to both + and – Vout.

9. Although no minimum load is required, at no load the output voltage may increase up to 15%.

# MCH/MGH Single and Dual DC/DC Converters

## 28 VOLT INPUT – 1.5 WATT

Electrical Characteristics: 25°C Tc, 28 VDC Vin, 100% load, unless otherwise specified.

MGH DUAL OUTPUT MODELS		MGH2805D			MGH2812D			MGH2815D			UNITS
PARAMETER	CONDITIONS	MIN	TYP	MAX	MIN	TYP	MAX	MIN	TYP	MAX	
OUTPUT VOLTAGE <sup>1</sup>	Tc = 25°C Tc = -55°C TO +125°C	±4.95 ±4.80	±5 ±5	±5.05 ±5.20	±11.88 ±11.52	±12 ±12	±12.12 ±12.48	±14.85 ±14.40	±15 ±15	±15.15 ±15.60	VDC
OUTPUT CURRENT <sup>2</sup>	V <sub>IN</sub> = 12 to 50 VDC	0	±150	240	0	±62.5	100	0	±50	80	mA
OUTPUT POWER	V <sub>IN</sub> = 12 to 50 VDC	0	—	1.5	0	—	1.5	0	—	1.5	W
OUTPUT RIPPLE VOLTAGE +V <sub>OUT</sub> -V <sub>OUT</sub>	10 kHz - 2 MHz Tc = -55°C TO +125°C 10 kHz - 2 MHz Tc = -55°C TO +125°C	— —	35 50	150 250	— —	35 40	150 250	— —	30 35	150 250	mV p-p
LINE REGULATION <sup>3</sup>	V <sub>IN</sub> = 12 to 50 VDC Tc = -55°C TO +125°C	— —	10 20	50 100	— —	100 110	300 400	— —	165 180	500 650	V
LOAD REGULATION <sup>3, 4</sup>	10% TO FULL LOAD -55°C TO +125°C 50% TO FULL LOAD -55°C TO +125°C	— —	300 350	600 700	— —	550 570	1100 1200	— —	600 630	1300 1400	mV
CROSS REGULATION <sup>5</sup>	-V <sub>OUT</sub>	—	—	400	—	—	500	—	—	500	mV
INPUT VOLTAGE NO LOAD TO FULL	CONTINUOUS TRANSIENT 120 ms	12 0	28 —	50 80	12 0	28 —	50 80	12 0	28 —	50 70	VDC V
INPUT CURRENT	NO LOAD Tc = -55°C TO +125°C FULL LOAD Tc = -55°C TO +125°C INHIBITED Tc = -55°C TO +125°C	— — — —	5.0 6.0 69 72	10 12 73 77	— — — —	7.5 8.0 70 71	13 14 73 77	— — — —	7.5 8.0 71 72	13 14 74 78	mA
INPUT RIPPLE <sup>6</sup> CURRENT	10 kHz - 10 MHz Tc = -55°C TO +125°C	— —	100 130	200 250	— —	115 150	200 250	— —	90 120	200 250	mA p-p
EFFICIENCY	Tc = 25°C Tc = -55°C TO +125°C	73 70	77 75	— —	73 70	77 75	— —	72 69	76 74	— —	%
LOAD FAULT <sup>7,8</sup>	POWER DISSIPATION Tc = -55°C TO +125°C RECOVERY Tc = -55°C TO +125°C	— —	1.4 1.6	2.2 2.5	— —	2.5 2.7	3.8 4.2	— —	2.7 3.0	4.1 4.5	W ms
STEP LOAD RESPONSE <sup>9</sup>	TRANSIENT Tc = -55°C TO +125°C RECOVERY -55°C TO +125°C	-300 -400	130 140	300 400	-600 -700	250 260	600 700	-600 -700	250 270	600 700	mV pk μs
STEP LINE RESPONSE <sup>19</sup>	TRANSIENT Tc = -55°C TO +125°C RECOVERY Tc = -55°C TO +125°C	-250 -300	125 130	250 300	-500 -600	240 250	500 600	-500 -600	220 230	500 600	mV pk ms
START-UP 0 TO 28 VDC, ± V <sub>out</sub>	DELAY Tc = -55°C TO +125°C OVERSHOOT Tc = -55°C TO +125°C	— —	8 10	25 45	— —	8 10	25 45	— —	8 10	25 45	ms mV pk

Notes:

- Specified at 50% load.
- Max. spec indicates 80% of the converter's total available power. This 80% is available from either output.
- Specification applies to both + and -V<sub>out</sub>.
- Although no minimum load is required, at no load the output voltage may increase up to 15%.
- Cross regulation is specified as the effect on -V<sub>out</sub> for the following percent

ages of total output power: +Po = 20% and  
-Po = 80% to +Po=80% and -Po=20%

6. Lin = 2 μH.

7. Max. duration of short circuit: 25°C – 90 seconds; 125°C – 30 seconds.

8. Load fault is a short circuit (<50 mohms). Recovery into resistive full load.

9. Input step transition ≥ 10 μs. Recovery is time to settle to within 1% of V<sub>out</sub> final value.

# MCH/MGH Single and Dual DC/DC Converters

## 28 VOLT INPUT – 1.5 WATT

Typical Performance Curves: 25°C Tc, 28 VDC Vin, 100% load, unless otherwise specified.

### MCH SINGLE AND DUAL OUTPUT MODELS

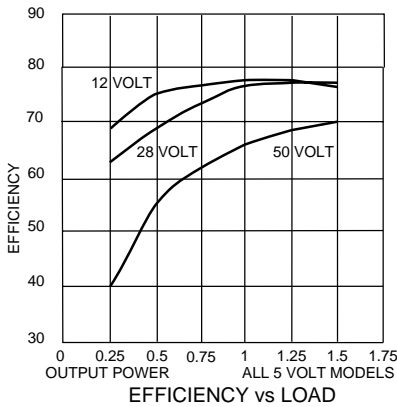

**FIGURE 5**

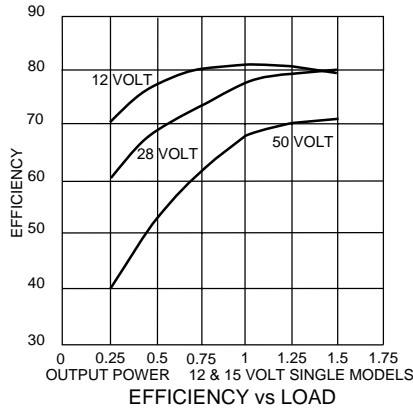

**FIGURE 6**

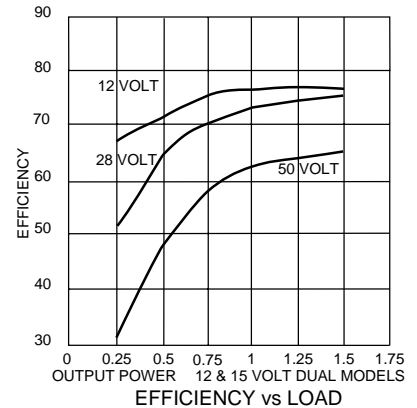

**FIGURE 7**

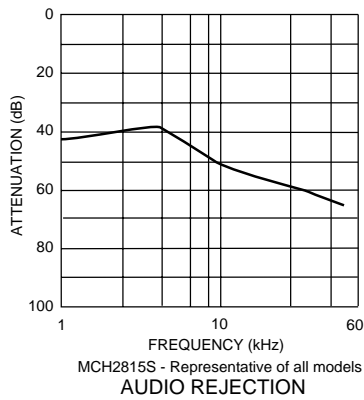

**FIGURE 8**

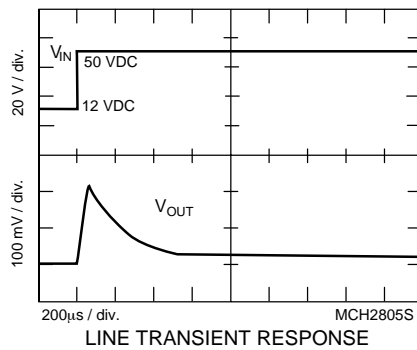

**FIGURE 9**

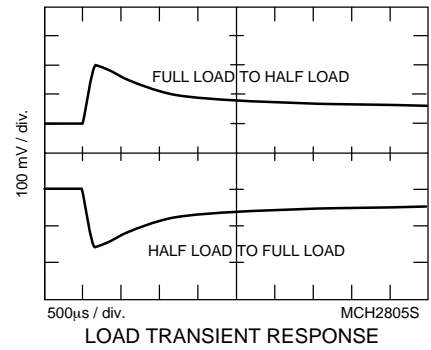

**FIGURE 10**

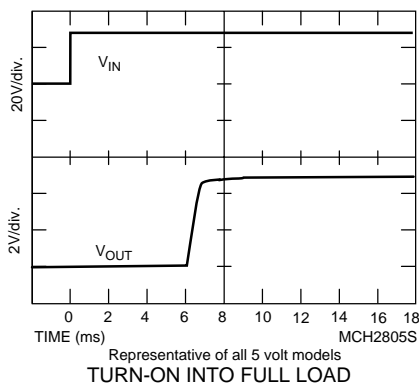

**FIGURE 11**

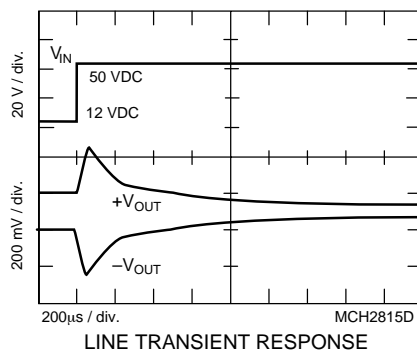

**FIGURE 12**

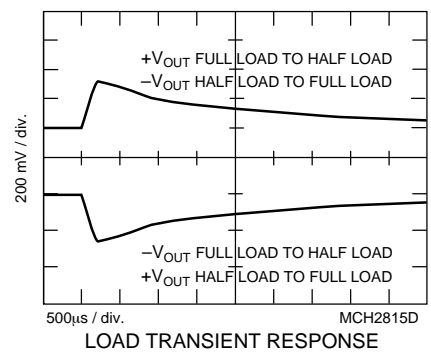

**FIGURE 13**

# MCH/MGH Single and Dual DC/DC Converters

## 28 VOLT INPUT – 1.5 WATT

Typical Performance Curves: 25°C Tc, 28 VDC Vin, 100% load, unless otherwise specified.

### MCH SINGLE AND DUAL OUTPUT MODELS (CONT.)

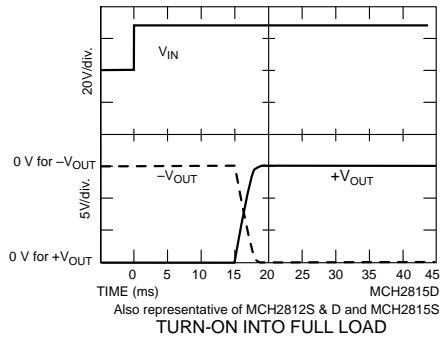

**FIGURE 14**

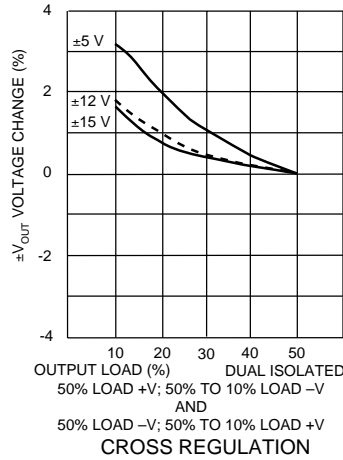

**FIGURE 15**

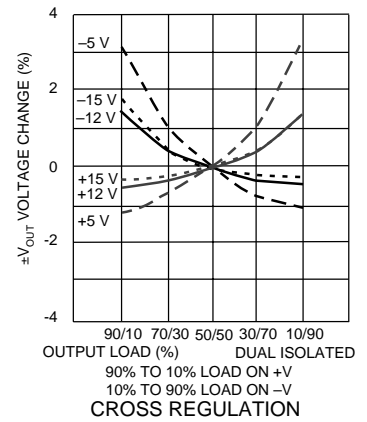

**FIGURE 16**

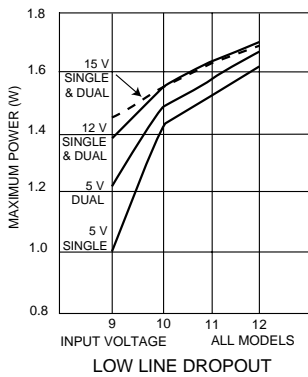

**FIGURE 17**

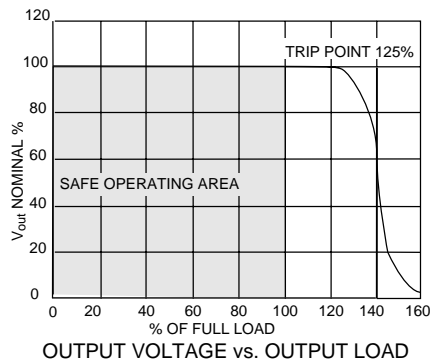

**FIGURE 18**

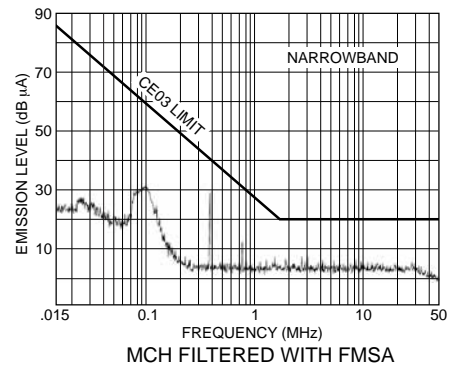

**FIGURE 19**

# MCH/MGH Single and Dual DC/DC Converters

## 28 VOLT INPUT – 1.5 WATT

**Typical Performance Curves: 25°C Tc, 28 VDC Vin, 100% load, unless otherwise specified.**

### MGH SINGLE AND DUAL OUTPUT MODELS

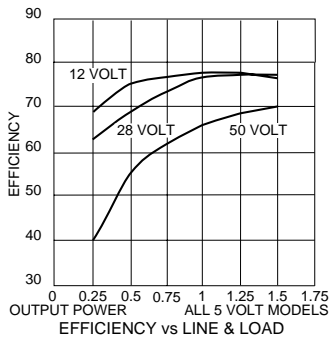

**FIGURE 20**

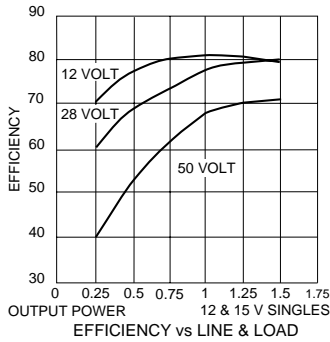

**FIGURE 21**

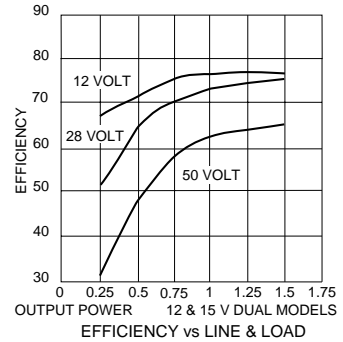

**FIGURE 22**

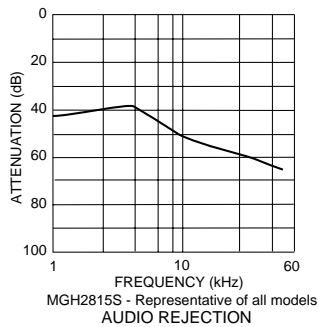

**FIGURE 23**

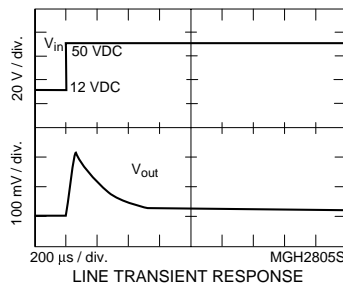

**FIGURE 24**

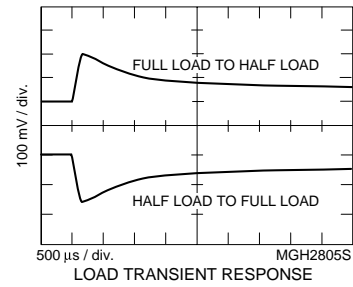

**FIGURE 25**

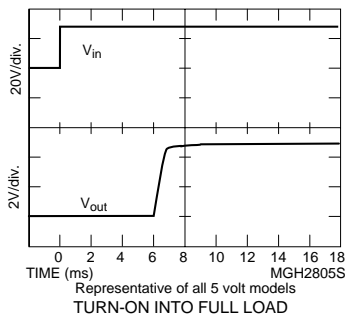

**FIGURE 26**

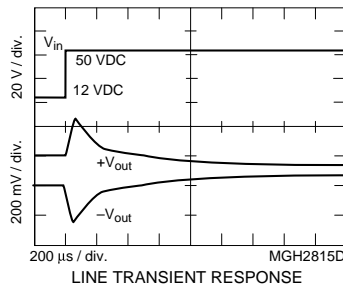

**FIGURE 27**

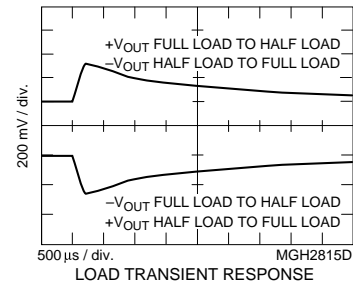

**FIGURE 28**

# MCH/MGH Single and Dual DC/DC Converters

## 28 VOLT INPUT – 1.5 WATT

Typical Performance Curves: 25°C Tc, 28 VDC Vin, 100% load, unless otherwise specified.

### MGH SINGLE AND DUAL OUTPUT MODELS (CONT.)

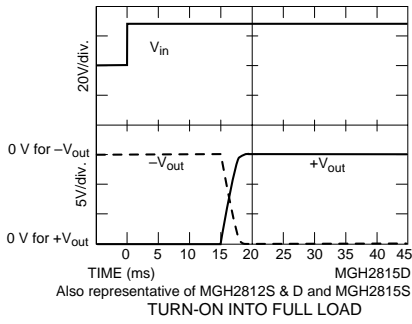

**FIGURE 29**

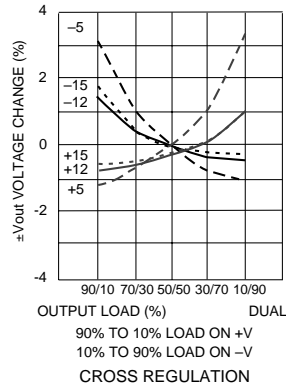

**FIGURE 30**

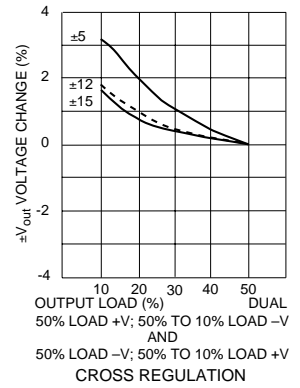

**FIGURE 31**

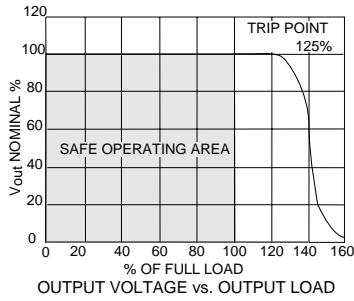
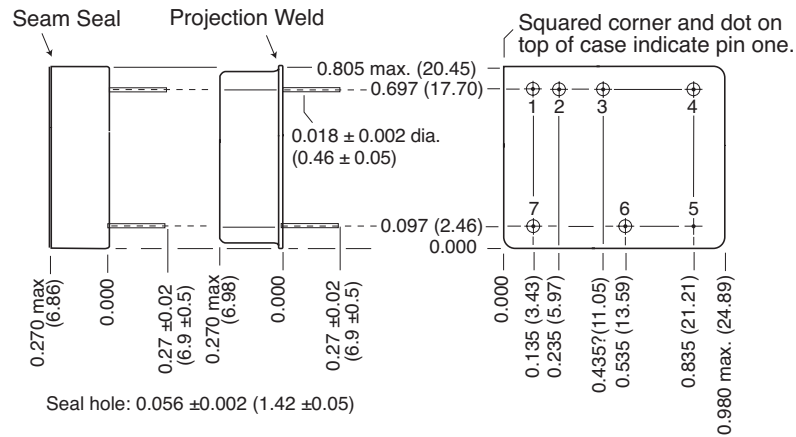

**FIGURE 32**

# MCH/MGH Single and Dual DC/DC Converter Cases

## 28 VOLT INPUT – 1.5 WATT

### BOTTOM VIEW CASE A2



#### Case dimensions in inches (mm)

Tolerance  $\pm 0.005$  (0.13) for three decimal places  
 $\pm 0.01$  (0.3) for two decimal places  
 unless otherwise specified

#### CAUTION

Heat from reflow or wave soldering may damage the device.  
 Solder pins individually with heat application not exceeding 300°C for 10 seconds per pin

#### Materials

Header Kovar/Nickel/Gold  
 Cover Kovar/Nickel  
 Pins Kovar/Nickel/Gold matched glass seal

Case A2, Rev C, 20060110

Please refer to the numerical dimensions for accuracy. All information is believed to be accurate, but no responsibility is assumed for errors or omissions. Interpoint reserves the right to make changes in products or specifications without notice.  
 Copyright © 1999-2006 Interpoint Corp. All rights reserved.

FIGURE 33: CASE A2

# MCH/MGH Single and Dual DC/DC Converter Cases

## 28 VOLT INPUT – 1.5 WATT

### TOP VIEW CASE B

Differently colored glass bead around pin one or dimple in header (bottom or side of case) indicates pin one.  
Cover marking is oriented with pin one at the upper right corner.

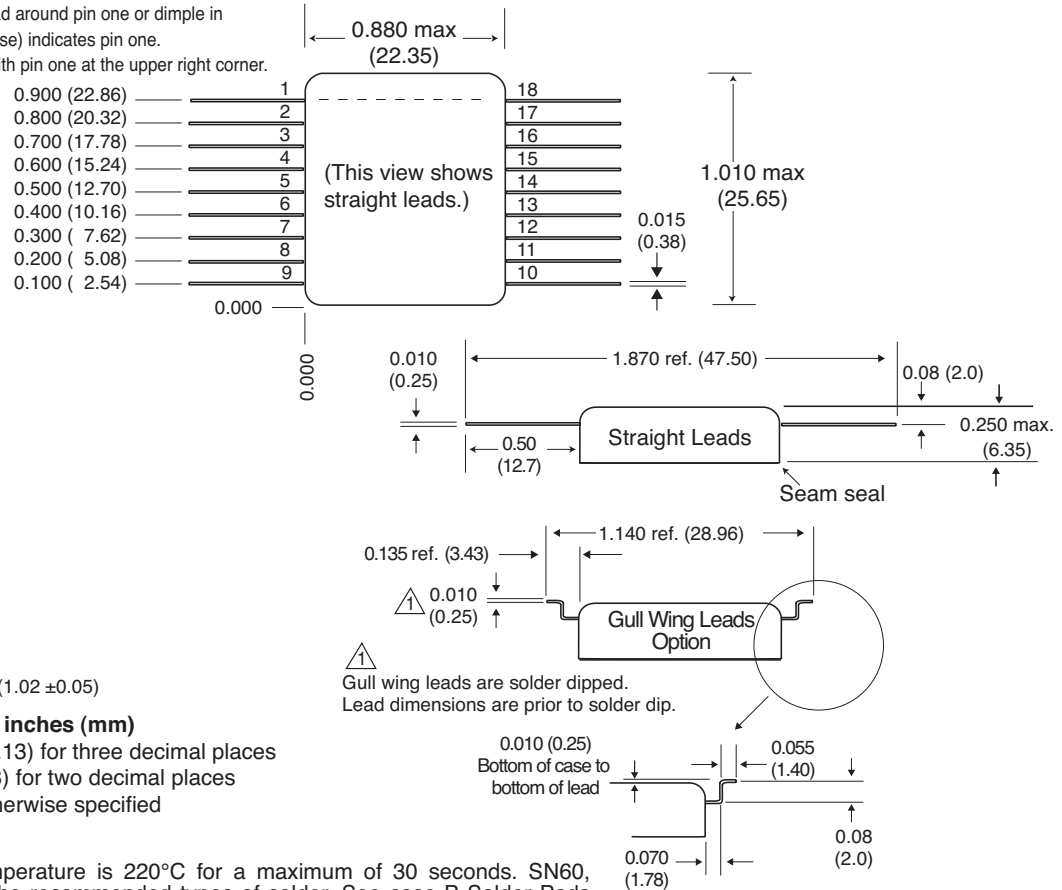

Seal hole:  $0.040 \pm 0.002$  (1.02  $\pm$  0.05)

#### Case dimensions in inches (mm)

Tolerance  $\pm 0.005$  (0.13) for three decimal places  
 $\pm 0.01$  (0.3) for two decimal places  
unless otherwise specified

#### CAUTION

Maximum reflow temperature is 220°C for a maximum of 30 seconds. SN60, SN62, or SN63 are the recommended types of solder. See case B Solder Pads for Solder Mask instructions.

Hand soldering should not exceed 300°C for 10 seconds per pin.

#### Materials

Header Kovar/Nickel/Gold  
Cover Kovar/Nickel  
Pins Kovar/Nickel/Gold matched glass seal

Case B, Rev C, November 9, 2005

Please refer to the numerical dimensions for accuracy. All information is believed to be accurate, but no responsibility is assumed for errors or omissions. Interpoint reserves the right to make changes in products or specifications without notice. Copyright © 1999-2006 Interpoint Corp. All rights reserved.

FIGURE 34: CASE B



# MCH/MGH Single and Dual DC/DC Converters

28 VOLT INPUT – 1.5 WATT

## 883, CLASS H, QML PRODUCTS – ELEMENT EVALUATION

ELEMENT EVALUATION  TEST PERFORMED (COMPONENT LEVEL)	STANDARD (NON-QML) <sup>1</sup>		CLASS H, QML	
	M/S <sup>2</sup>	P <sup>3</sup>	M/S <sup>2</sup>	P <sup>3</sup>
Element Electrical (probe)	yes	no	yes	yes
Element Visual	no	no	yes	yes
Internal Visual	no	no	yes	no
Final Electrical	no	no	yes	yes
Wire Bond Evaluation <sup>4</sup>	no	no	yes	yes
SLAM™/C-SAM: Input Capacitors only (Add'l test, not req. by H or K)	no	no	no	yes

**Definitions:**

Element Evaluation: Component testing/screening per MIL-STD-883 as determined by MIL-PRF-38534

SLAM™: Scanning Laser Acoustic Microscopy

C-SAM: C - Mode Scanning Acoustic Microscopy

**Notes:**

1. Non-QML products do not meet all of the requirements of MIL-PRF-38534
2. M/S = Active components (Microcircuit and Semiconductor Die)
3. P = Passive components
4. Not applicable to EMI filters that have no wire bonds

# MCH/MGH Single and Dual DC/DC Converters

28 VOLT INPUT – 1.5 WATT

## 883, CLASS H, QML PRODUCTS – ENVIRONMENTAL SCREENING

TEST	125°C STANDARD non-QML	125°C /ES non-QML	Class H /883 QML
Pre-cap Inspection Method 2017, 2032	yes	yes	yes
Temperature Cycle (10 times) Method 1010, Cond. C, -65°C to 150°C, ambient Method 1010, Cond. B, -55°C to 125°C, ambient	no no	no yes	yes no
Constant Acceleration Method 2001, 3000 g Method 2001, 500g	no no	no yes	yes no
Burn-In Method 1015, 160 hours at 125°C case, typical 96 hours at 125°C case, typical	no no	no yes	yes no
Final Electrical Test MIL-PRF-38534, Group A Subgroups 1 through 6: -55°C, +25°C, +125°C case Subgroups 1 and 4: +25°C case	no yes	no yes	yes no
Hermeticity Test Fine Leak, Method 1014, Cond. A Gross Leak, Method 1014, Cond. C Gross Leak, Dip (1 x 10 <sup>-3</sup> )	no no yes	yes yes no	yes yes no
Final Visual Inspection Method 2009	yes	yes	yes

Test methods are referenced to MIL-STD-883 as determined by MIL-PRF-38534.