

DATA SHEET

DD02-999, DD02-999LF: 650 MHz–3 GHz Directional Detector

Features

- Frequency coverage: 650 MHz to 3 GHz
- Low insertion loss: 0.2 dB typ. up to 2 GHz
- Directivity: 23 dB typ.
- Small outline SC-88 (6-Lead SC-70)
- Built-in temperature compensating diode
- Low cost for high-volume handset applications
- Available lead (Pb)-free and RoHS-compliant MSL-1 @ 260 °C per JEDEC J-STD-020

Description

The DD02-999 directional detector is designed to operate from 650 MHz to 3 GHz. It contains a high-directivity directional coupler, the coupled arm of which drives a GaAs Schottky detector diode. It also contains an identical GaAs Schottky diode used for temperature compensation. This part is packaged in the miniature SC-88 package. The DD02-999LF is packaged in the lead (Pb)-free SC-88 package and is fully compliant with current RoHS requirements.

The DD02-999 provides detection of the input signal amplitude only, by virtue of the directivity of the on-chip directional coupler. The sensitivity of the detector diode is improved through the application of an external 5 μ A (nominal) forward bias current produced by an external 1 V (nominal) voltage source. This bias current is also applied to the temperature compensation diode. Temperature compensation of the detected output voltage can be accomplished by subtracting the output voltage from the temperature compensation Schottky diode, which is thermally coupled to the detector Schottky diode via their common substrate, from the detected output voltage.

This part is rated to operate from -40 °C to 85 °C.

An evaluation board is available upon request.

NEW Skyworks offers lead (Pb)-free, RoHS (Restriction of Hazardous Substances)-compliant packaging.



Pin Out

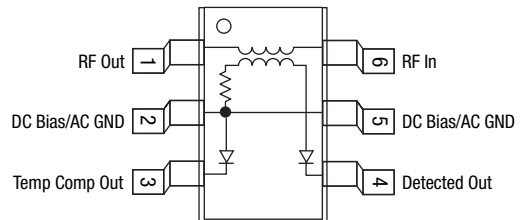

 **Innovation to Go™**
Now available for purchase online.

Electrical Specifications at 25 °C **$T_A = 25\text{ C}$, $Z_0 = 50\ \Omega$, $P_{IN} = 10\text{ dBm}$, $V_{BIAS} = 1\text{ V}$ at pins 2 and 5, $R_{LOAD} = 100\text{ k}\Omega$, unless otherwise noted**

Parameter	Frequency	Min.	Typ.	Max.	Unit
Detected output voltage @ 10 dBm	0.8–1.2 GHz	60	80	105	mV
	1.8–2.0 GHz	130	160	190	mV
Insertion loss	0.8–1.2 GHz		0.1	0.2	dB
	1.8–2.0 GHz		0.2	0.3	dB
Input return loss	0.8–1.2 GHz		30	22	dB
	1.8–2.0 GHz		25	20	dB
Output return loss	0.8–1.2 GHz		30	22	dB
	1.8–2.0 GHz		25	20	dB
Directivity	0.8–1.2 GHz	17	20		dB
	1.8–2.0 GHz	16	13		dB
Schottky noise voltage (1 MHz bandwidth)	RF power off		200		μV
Schottky diode DC voltage	RF power off		510		mV
DC offset voltage	RF power off	-5	0	5	mV
Video resistance	RF power off		7500		Ω

Conditions: 10 dBm input power, 1 V applied to Pin 2 and 5 (See test circuit).
All data was taken with $R_{LOAD} = 100\text{ k}\Omega$.

Detected output voltage is the difference between V_{REF} and V_{DET} . A digital voltmeter was used as a differential amplifier.

Typical Performance Data

$T_A = 25\text{ C}$, $Z_0 = 50\ \Omega$, unless otherwise noted

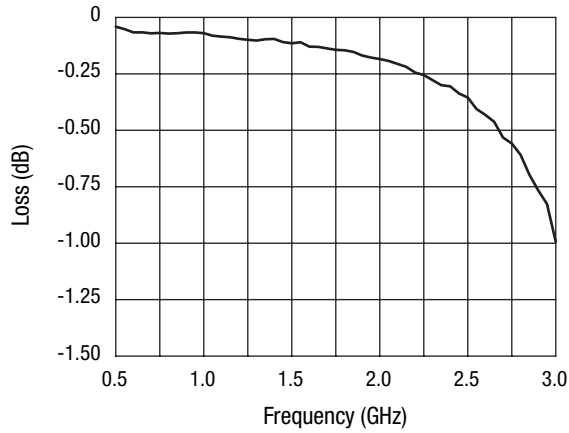

Insertion Loss vs. Frequency

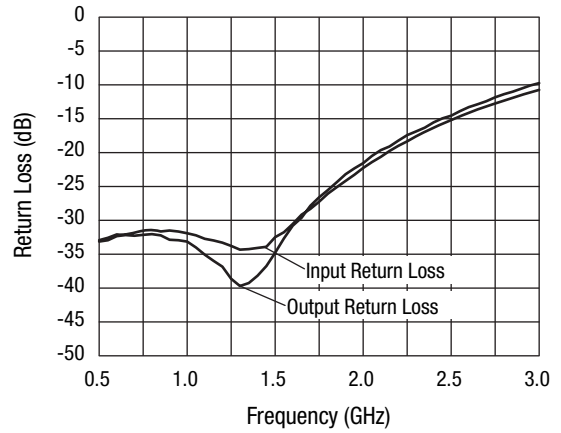

Return Loss vs. Frequency

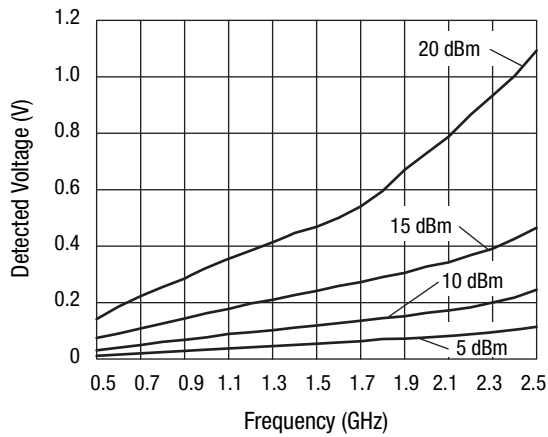

Differential Detected Voltage vs. Frequency and Power

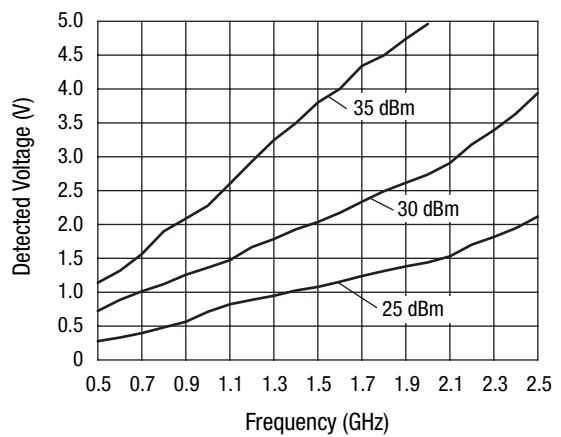

Differential Detected Voltage vs. Frequency & Power

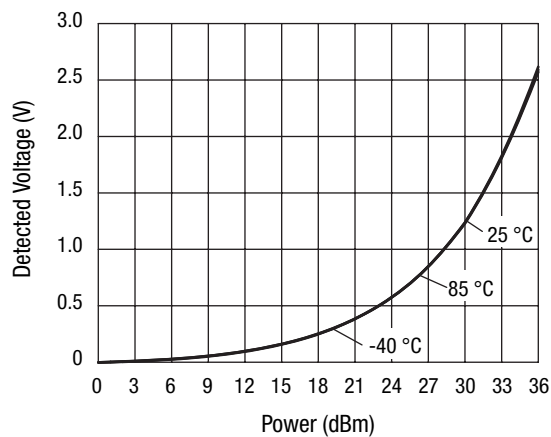

Differential Detected Voltage vs. Power and Temperature @ 900 MHz

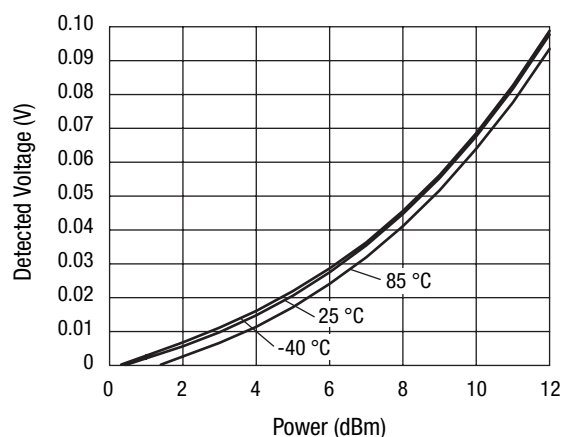

Differential Detected Voltage vs. Power and Temperature @ 900 MHz

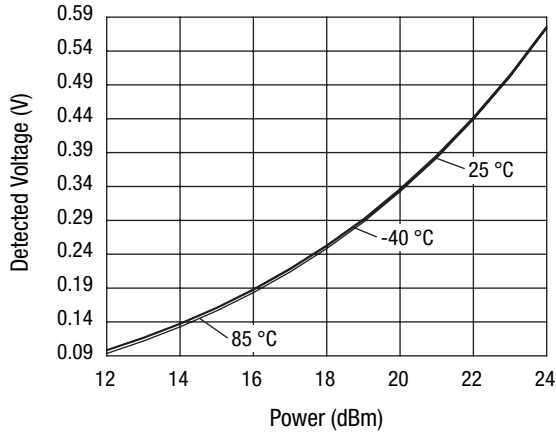

Differential Detected Voltage vs. Power and Temperature @ 900 MHz

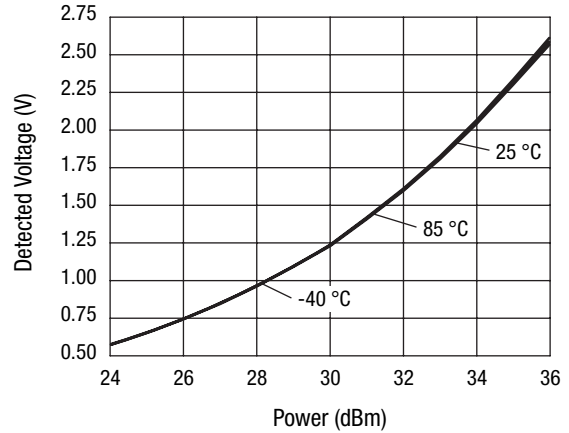

Differential Detected Voltage vs. Power and Temperature @ 900 MHz

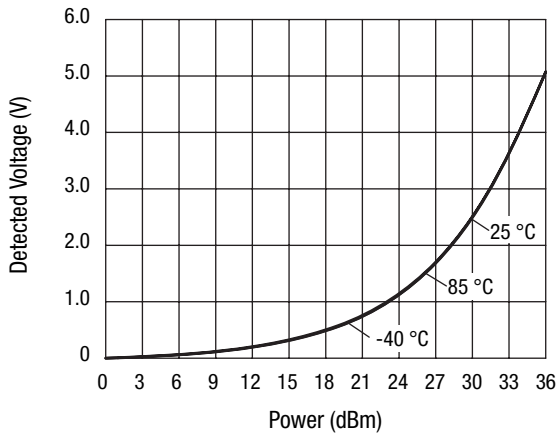

Differential Detected Voltage vs. Power and Temperature @ 1900 MHz

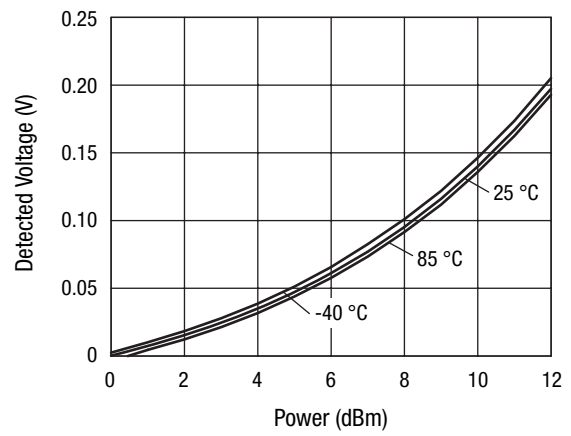

Differential Detected Voltage vs. Power and Temperature @ 1900 MHz

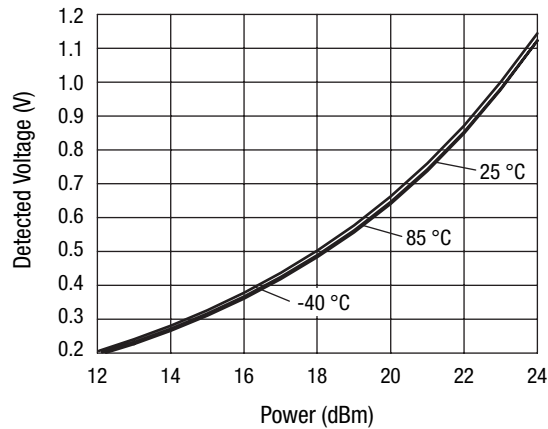

Differential Detected Voltage vs. Power and Temperature @ 1900 MHz

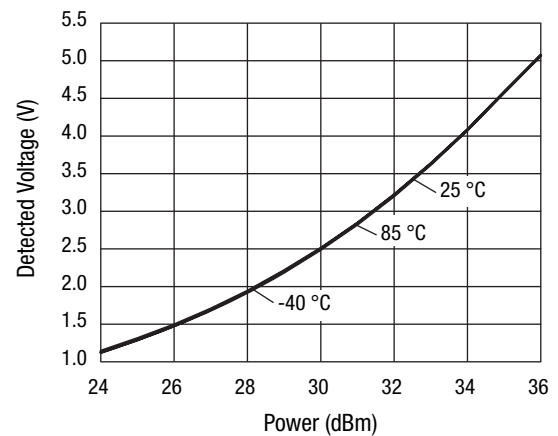

Differential Detected Voltage vs. Power and Temperature @ 1900 MHz

Evaluation Board Layout

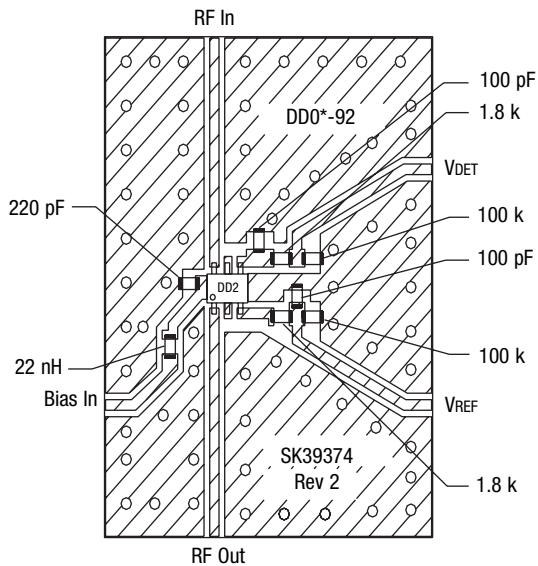

Absolute Maximum Ratings

Characteristic	Value
Incident power (CW) @ SWR = 2 max.	4 W @ < 1 GHz 2 W @ 1–2.5 GHz
DC bias current	10 mA
Operating temperature	-40 °C to +85 °C
Storage temperature	-65 °C to +150 °C
ESD	200 V

Performance is guaranteed only under the conditions listed in the specifications table and is not guaranteed under the full range(s) described by the Absolute Maximum specifications. Exceeding any of the absolute maximum/minimum specifications may result in permanent damage to the device and will void the warranty.

CAUTION: Although this device is designed to be as robust as possible, ESD (Electrostatic Discharge) can damage this device. This device must be protected at all times from ESD. Static charges may easily produce potentials of several kilovolts on the human body or equipment, which can discharge without detection. Industry-standard ESD precautions must be employed at all times.

Application Circuit

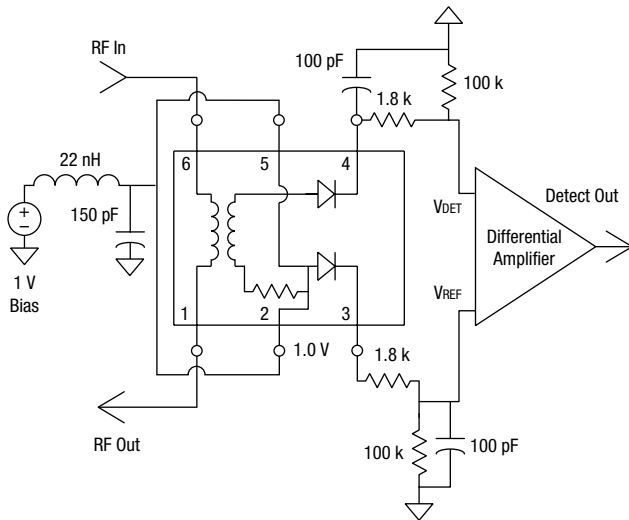

Differential amplifier not included on test board.

SC-88 (6-Lead SC-70)

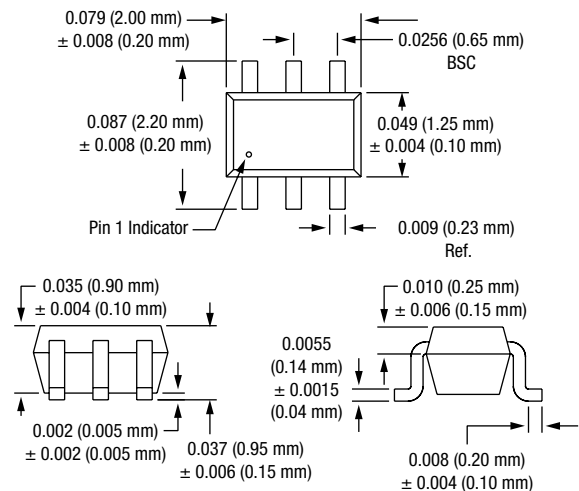

Recommended Solder Reflow Profiles

Refer to the [“Recommended Solder Reflow Profile”](#) Application Note.

Tape and Reel Information

Refer to the [“Discrete Devices and IC Switch/Attenuators Tape and Reel Package Orientation”](#) Application Note.

Copyright © 2002, 2003, 2004, 2005, 2006, Skyworks Solutions, Inc. All Rights Reserved.

Information in this document is provided in connection with Skyworks Solutions, Inc. ("Skyworks") products or services. These materials, including the information contained herein, are provided by Skyworks as a service to its customers and may be used for informational purposes only by the customer. Skyworks assumes no responsibility for errors or omissions in these materials or the information contained herein. Skyworks may change its documentation, products, services, specifications or product descriptions at any time, without notice. Skyworks makes no commitment to update the materials or information and shall have no responsibility whatsoever for conflicts, incompatibilities, or other difficulties arising from any future changes.

No license, whether express, implied, by estoppel or otherwise, is granted to any intellectual property rights by this document. Skyworks assumes no liability for any materials, products or information provided hereunder, including the sale, distribution, reproduction or use of Skyworks products, information or materials, except as may be provided in Skyworks Terms and Conditions of Sale.

THE MATERIALS, PRODUCTS AND INFORMATION ARE PROVIDED "AS IS" WITHOUT WARRANTY OF ANY KIND, WHETHER EXPRESS, IMPLIED, STATUTORY, OR OTHERWISE, INCLUDING FITNESS FOR A PARTICULAR PURPOSE OR USE, MERCHANTABILITY, PERFORMANCE, QUALITY OR NON-INFRINGEMENT OF ANY INTELLECTUAL PROPERTY RIGHT; ALL SUCH WARRANTIES ARE HEREBY EXPRESSLY DISCLAIMED. SKYWORKS DOES NOT WARRANT THE ACCURACY OR COMPLETENESS OF THE INFORMATION, TEXT, GRAPHICS OR OTHER ITEMS CONTAINED WITHIN THESE MATERIALS. SKYWORKS SHALL NOT BE LIABLE FOR ANY DAMAGES, INCLUDING BUT NOT LIMITED TO ANY SPECIAL, INDIRECT, INCIDENTAL, STATUTORY, OR CONSEQUENTIAL DAMAGES, INCLUDING WITHOUT LIMITATION, LOST REVENUES OR LOST PROFITS THAT MAY RESULT FROM THE USE OF THE MATERIALS OR INFORMATION, WHETHER OR NOT THE RECIPIENT OF MATERIALS HAS BEEN ADVISED OF THE POSSIBILITY OF SUCH DAMAGE.

Skyworks products are not intended for use in medical, lifesaving or life-sustaining applications, or other equipment in which the failure of the Skyworks products could lead to personal injury, death, physical or environmental damage. Skyworks customers using or selling Skyworks products for use in such applications do so at their own risk and agree to fully indemnify Skyworks for any damages resulting from such improper use or sale.

Customers are responsible for their products and applications using Skyworks products, which may deviate from published specifications as a result of design defects, errors, or operation of products outside of published parameters or design specifications. Customers should include design and operating safeguards to minimize these and other risks. Skyworks assumes no liability for applications assistance, customer product design, or damage to any equipment resulting from the use of Skyworks products outside of stated published specifications or parameters.

Skyworks, the Skyworks symbol, "Breakthrough Simplicity" and "Innovation to Go" are trademarks or registered trademarks of Skyworks Solutions, Inc., in the United States and other countries. Third-party brands and names are for identification purposes only, and are the property of their respective owners. Additional information, including relevant terms and conditions, posted at www.skyworksinc.com, are incorporated by reference.