



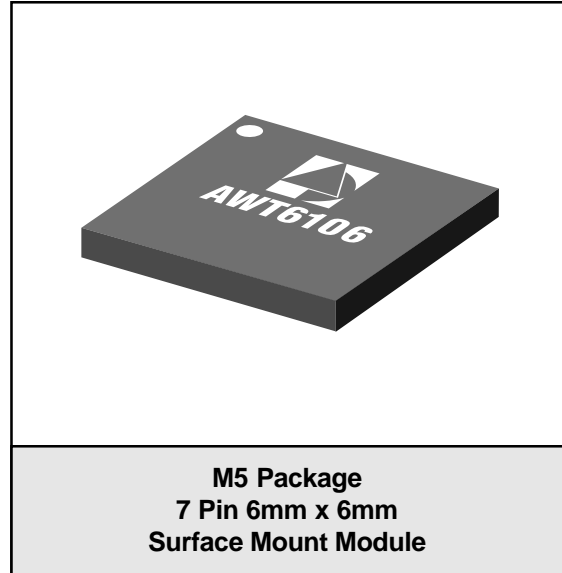
**AWT6106**  
PCS/CDMA 3.5V/28.5dBm  
Linear Power Amplifier Module  
Data Sheet - Rev 2.0

**FEATURES**

- InGaP HBT Technology
- High Efficiency (37% Typical)
- Low Leakage Current (5 $\mu$ A)
- SMT Module Package
- Small Foot Print (6mm x 6mm)
- Low Profile (1.5mm)
- 50  $\Omega$  Input and Output Matching
- Low Quiescent Current (I<sub>cq</sub> = 63 mA)
- Shut Down & Mode Control
- CDMA 2000 IXRTT Compliant

**APPLICATIONS**

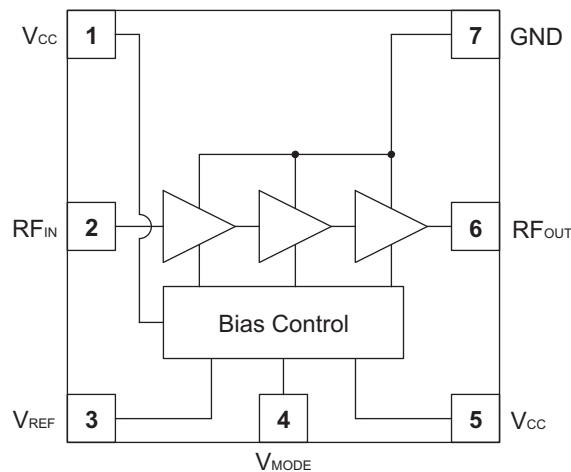
- PCS CDMA handsets
- Dual Band CDMA



**PRODUCT DESCRIPTION**

The AWT6106 is a 3.5 V (3.0 V to 4.2 V) high power, high efficiency, three stage power amplifier module for Dual Mode CDMA/PCS wireless handsets. The device is manufactured on an advanced InGaP HBT MMIC technology offering state-of-the-art reliability, temperature stability, and ruggedness. A low power

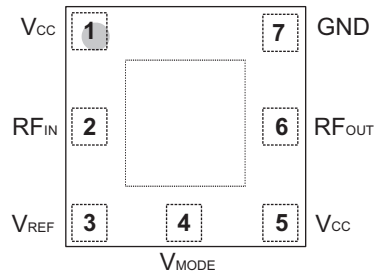
quiescent current mode is digitally controlled to reduce power drain on the system battery. The 6mm x 6mm laminate package is self contained, incorporating 50 $\Omega$  input and output matching networks optimized for output power, linearity, and efficiency.



**Figure 1: Block Diagram**

03/2002

**AWT6106**



**Figure 2: Pinout (X-ray Top View)**

**Table 1: Pin Description**

PIN	NAME	DESCRIPTION
1	VCC	Supply Voltage
2	RFIN	RF Input Signal
3	VREF	Reference Voltage
4	VMODE	Mode Control
5	VCC	Supply Voltage
6	RFOUT	RF Output
7	GND	Ground

## ELECTRICAL CHARACTERISTICS

Table 2: Absolute Minimum and Maximum Ratings

PARAMETER	MIN	MAX	UNITS
Supply Voltage ( $V_{CC}$ )	0	+5	V
Mode Control Voltage ( $V_{MODE}$ )	0	+3.5	V
Reference Voltage ( $V_{REF}$ )	0	+3.5	V
RF Input Power ( $P_{IN}$ )	-	+10	dBm
Storage Temperature ( $T_{STG}$ )	-40	+150	°C

Stresses in excess of the absolute ratings may cause permanent damage. Functional operation is not implied under these conditions. Exposure to absolute ratings for extended periods of time may adversely affect reliability.

Table 3: Operating Ranges

PARAMETER	MIN	TYP	MAX	UNIT	COMMENTS
Operating Frequency (f)	1850	-	1910	MHz	
Supply Voltage ( $V_{CC}$ )	+3.0	+3.5	+4.2	V	
Reference Voltage ( $V_{REF}$ )	+2.75 0	+3.0 -	+3.1 +0.5	V	PA "on" PA "shut down"
Mode Control Voltage ( $V_{MODE}$ )	+2.5 0 0	+2.7 - -	+3.1 +0.5 +0.5	V	Low Bias Mode High Bias Mode PA "shut down"
RF Output Power ( $P_{OUT}$ )	+28	+28.5	-	dBm	
Case Temperature ( $T_C$ )	-30	-	+110	°C	

The device may be operated safely over these conditions; however, parametric performance is guaranteed only over the conditions defined in the electrical specifications.

**Table 4: Electrical Specifications**  
 (  $T_c = +25\text{ }^\circ\text{C}$ ,  $V_{CC} = +3.5\text{ V}$ ,  $V_{REF} = +3.0\text{ V}$ ,  $V_{MODE} = +2.7\text{ V}$ ,  $P_{OUT} = +28.5\text{ dBm}$ ,  $50\ \Omega$  System)

PARAMETER	MIN	TYP	MAX	UNIT	COMMENTS
Gain: High Bias Mode	25.0	29.5	-	dB	$+16 \leq P_{OUT} \leq +28.5\text{ dBm}$
Gain: Low Bias Mode	24.0 23.0	28.5 28.0	- -	dB	$+20 \leq P_{OUT} \leq +28.5\text{ dBm}$ $P_{OUT} \leq +20\text{ dBm}$
Adjacent Channel Power at $\pm 1.25\text{ MHz}$ offset; Primary Channel BW = 1.23 MHz Adjacent Channel BW = 30 kHz	-	-51	-46.5	dB	$P_{OUT} = +28.5\text{ dBm}$ , $V_{CC} = +3.5\text{ V}$ : High or Low Bias Mode
	-	-50	-46.5	dB	$P_{OUT} = +28\text{ dBm}$ , $V_{CC} = +3.2\text{ V}$ : High or Low Bias Mode
Adjacent Channel Power at $\pm 2.25\text{ MHz}$ offset; Primary Channel BW = 1.23 MHz Adjacent Channel BW = 30 kHz	-	-62	-57	dB	$P_{OUT} = +28.5\text{ dBm}$ , $V_{CC} = +3.5\text{ V}$ : High Bias Mode
	-	-59	-57		Low Bias Mode
	-	-62	-57	dB	$P_{OUT} = +28\text{ dBm}$ , $V_{CC} = +3.2\text{ V}$ : High Bias Mode
	-	-59	-57		Low Bias Mode
Efficiency	32	37	-	%	$P_{OUT} = +28.5\text{ dBm}$ , Low Bias Mode
	31	36	-		$P_{OUT} = +28.5\text{ dBm}$ , High Bias Mode
	6	7	-		$P_{OUT} = +16\text{ dBm}$ , Low Bias Mode
Quiescent Current ( $I_{CQ}$ )	-	63	75	mA	Low Bias Mode
Reference Current ( $I_{REF}$ )	-	7	10	mA	through $V_{REF}$ pin
Leakage Current (shutdown mode)	-	<5	10	$\mu\text{A}$	$V_{CC} = +3.5\text{ V}$ , $V_{REF} = 0\text{ V}$ , $V_{MODE} = 0\text{ V}$
Noise in Receive Band	-	-136	-134	dBm/Hz	1930 MHz to 1990 MHz
Harmonics 2fo 3fo, 4fo	-	-45	-30	dBc	
	-	-50	-30		
Input Impedance	-	-	2:1	VSWR	
Spurious Output Level (all spurious outputs)	-	-	-70	dBc	$P_{OUT} \leq +29\text{ dBm}$ In-band load VSWR < 8:1 Out-of-band load VSWR < 8:1 Applies over all voltage and temperature operating ranges
Load mismatch stress with no permanent degradation or failure	8:1	-	-	VSWR	$V_{CC} = +5.0\text{ V}$ $P_{IN} = +5\text{ dBm}$ Applies over full operating temperature range

PERFORMANCE DATA

Figure 3: Large Signal Gain and PAE vs P<sub>OUT</sub>  
 (f = 1880 MHz, V<sub>CC</sub> = +3.7 V, V<sub>REF</sub> = +3.0 V,  
 V<sub>MODE</sub> = +2.7 V)

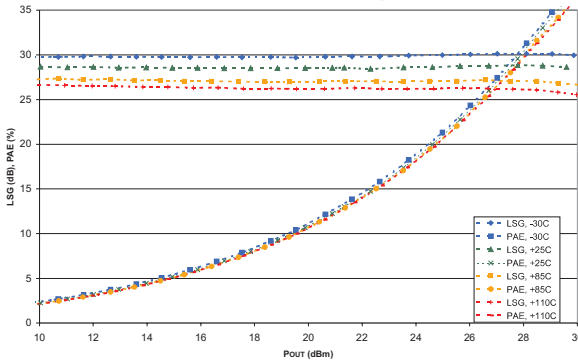


Figure 4: Large Signal Gain and PAE vs P<sub>OUT</sub>  
 (f = 1880 MHz, V<sub>CC</sub> = +3.7 V, V<sub>REF</sub> = +3.0 V,  
 V<sub>MODE</sub> = +2.7 V)

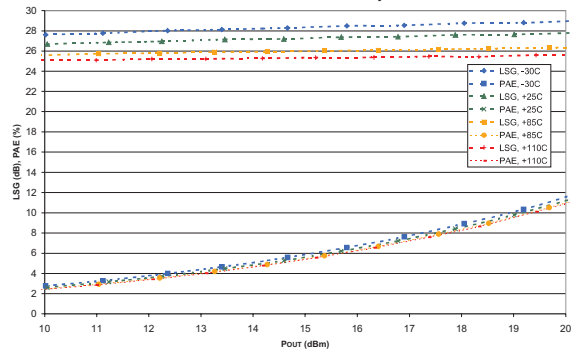


Figure 5: Adjacent Channel Power vs P<sub>OUT</sub>  
 (f = 1880 MHz, V<sub>CC</sub> = +3.7 V, V<sub>REF</sub> = +3.0 V,  
 V<sub>MODE</sub> = 0 V, Δf<sub>ACP</sub> = 1.25 MHz)

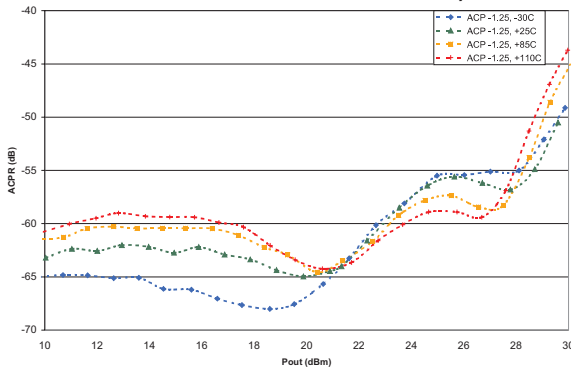


Figure 6: Adjacent Channel Power vs P<sub>OUT</sub>  
 (f = 1880 MHz, V<sub>CC</sub> = +3.7 V, V<sub>REF</sub> = +3.0 V,  
 V<sub>MODE</sub> = +2.7 V, Δf<sub>ACP</sub> = 1.25 MHz)

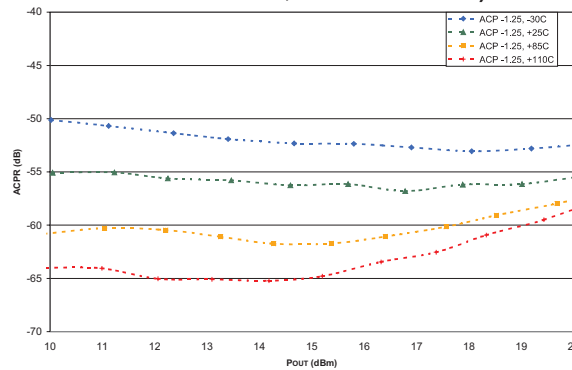


Figure 7: Adjacent Channel Power vs P<sub>OUT</sub>  
 (f = 1880 MHz, V<sub>CC</sub> = +3.7 V, V<sub>REF</sub> = +3.0 V,  
 V<sub>MODE</sub> = 0 V, Δf<sub>ACP</sub> = 2.25 MHz)

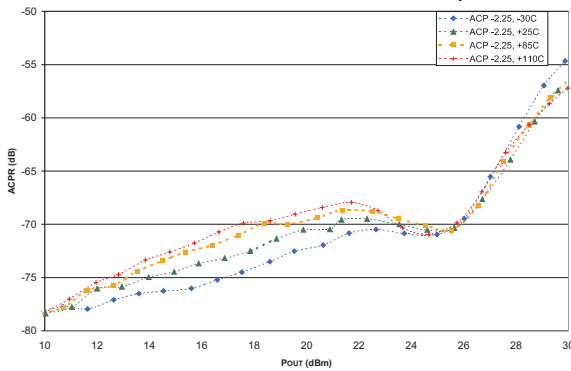
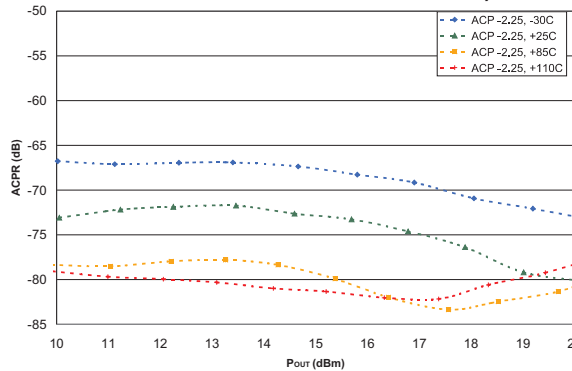
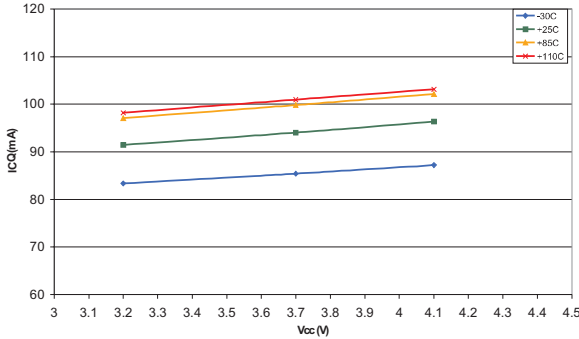


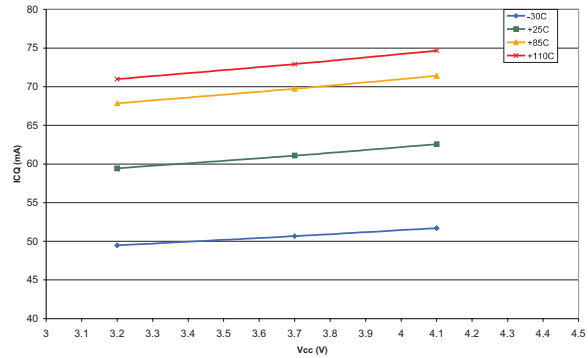
Figure 8: Adjacent Channel Power vs P<sub>OUT</sub>  
 (f = 1880 MHz, V<sub>CC</sub> = +3.7 V, V<sub>REF</sub> = +3.0 V,  
 V<sub>MODE</sub> = +2.7 V, Δf<sub>ACP</sub> = 2.25 MHz)



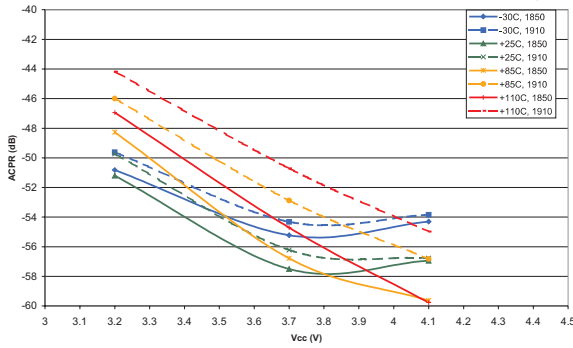
**Figure 9: Quiescent Current vs V<sub>CC</sub>**  
 (V<sub>REF</sub> = +3.0 V, V<sub>MODE</sub> = 0 V)



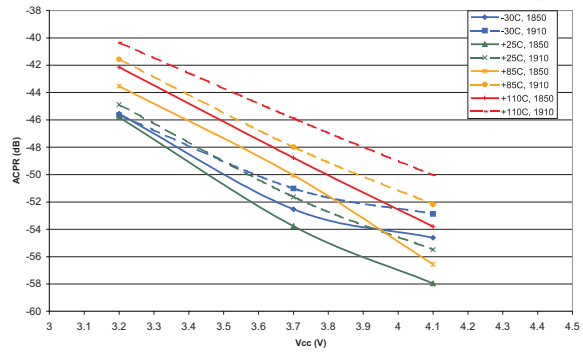
**Figure 10: Quiescent Current vs V<sub>CC</sub>**  
 (V<sub>REF</sub> = +3.0 V, V<sub>MODE</sub> = +2.7 V)



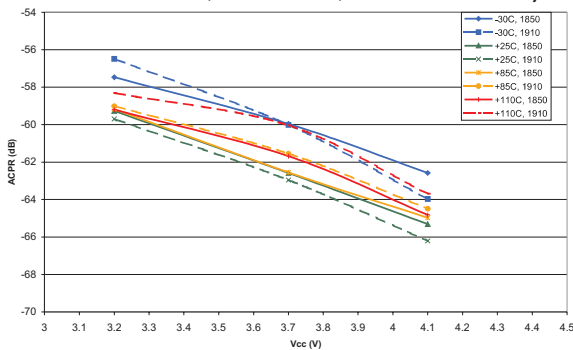
**Figure 11: Adjacent Channel Power vs V<sub>CC</sub>**  
 (f = 1850 & 1910 MHz, P<sub>OUT</sub> = +28 dBm,  
 V<sub>REF</sub> = +3.0 V, V<sub>MODE</sub> = 0 V, Δf<sub>ACP</sub> = 1.25 MHz)



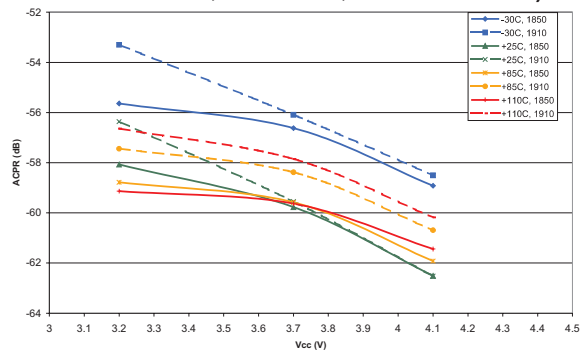
**Figure 12: Adjacent Channel Power vs V<sub>CC</sub>**  
 (f = 1850 & 1910 MHz, P<sub>OUT</sub> = +29 dBm,  
 V<sub>REF</sub> = +3.0 V, V<sub>MODE</sub> = 0 V, Δf<sub>ACP</sub> = 1.25 MHz)



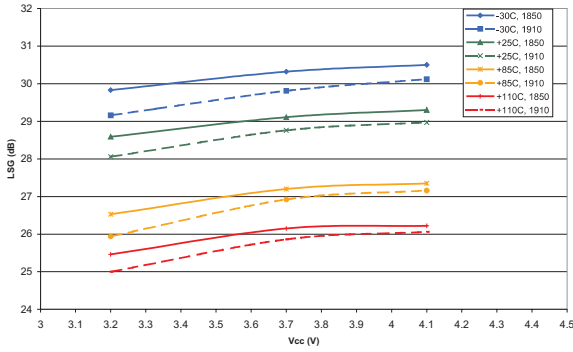
**Figure 13: Adjacent Channel Power vs V<sub>CC</sub>**  
 (f = 1850 & 1910 MHz, P<sub>OUT</sub> = +28 dBm,  
 V<sub>REF</sub> = +3.0 V, V<sub>MODE</sub> = 0 V, Δf<sub>ACP</sub> = 2.25 MHz)



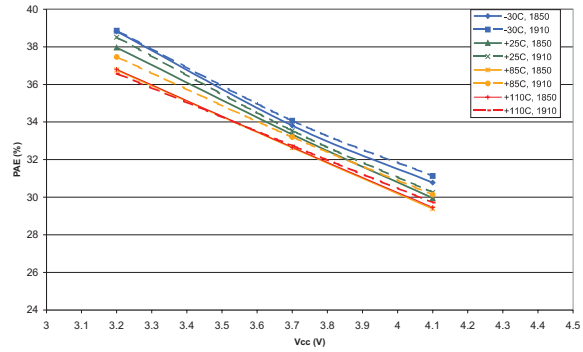
**Figure 14: Adjacent Channel Power vs V<sub>CC</sub>**  
 (f = 1850 & 1910 MHz, P<sub>OUT</sub> = +29 dBm,  
 V<sub>REF</sub> = +3.0 V, V<sub>MODE</sub> = 0 V, Δf<sub>ACP</sub> = 2.25 MHz)



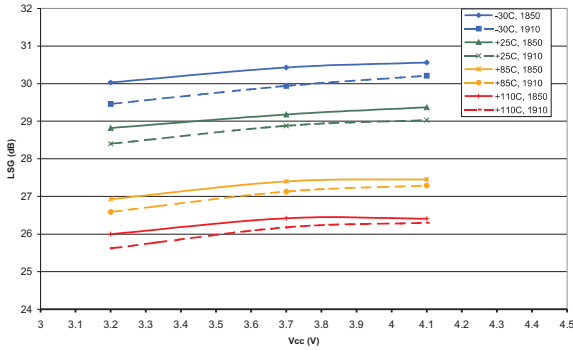
**Figure 15: Large Signal Gain vs V<sub>CC</sub>**  
 (f = 1850 & 1910 MHz, P<sub>OUT</sub> = +29 dBm,  
 V<sub>REF</sub> = +3.0 V, V<sub>MODE</sub> = 0 V)



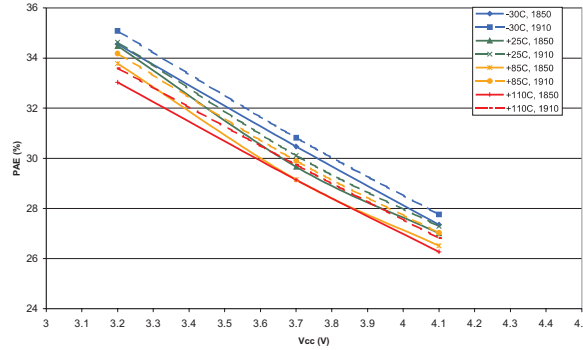
**Figure 16: Power-Added Efficiency vs V<sub>CC</sub>**  
 (f = 1850 & 1910 MHz, P<sub>OUT</sub> = +29 dBm,  
 V<sub>REF</sub> = +3.0 V, V<sub>MODE</sub> = 0 V)



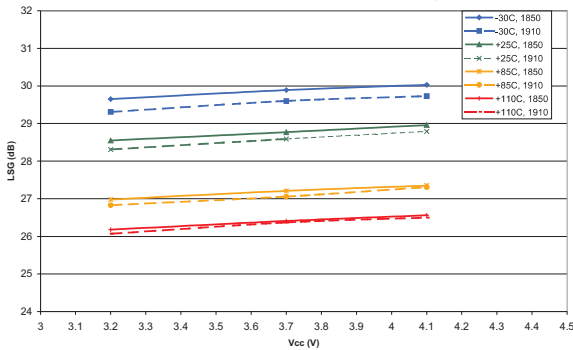
**Figure 17: Large Signal Gain vs V<sub>CC</sub>**  
 (f = 1850 & 1910 MHz, P<sub>OUT</sub> = +28 dBm,  
 V<sub>REF</sub> = +3.0 V, V<sub>MODE</sub> = 0 V)



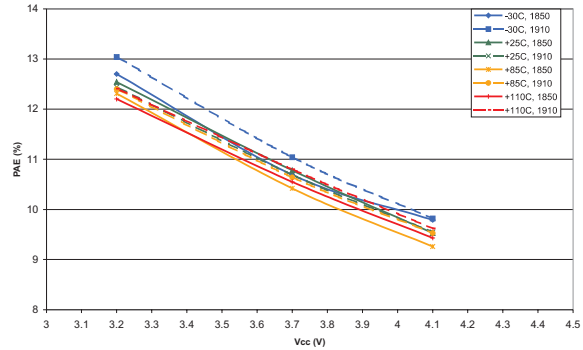
**Figure 18: Power-Added Efficiency vs V<sub>CC</sub>**  
 (f = 1850 & 1910 MHz, P<sub>OUT</sub> = +28 dBm,  
 V<sub>REF</sub> = +3.0 V, V<sub>MODE</sub> = 0 V)



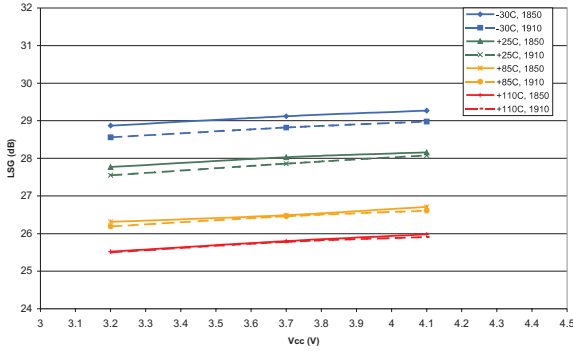
**Figure 19: Large Signal Gain vs V<sub>CC</sub>**  
 (f = 1850 & 1910 MHz, P<sub>OUT</sub> = +20 dBm,  
 V<sub>REF</sub> = +3.0 V, V<sub>MODE</sub> = 0 V)



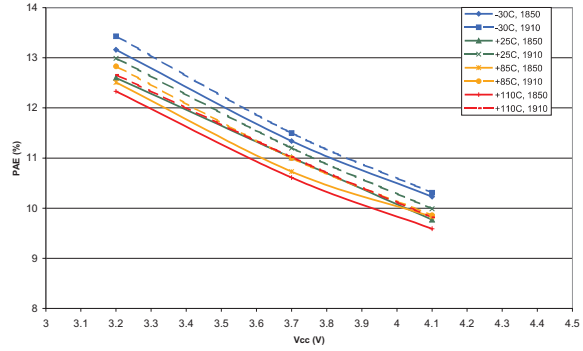
**Figure 22: Power-Added Efficiency vs V<sub>CC</sub>**  
 (f = 1850 & 1910 MHz, P<sub>OUT</sub> = +20 dBm,  
 V<sub>REF</sub> = +3.0 V, V<sub>MODE</sub> = +2.7 V)



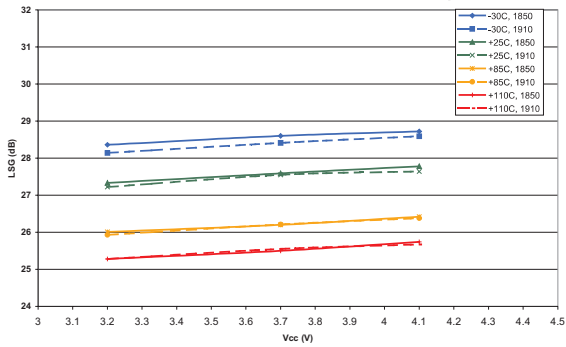
**Figure 21: Large Signal Gain vs V<sub>CC</sub>**  
 (f = 1850 & 1910 MHz, P<sub>OUT</sub> = +20 dBm,  
 V<sub>REF</sub> = +3.0 V, V<sub>MODE</sub> = +2.7 V)



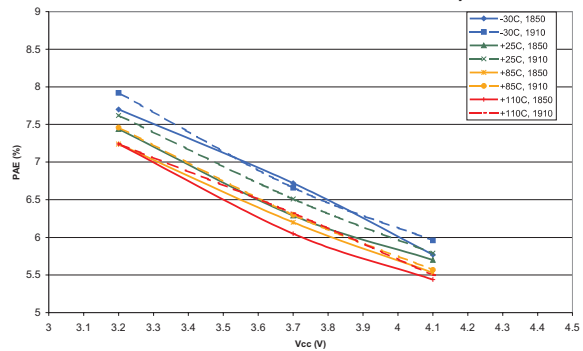
**Figure 22: Power-Added Efficiency vs V<sub>CC</sub>**  
 (f = 1850 & 1910 MHz, P<sub>OUT</sub> = +20 dBm,  
 V<sub>REF</sub> = +3.0 V, V<sub>MODE</sub> = +2.7 V)



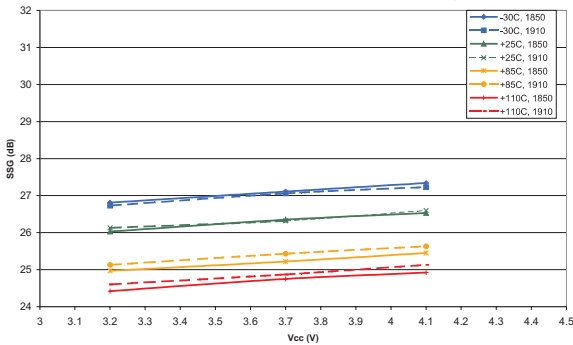
**Figure 23: Large Signal Gain vs V<sub>CC</sub>**  
 (f = 1850 & 1910 MHz, P<sub>OUT</sub> = +16 dBm,  
 V<sub>REF</sub> = +3.0 V, V<sub>MODE</sub> = +2.7 V)



**Figure 24: Power-Added Efficiency vs V<sub>CC</sub>**  
 (f = 1850 & 1910 MHz, P<sub>OUT</sub> = +16 dBm,  
 V<sub>REF</sub> = +3.0 V, V<sub>MODE</sub> = +2.7 V)

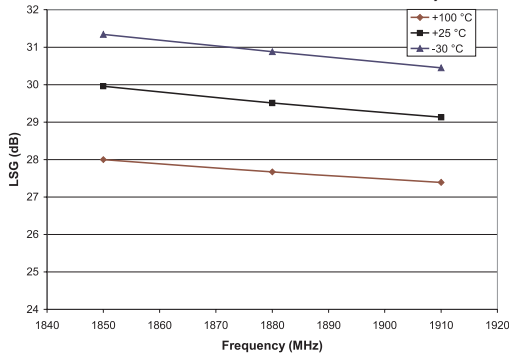


**Figure 25: Small Signal Gain vs V<sub>CC</sub>**  
 (f = 1850 & 1910 MHz, P<sub>IN</sub> = -20 dBm,  
 V<sub>REF</sub> = +3.0 V, V<sub>MODE</sub> = +2.7 V)

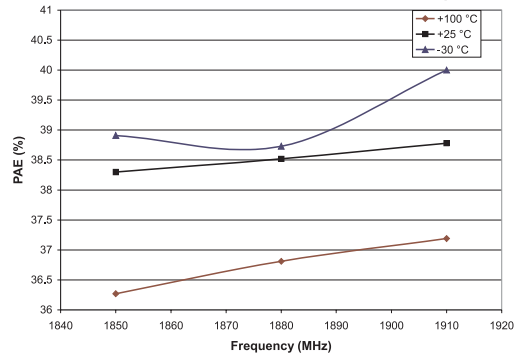




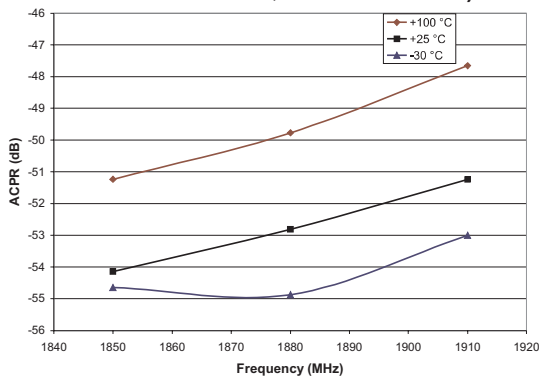
**Figure 26: Large Signal Gain vs Freq.**  
 ( $P_{OUT} = +28.5 \text{ dBm}$ ,  $V_{CC} = +3.5 \text{ V}$ ,  
 $V_{REF} = +2.85 \text{ V}$ ,  $V_{MODE} = +2.85 \text{ V}$ )



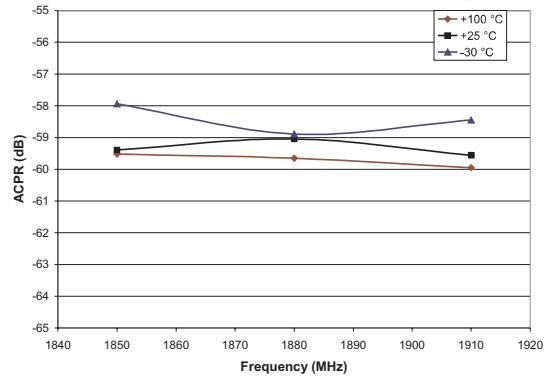
**Figure 27: Power-Added Efficiency vs Freq.**  
 ( $P_{OUT} = +28.5 \text{ dBm}$ ,  $V_{CC} = +3.5 \text{ V}$ ,  
 $V_{REF} = +2.85 \text{ V}$ ,  $V_{MODE} = +2.85 \text{ V}$ )



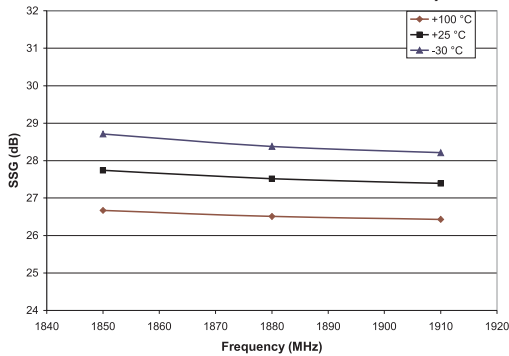
**Figure 28: Adjacent Channel Power vs Freq.**  
 ( $P_{OUT} = +28.5 \text{ dBm}$ ,  $V_{CC} = +3.5 \text{ V}$ ,  $V_{REF} = +2.85 \text{ V}$ ,  
 $V_{MODE} = +2.85 \text{ V}$ ,  $\Delta f_{ACP} = 1.25 \text{ MHz}$ )



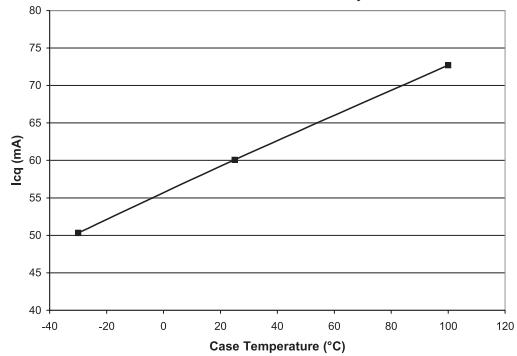
**Figure 29: Adjacent Channel Power vs Freq.**  
 ( $P_{OUT} = +28.5 \text{ dBm}$ ,  $V_{CC} = +3.5 \text{ V}$ ,  $V_{REF} = +2.85 \text{ V}$ ,  
 $V_{MODE} = +2.85 \text{ V}$ ,  $\Delta f_{ACP} = 2.25 \text{ MHz}$ )



**Figure 30: Small Signal Gain vs Freq.**  
 ( $P_{IN} = -20 \text{ dBm}$ ,  $V_{CC} = +3.5 \text{ V}$ ,  
 $V_{REF} = +2.85 \text{ V}$ ,  $V_{MODE} = +2.85 \text{ V}$ )



**Figure 31: Quiescent Current vs Temp.**  
 ( $V_{CC} = +3.5 \text{ V}$ ,  $V_{REF} = +2.85 \text{ V}$ ,  
 $V_{MODE} = +2.85 \text{ V}$ )



## AWT6106

### APPLICATION INFORMATION

To ensure proper performance, refer to all related Application Notes on the ANADIGICS web site: <http://www.anadigics.com>

#### Shutdown Mode

The power amplifier may be placed in a shutdown mode by applying logic low levels (see Operating Ranges table) to the  $V_{REF}$  and  $V_{MODE}$  voltages.

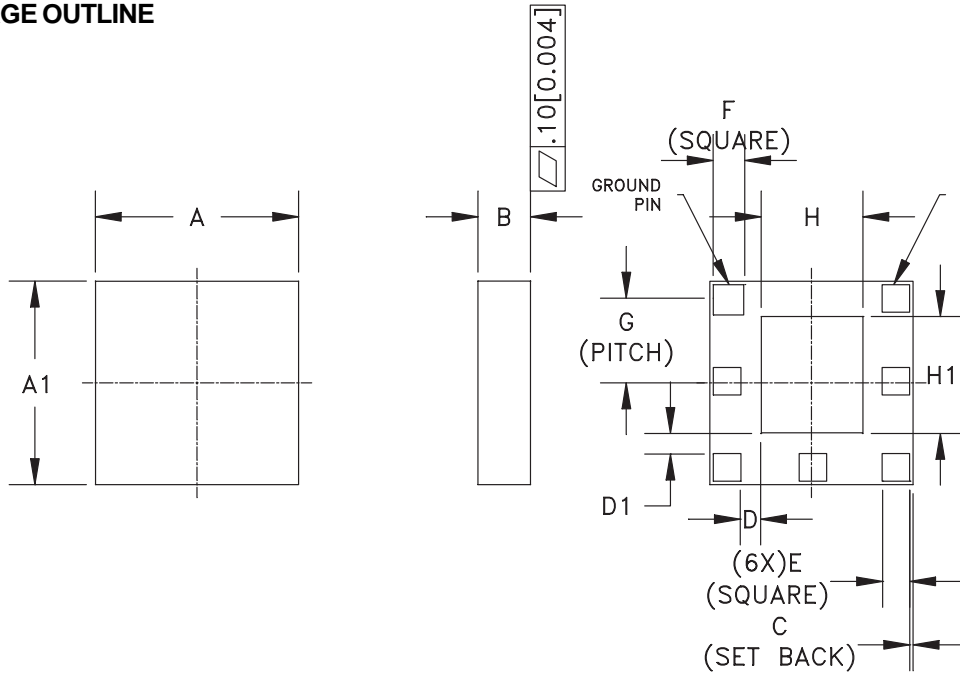
#### Bias Modes

The power amplifier may be placed in either a Low Bias mode or a High Bias mode by applying the appropriate logic level (see Operating Ranges table) to the  $V_{MODE}$  voltage. The Bias Control table lists the recommended modes of operation for various applications.

**Table 5: Bias Control**

APPLICATION	$P_{OUT}$ LEVELS	BIAS MODE	$V_{MODE}$	TYP $I_{cq}$
CDMA PCS - all power levels	$\leq 28.5$ dBm	Low	+2.7 V	65 mA
CDMA PCS - all power levels	$\leq 28.5$ dBm	High	0 V	100 mA

PACKAGE OUTLINE



	MILLIMETERS			INCHES			NOTE
	MIN.	NOM.	MAX.	MIN.	NOM.	MAX.	
A	5.88	6.00	6.12	0.231	0.236	0.241	-
A1	5.88	6.00	6.12	0.231	0.236	0.241	-
B	1.30	1.55	1.70	0.051	0.061	0.067	-
C	-	0.10	-	-	0.004	-	-
D	-	0.60	-	-	0.024	-	-
D1	-	0.60	-	-	0.024	-	-
E	-	0.81	-	-	0.032	-	-
F	-	0.89	-	-	0.035	-	-
G	2.50 BSC			0.098 BSC			3
H	-	3.00	-	-	0.118	-	-
H1	-	3.42	-	-	0.135	-	-

NOTES:

1. CONTROLLING DIMENSIONS: MILLIMETERS
2. UNLESS SPECIFIED TOLERANCE=±0.076[0.003].
3. REFERENCE ONLY.

Figure 32: M5 Package Outline - 7 Pin 6mm x 6mm Surface Mount Module (High Band)



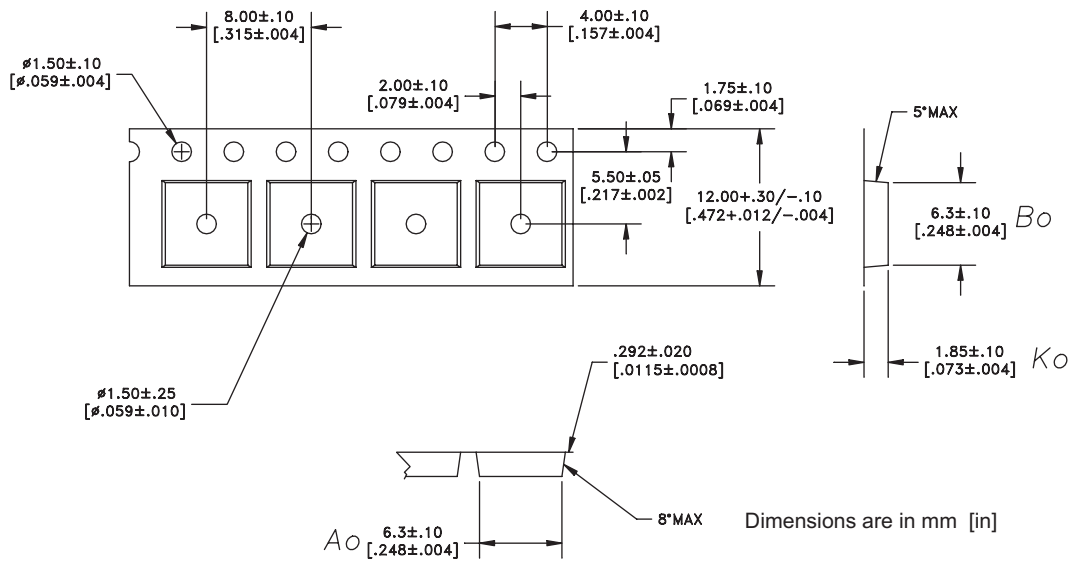
NOTES:

1. ANADIGICS LOGO SIZE: X=0.080±0.010 Y=0.095±0.010
2. PART #: AWT6106
3. YEAR AND WORK WEEK: YYWW: YY = YEAR, WW = WORK WEEK
4. LOT - Wafer I.D.: LLLL-SS = Wafer/Lot I.D.
5. PIN 1 INDICATOR: MOLD NOTCH -or- INK DOT
6. BOM #: BBB
7. COUNTRY CODE: CCCCC
8. TYPE : ELITE  
SIZE : AS LARGE AS POSSIBLE  
COLOR : WHITE or SILVER

Figure 33: Branding Specification

**AWT6106**

**COMPONENT PACKAGING**



**Figure 34: Tape & Reel Packaging**

**Table 6: Tape & Reel Dimensions**

PACKAGE TYPE	TAPE WIDTH	POCKET PITCH	REEL CAPACITY	MAX REEL DIA
6mm X 6mm	12mm	8mm	2500	13"

NOTES

**AWT6106**

**NOTES**

NOTES

**ORDERING INFORMATION**

ORDER NUMBER	TEMPERATURE RANGE	PACKAGE DESCRIPTION	COMPONENT PACKAGING
AWT6106M5P8	-30 °C to +110 °C	7 Pin 6mm x 6mm Surface Mount Module	Tape and Reel, 2500 pieces per Reel

**ANADIGICS, Inc.**

141 Mount Bethel Road  
Warren, New Jersey 07059, U.S.A.  
Tel: +1 (908) 668-5000  
Fax: +1 (908) 668-5132

URL: <http://www.anadigics.com>

E-mail: [Mktg@anadigics.com](mailto:Mktg@anadigics.com)

**IMPORTANT NOTICE**

ANADIGICS, Inc. reserves the right to make changes to its products or to discontinue any product at any time without notice. The product specifications contained in Advanced Product Information sheets and Preliminary Data Sheets are subject to change prior to a product's formal introduction. Information in Data Sheets have been carefully checked and are assumed to be reliable; however, ANADIGICS assumes no responsibilities for inaccuracies. ANADIGICS strongly urges customers to verify that the information they are using is current before placing orders.

**WARNING**

ANADIGICS products are not intended for use in life support appliances, devices or systems. Use of an ANADIGICS product in any such application without written consent is prohibited.