



CEP740A/CEB740A CEI740A/CEF740A

N-Channel Enhancement Mode Field Effect Transistor

FEATURES

Type	V _{DSS}	R _{DS(ON)}	I _D	@V _{GS}
CEP740A	400V	650mΩ	10A	10V
CEB740A	400V	650mΩ	10A	10V
CEI740A	400V	650mΩ	10A	10V
CEF740A	400V	650mΩ	10A ^e	10V

- Super high dense cell design for extremely low R_{DS(ON)}.
- High power and current handling capability.
- Lead free product is acquired.
- TO-220 & TO-263 & TO-262 package & TO-220F full-pak for through hole.

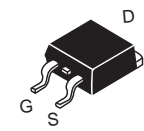

CEB SERIES
TO-263(DD-PAK)

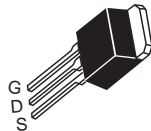

CEI SERIES
TO-262(I2-PAK)

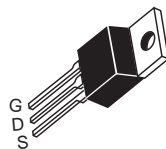

CEP SERIES
TO-220

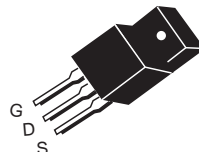

CEF SERIES
TO-220F

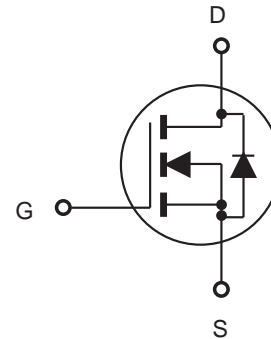

ABSOLUTE MAXIMUM RATINGS $T_C = 25^\circ\text{C}$ unless otherwise noted

Parameter	Symbol	Limit		Units
		TO-220/263/262	TO-220F	
Drain-Source Voltage	V _{DS}	400		V
Gate-Source Voltage	V _{GS}	±30		V
Drain Current-Continuous	I _D	10	10 ^e	A
Drain Current-Pulsed ^a	I _{DM} ^f	40	40 ^e	A
Maximum Power Dissipation @ T _C = 25°C - Derate above 25°C	P _D	125	43	W
		1	0.34	W/°C
Single Pulsed Avalanche Energy ^d	E _{AS}	400	400	mJ
Single Pulsed Avalanche Current ^d	I _{AS}	10	10	A
Operating and Store Temperature Range	T _J , T _{stg}	-55 to 150		°C

Thermal Characteristics

Parameter	Symbol	Limit		Units
Thermal Resistance, Junction-to-Case	R _{θJC}	1.0	2.9	°C/W
Thermal Resistance, Junction-to-Ambient	R _{θJA}	62.5	65	°C/W



CEP740A/CEB740A CEI740A/CEF740A

Electrical Characteristics $T_C = 25^\circ\text{C}$ unless otherwise noted

4

Parameter	Symbol	Test Condition	Min	Typ	Max	Units
Off Characteristics						
Drain-Source Breakdown Voltage	BV_{DSS}	$V_{GS} = 0V, I_D = 250\mu A$	400			V
Zero Gate Voltage Drain Current	I_{DSS}	$V_{DS} = 400V, V_{GS} = 0V$			50	μA
Gate Body Leakage Current, Forward	I_{GSSF}	$V_{GS} = 30V, V_{DS} = 0V$			100	nA
Gate Body Leakage Current, Reverse	I_{GSSR}	$V_{GS} = -30V, V_{DS} = 0V$			-100	nA
On Characteristics^b						
Gate Threshold Voltage	$V_{GS(th)}$	$V_{GS} = V_{DS}, I_D = 250\mu A$	2		4	V
Static Drain-Source On-Resistance	$R_{DS(on)}$	$V_{GS} = 10V, I_D = 6A$			650	m Ω
Forward Transconductance			g_{FS}	$V_{DS} = 50V, I_D = 6A$	3	5.4
Dynamic Characteristics^c						
Input Capacitance	C_{iss}	$V_{DS} = 25V, V_{GS} = 0V, f = 1.0\text{ MHz}$		835		pF
Output Capacitance	C_{oss}			145		pF
Reverse Transfer Capacitance	C_{rss}			85		pF
Switching Characteristics^c						
Turn-On Delay Time	$t_{d(on)}$	$V_{DD} = 200V, I_D = 10A, V_{GS} = 10V, R_{GEN} = 9.1\Omega$		16	75	ns
Turn-On Rise Time	t_r			25	125	ns
Turn-Off Delay Time	$t_{d(off)}$			80	100	ns
Turn-Off Fall Time	t_f			35	60	ns
Total Gate Charge	Q_g	$V_{DS} = 320V, I_D = 10A, V_{GS} = 10V$		52	65	nC
Gate-Source Charge	Q_{gs}			6.5		nC
Gate-Drain Charge	Q_{gd}			27		nC
Drain-Source Diode Characteristics and Maximum Ratings						
Drain-Source Diode Forward Current	I_S^g				10	A
Drain-Source Diode Forward Voltage ^b	V_{SD}	$V_{GS} = 0V, I_S = 10A$			2	V
Notes : a.Repetitive Rating : Pulse width limited by maximum junction temperature . b.Pulse Test : Pulse Width $\leq 300\mu s$, Duty Cycle $\leq 2\%$. c.Guaranteed by design, not subject to production testing. d.L =9.16mH, $I_{AS} = 10A$, $V_{DD} = 50V$, $R_G = 25\Omega$, Starting $T_J = 25^\circ\text{C}$. e.Limited only by maximum temperature allowed . f .Pulse width limited by safe operating area . g.Full package $I_{S(max)} = 5A$.						



CEP740A/CEB740A CEI740A/CEF740A

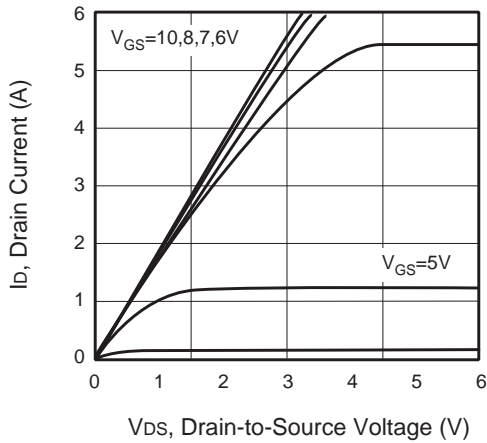

Figure 1. Output Characteristics

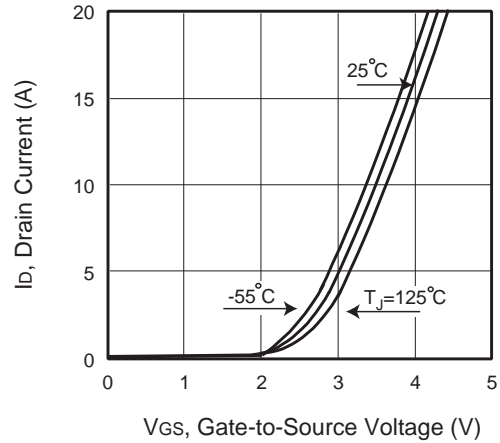

Figure 2. Transfer Characteristics

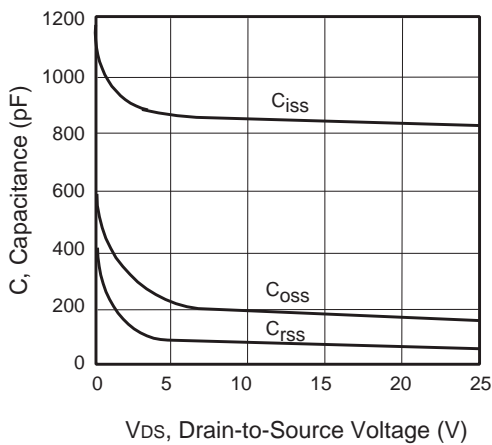

Figure 3. Capacitance

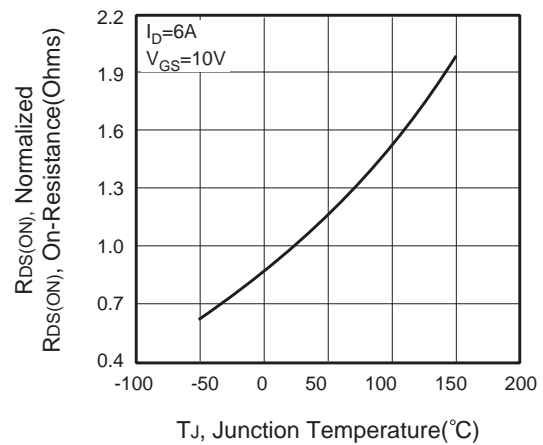

Figure 4. On-Resistance Variation with Temperature

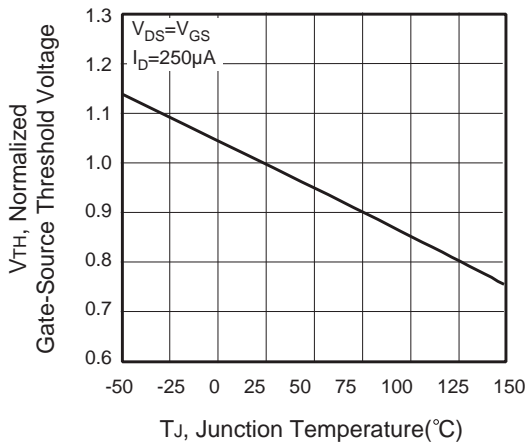

Figure 5. Gate Threshold Variation with Temperature

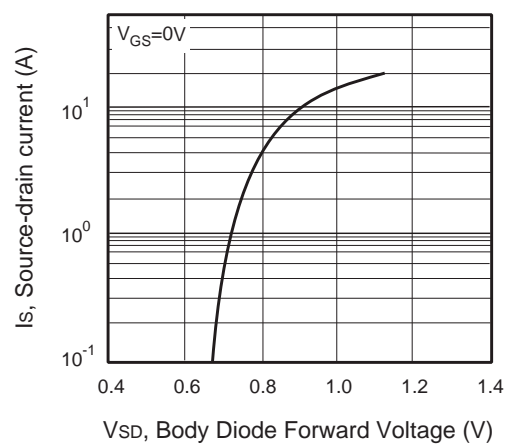

Figure 6. Body Diode Forward Voltage Variation with Source Current



CEP740A/CEB740A CEI740A/CEF740A

4

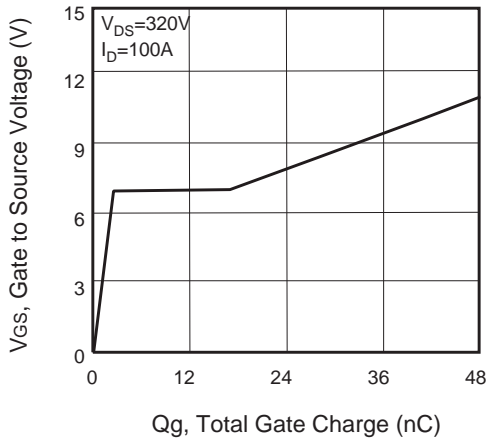

Figure 7. Gate Charge

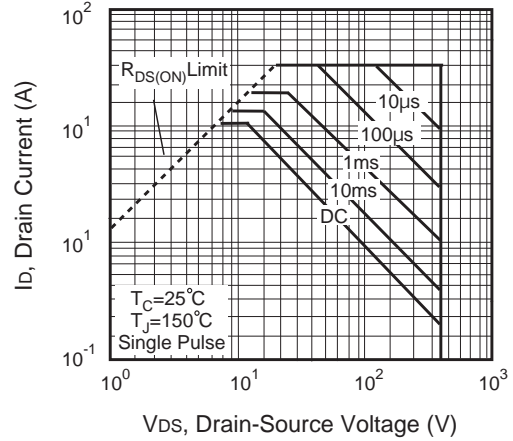

Figure 8. Maximum Safe Operating Area

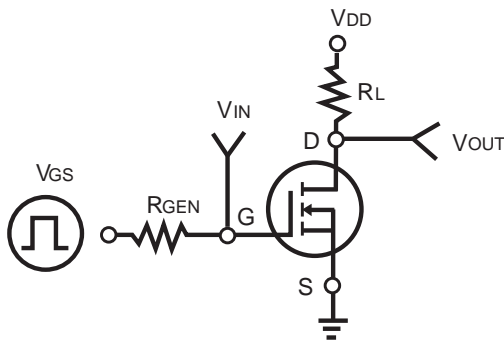

Figure 9. Switching Test Circuit

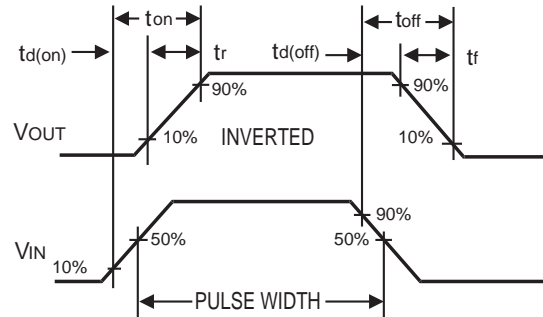

Figure 10. Switching Waveforms

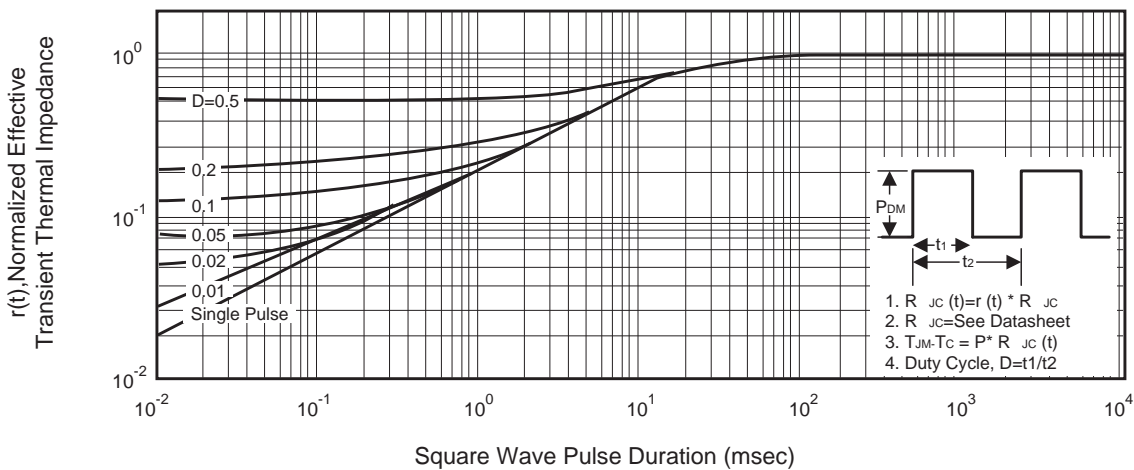

Figure 11. Normalized Thermal Transient Impedance Curve