

Product Description

Stanford Microdevices' SNA-576 is a GaAs monolithic broadband amplifier housed in a low-cost stripline ceramic package. This amplifier provides 19dB of gain when biased at 70mA and 5.0V.

External DC decoupling capacitors determine low frequency response. The use of an external resistor allows for bias flexibility and stability.

These unconditionally stable amplifiers are designed for use as general purpose 50 ohm gain blocks. Also available in chip form (SNA-500), its small size (0.4mm x 0.4mm) and gold metallization make it an ideal choice for use in hybrid circuits.

The SNA-576 is available in tape and reel at 1000, 3000 and 5000 devices per reel.

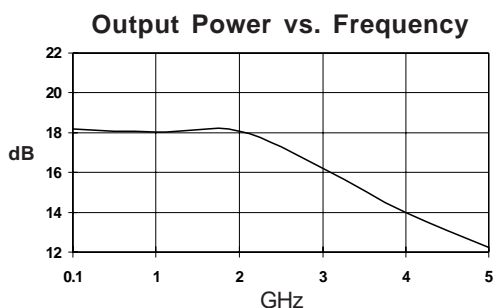

Electrical Specifications at Ta = 25C

Symbol	Parameters: Test Conditions: I _d = 70 mA, Z ₀ = 50 Ohms	Units	Min.	Typ.	Max.
G _P	Small Signal Power Gain	f = 0.1-1.0 GHz f = 1.0-2.0 GHz f = 2.0-3.0 GHz	dB dB dB	18.0 16.0 15.0	20.0 18.0 17.0
G _F	Gain Flatness	f = 0.1-2.0 GHz	dB		+/- 1.0
BW _{3dB}	3dB Bandwidth		GHz	3.0	
P _{1dB}	Output Power at 1dB Compression	f = 2.0 GHz	dBm	18.0	
NF	Noise Figure	f = 2.0 GHz	dB	4.2	5.0
VSWR	Input / Output	f = 0.1-8.0 GHz		1.5:1	
IP ₃	Third Order Intercept Point	f = 2.0 GHz	dBm	34.0	
T _D	Group Delay	f = 2.0 GHz	psec	120	
ISOL	Reverse Isolation	f = 0.1-8.0 GHz	dB	22.0	
VD	Device Voltage		V	4.3	5.7
dG/dT	Device Gain Temperature Coefficient		dB/degC	-0.0027	
dV/dT	Device Voltage Temperature Coefficient		mV/degC	-5.0	

The information provided herein is believed to be reliable at press time. Stanford Microdevices assumes no responsibility for inaccuracies or omissions. Stanford Microdevices assumes no responsibility for the use of this information, and all such information shall be entirely at the user's own risk. Prices and specifications are subject to change without notice. No patent rights or licenses to any of the circuits described herein are implied or granted to any third party. Stanford Microdevices does not authorize or warrant any Stanford Microdevices product for use in life-support devices and/or systems. Copyright 1999 Stanford Microdevices, Inc. All worldwide rights reserved.

SNA-576

DC-3 GHz, Cascadable GaAs MMIC Amplifier



Product Features

- Cascadable 50 Ohm Gain Block
- 19dB Gain, +18dBm P1dB
- 1.5:1 Input and Output VSWR
- Operates From Single Supply
- Low Cost Stripline Mount Ceramic Package
- Hermetically Sealed

Applications

- Narrow and Broadband Linear Amplifiers
- Commercial and Industrial Applications

SNA-576 DC-3 GHz Cascadable MMIC Amplifier

Typical Performance at 25°C ($V_{ds} = 5.0V$, $I_{ds} = 70mA$)

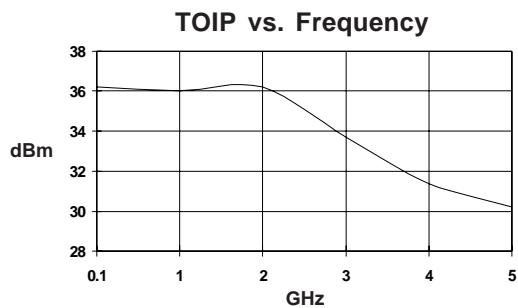
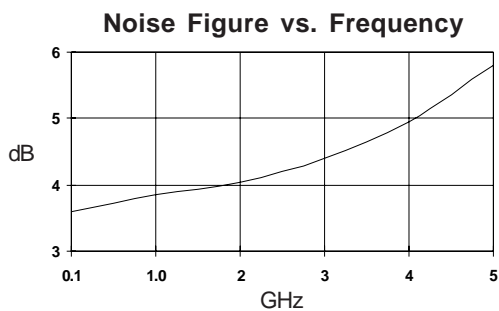
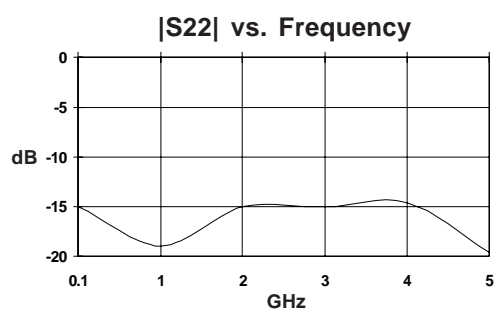
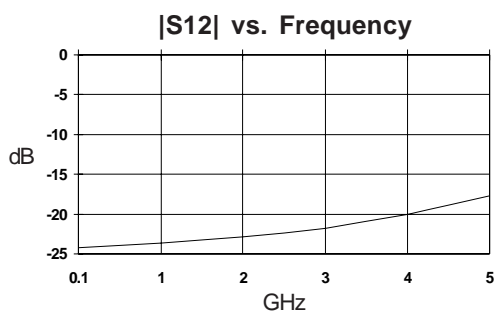
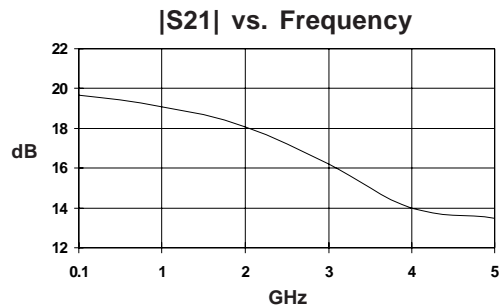
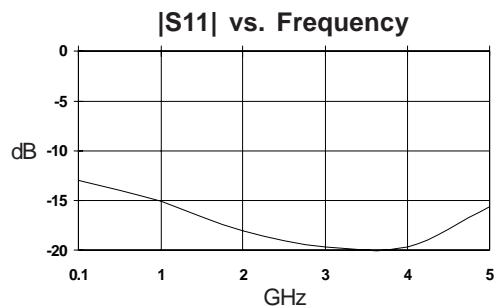

Typical S-Parameters $V_{ds} = 5.0V$, $I_{ds} = 70mA$

Freq GHz	S11	S11 Ang	S21	S21 Ang	S12	S12 Ang	S22	S22 Ang
.100	0.219	156	10.104	-76	0.065	106	0.178	-124
.250	0.146	173	10.087	-44	0.078	147	0.110	-152
.500	0.179	110	8.744	134	0.079	-26	0.152	131
1.00	0.190	51	8.302	92	0.080	-49	0.180	85
1.50	0.183	-7	7.747	46	0.081	-76	0.212	33
2.00	0.153	-56	7.348	5	0.083	-100	0.230	-13
2.50	0.106	-106	6.651	-40	0.085	-128	0.233	-63
3.00	0.050	-153	5.943	-78	0.087	-154	0.219	-107

(S-Parameters include the effects of two 1.0 mil diameter bond wires, each 20 mils long, connected to the gate and drain pads on the die)

SNA-576 DC-3 GHz Cascadable MMIC Amplifier

Absolute Maximum Ratings

Parameter	Absolute Maximum
Device Current	100mA
Power Dissipation	560mW
RF Input Power	200mW
Junction Temperature	+200C
Operating Temperature	-45C to +85C
Storage Temperature	-65C to +150C

Notes:

1. Operation of this device above any one of these parameters may cause permanent damage.

Part Number Ordering Information

Part Number	Devices Per Reel	Reel Size
SNA-576-TR1	1000	7"
SNA-576-TR2	3000	13"
SNA-576-TR3	5000	13"

Recommended Bias Resistor Values

Supply Voltage (Vs)	5V	7.5V	9V	12V	15V	20V
Rbias (Ohms)	*	36	57	100	143	214

* Needs active biasing for constant current source

MTTF vs. Temperature @ Id = 70mA

Lead Temperature	Junction Temperature	MTTF (hrs)
+45C	+155C	1000000
+80C	+190C	100000
+110C	+220C	10000

Thermal Resistance (Lead-Junction): 315° C/W

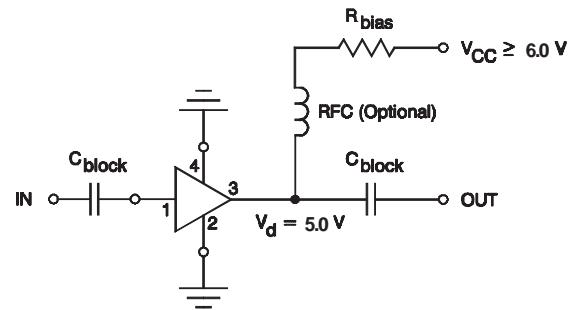

Typical Biasing Configuration

Pin Designation	
1	RF in
2	GND
3	RF out and Bias
4	GND

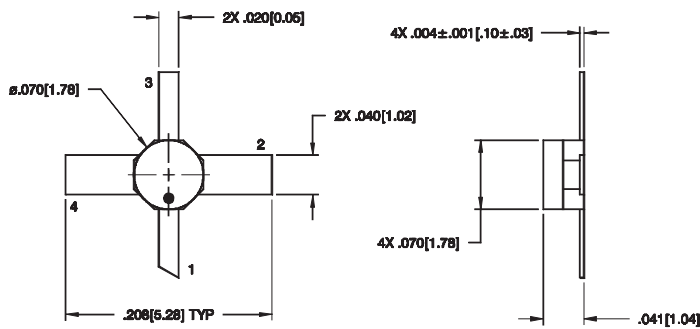

Typical Performance at 25° C

