

General Description

The ILC803, ILC809 and ILC810 are low cost microprocessor supervisory circuits that assert a reset if the power supply drops below a designated threshold. Several different reset thresholds are available to accommodate systems operating at 3V, 3.3V or 5V.

The ILC803 has an open drain output stage with active low RESET output

The ILC809 has an active low RESET output, while the ILC810 offers an active high RESET output. The reset output is guaranteed to remain asserted for a minimum of 140ms after V_{CC} has risen above the designated reset threshold. The ILC803, ILC809 and ILC810 are available in either a 3-Pin SOT-23 package or a 3-Pin SC-70 packages.

Package Features

- Precision Voltage Monitor for 3V, 3.3V or 5V Power Supplies
- 6 μ A Supply Current
- 140ms Minimum Reset Pulse Width
- RESET Remains Valid with V_{CC} as Low as 1.4V
- Active Low Manual Reset Input
- No External Components
- 3-Pin SOT-23 Package
- 3-Pin SC-70 package option

Applications

- Critical Microprocessor Power Monitoring
- Portable Equipment
- Intelligent Instruments
- Computers & Printers, Controllers

Typical Circuit

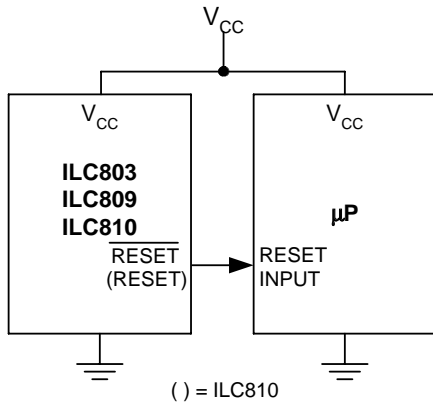

Ordering Information

Part	Package	Temp. Range
ILC803_U	3-Lead SOT-23	-40°C to +85°C
ILC809_U	3-Lead SOT-23	-40°C to +85°C
ILC810_U	3-Lead SOT-23	-40°C to +85°C
ILC803_W	3-Lead SC-70	-40°C to +85°C
ILC809_W	3-Lead SC-70	-40°C to +85°C
ILC810_W	3-Lead SC-70	-40°C to +85°C

Place the device suffix of the desired reset threshold voltage from the table [below] in the blank to complete the part number.

Pin Package Configurations

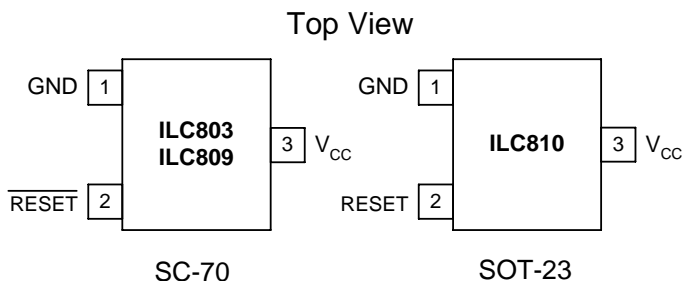

Reset Threshold Voltage (V)	Device Suffix
4.63	L
4.38	M
4.00	J
3.08	T
2.93	S
2.63	R

Absolute Maximum Ratings

Parameter	Symbol	Ratings	Units
Terminal Voltage	V_{CC}	-0.3 to 6.0	V
Input Current	V_{CC}	20	mA
Output Current	RESET, $\overline{\text{RESET}}$	20	mA
Rate of Rise	V_{CC}	100	V/ μ s
Operating Temperature Range	T_A	-40 to +85	$^{\circ}$ C
Storage Temperature Range		-65 to +150	$^{\circ}$ C
Lead Temperature (Soldering, 10 sec.)		300	$^{\circ}$ C
Power Dissipation ($T_A = +70^{\circ}$ C)		320	mW

Stresses above those listed under ABSOLUTE MAXIMUM RATINGS may cause permanent device failure. Functionality at or above these limits is not implied. Exposure to absolute maximum ratings for extended periods may affect device reliability. Operating ranges define those limits between which the functionality of the device is guaranteed.

Electrical Characteristics

$V_{CC} = 5V$ for ILC8__L/M/J, $V_{CC} = 3.3V$ for ILC8__S/T, $V_{CC} = 3V$ for ILC8__R, $T_A =$ Operating Temperature Range, unless otherwise noted.					
Parameter	Conditions	Min	Typ	Max	Units
Operating Voltage Range, V_{CC}	$T_A = 0^{\circ}\text{C to }70^{\circ}\text{C}$ $T_A = -40^{\circ}\text{C to }85^{\circ}\text{C}$	1.4 1.6		5.5 5.5	V
Supply Current, I_{CC}	ILC803L/M/J, ILC809L/M/J, ILC810L/M/J $V_{CC} < 3.6V$, ILC803R/S/T, ILC809R/S/T, ILC810R/S/T		9 6	15 10	μ A
Reset Voltage Threshold, V_{TH}	ILC803L, ILC809L, ILC810L ILC803M, ILC809M, ILC810M ILC803J, ILC809J, ILC810J ILC803T, ILC809T, ILC810T ILC803S, ILC809S, ILC810S ILC803R, ILC809R, ILC810R	4.50 4.25 3.89 3.00 2.85 2.55	4.63 4.38 4.00 3.08 2.93 2.63	4.75 4.50 4.10 3.15 3.00 2.70	V
Reset Timeout Period, t_R		140	240	560	ms
$\overline{\text{RESET}}$ Output Voltage Low (Active low ILC803 & 809) V_{OL}	$V_{CC} = V_{TH}$ $I_{SINK} = 1.2\text{mA}$ $V_{CC} = V_{TH}$ $I_{SINK} = 3.2\text{mA}$			0.3 0.4	V
$\overline{\text{RESET}}$ Open Drain Output Leakage Current	$V_{CC} > V_{TH}$ $\overline{\text{RESET}}$ Deasserted			7	μ A
$\overline{\text{RESET}}$ Output Voltage V_{OH}	$I_{SOURCE} = 800\ \mu\text{A}$, ILC809L/M/J $I_{SOURCE} = 500\ \mu\text{A}$, ILC809R/S/T	$V_{CC} - 1.5$ $0.8 \times V_{CC}$			V
$\overline{\text{RESET}}$ Output Voltage, V_{OL}	$V_{CC} = V_{TH}$ Min., $I_{SINK} = 3.2\ \text{mA}$, ILC809L/M/J $V_{CC} = V_{TH}$ Min., $I_{SINK} = 1.2\ \text{mA}$, ILC809R/S/T $V_{CC} > 1.4\ \text{V}$, $I_{SINK} = 50\ \mu\text{A}$, $T_A = 0^{\circ}\text{C to }70^{\circ}\text{C}$ $V_{CC} > 1.6\ \text{V}$, $I_{SINK} = 50\ \mu\text{A}$, $T_A = -40^{\circ}\text{C to }85^{\circ}\text{C}$			0.4 0.3 0.3 0.3	V
RESET Output Voltage, V_{OH}	$1.8V < V_{CC} < V_{TH}$ Min., $I_{SOURCE} = 150\ \mu\text{A}$	$0.8 \times V_{CC}$			V
RESET Output Voltage, V_{OL}	$I_{SINK} = 3.2\text{mA}$, ILC810L/M/J $I_{SINK} = 1.2\text{mA}$, ILC810R/S/T			0.4 0.3	V

Pin Functions

Pin Name	Pin Number			Description
	ILC803	ILC809	ILC810	
GND	1	1	1	Ground Pin.
RESET	2	2	N/A	RESET goes low if V_{CC} falls below the reset threshold and remains asserted for one reset timeout period (140ms min.) after V_{CC} exceeds the reset threshold.
RESET	N/A	N/A	2	RESET goes high if V_{CC} falls below the reset threshold and remains asserted for one reset timeout period (140ms min.) after V_{CC} exceeds the reset threshold.
V_{CC}	4	3	3	Power supply input, 3 V, 3.3 V or 5 V.

Circuit Description

Microprocessor Reset

The $\overline{\text{RESET}}$ pin is asserted whenever V_{CC} falls below the reset threshold voltage. The reset pin remains asserted for a period of 240ms after V_{CC} has risen above the reset threshold voltage. The reset function ensures the microprocessor is properly reset and powers up into a known condition after a power failure. $\overline{\text{RESET}}$ will remain valid with V_{CC} as low as 1.4V.

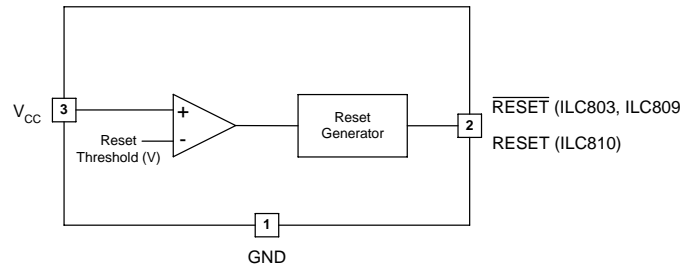

Figure 3: Block Diagram

Alternate Source Cross Reference Guide

Industry P/N	ILC Direct Replacement
MAX803XYUR-T	ILC803YU
MAX809JEUR-T	ILC809JU
MAX809LEUR-T	ILC809LU
MAX809MEUR-T	ILC809MU
MAX809REUR-T	ILC809RU
MAX809SEUR-T	ILC809SU
MAX809TEUR-T	ILC809TU
MAX810JEUR-T	ILC810JU
MAX810LEUR-T	ILC810LU
MAX810MEUR-T	ILC810MU
MAX810REUR-T	ILC810RU
MAX810SEUR-T	ILC810SU
MAX810TEUR-T	ILC810TU

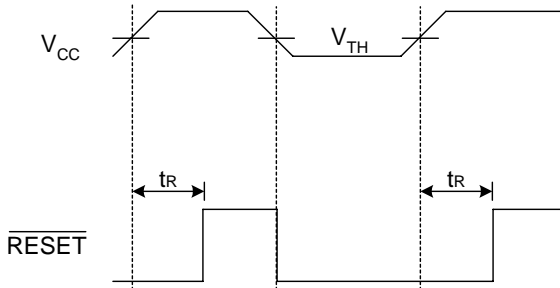

Figure 1: Timing Diagram

V_{CC} Transients

The ILC803, ILC809 and ILC810 are relatively immune to negative-going V_{CC} glitches below the reset threshold. Typically, a negative-going transient 125mV below the reset threshold with a duration of 50 μ s (25 μ s for ILC8__R/S/T) or less will not cause an unwanted reset.

Interfacing to Bi-directional Reset Pins

The ILC803/ILC809/ILC810 can interface with μ Ps with bi-directional reset pins by connecting a 4.7k Ω resistor in series with the ILC803/ILC809/ILC810 output and the μ P reset pin. ILC803 connects directly with a single pull-up resistor (figure 2).

RESET Valid to 0V

A resistor can be added from the $\overline{\text{RESET}}$ pin to ground to ensure the $\overline{\text{RESET}}$ output remains low with V_{CC} down to 0V. A 100k Ω resistor connected from $\overline{\text{RESET}}$ to ground is recommended. The size of the resistor should be large enough to not load the RESET output and small enough to pull-down any stray leakage currents.

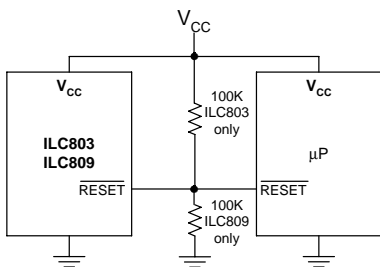

Figure 2: Reset valid to V_{CC}

Device Markings Information

	SC-70 Case	SOT-23 Case
ILC803J	QJY	QJYY
ILC803L	QLY	QLYY
ILC803M	QMY	QMYY
ILC803R	QRY	QRYY
ILC803S	QSY	QSYY
ILC803T	QTY	QTY
ILC809J	VJY	VJYY
ILC809L	VLY	VLY
ILC809M	VMY	VMYY
ILC809R	VR	VRYY
ILC809S	VS	VSYY
ILC809T	VT	VTYY
ILC810J	ZJY	ZJYY
ILC810L	ZCY	ZCYY
ILC810M	ZMY	ZMY
ILC810R	ZRY	ZRY
ILC810S	ZSY	ZSY
ILC810T	ZTY	ZTY
	Y-LOT CODE	YY-LOT CODE

Packaging Information

U Package, 3-Pin SOT-23

Dimensions are in inches

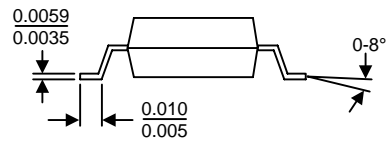
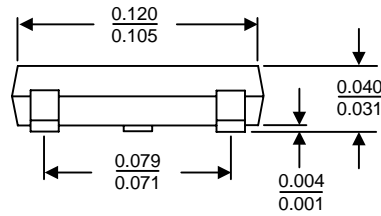
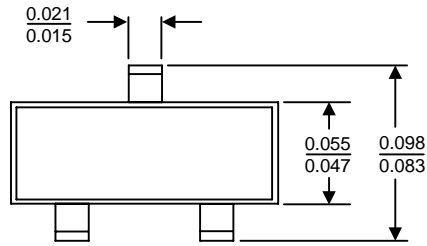

W Package, 3-Pin SC-70

Dimensions are in inches

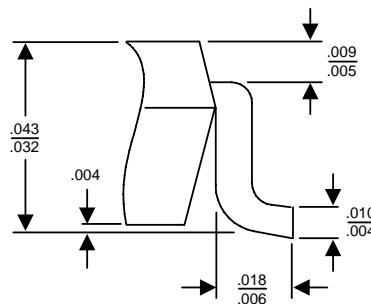
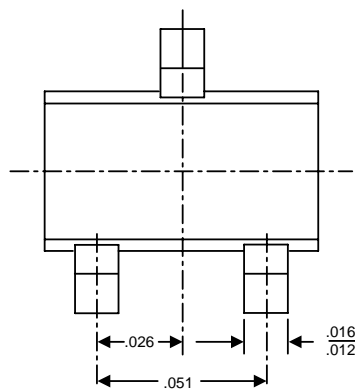
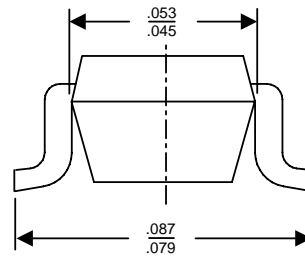
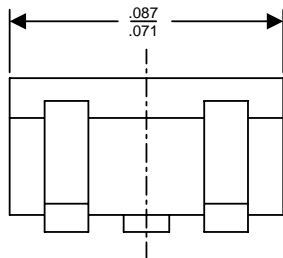

Tape and Reel Information

Diagram applies to SOT-23 and SC-70

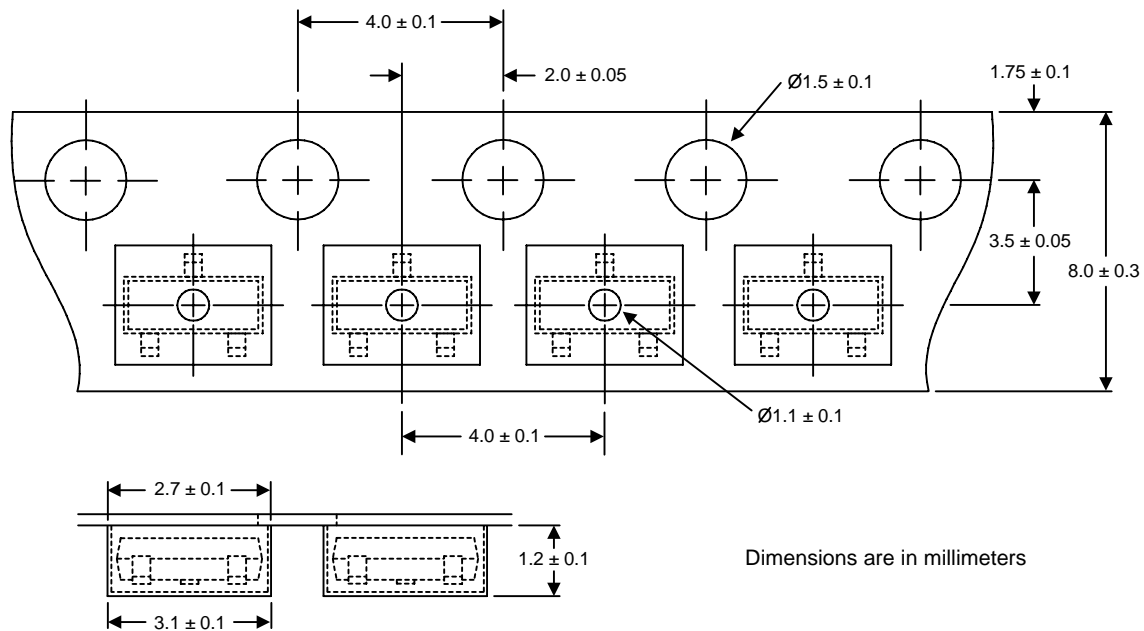

Devices sold by Impala Linear Corporation are covered by the warranty and patent indemnification provisions appearing in its Terms of Sale only. Impala Linear Corporation makes no warranty, express, statutory, implied, or by description regarding the information set forth herein or regarding the freedom of the described devices from patent infringement. Impala Linear Corporation makes no warranty of merchantability or fitness for any purpose. Impala Linear Corporation reserves the right to discontinue production and change specifications and prices at any time and without notice.

This product is intended for use in normal commercial applications. Applications requiring an extended temperature range, unusual environmental requirements, or high reliability applications, such as military and aerospace, are specifically not recommended without additional processing by Impala Linear Corporation.

Impala Linear Corporation assumes no responsibility for the use of any circuitry other than circuitry embodied in an Impala Linear Corporation product. No other circuits, patents, licenses are implied.

Life Support Policy

Impala Linear Corporation's products are not authorized for use as critical components in life support devices or systems.

1. Life support devices or systems are devices or systems which, (a) are intended for surgical implant into the body, or (b) support or sustain life, and whose failure to perform, when properly used in accordance with instructions for use provided in the labelling, can be reasonably expected to result in a significant injury to the user.
2. A critical component is any component of a life support device or system whose failure to perform can be reasonably expected to cause the failure of the life support device or system, or to affect its safety or effectiveness.