

Low-Noise, Fixed Output Voltage, 200mA/500mA LDO Regulator

General Description

The RT9167/A is a 200mA/500mA low dropout and low noise micropower regulator suitable for portable applications. The output voltages range from 1.5V to 5.0V in 100mV increments and 2% accuracy. The RT9167/A is designed for use with very low ESR capacitors. The output remains stable even with 1μF ceramic output capacitor.

The RT9167/A uses an internal PMOS as the pass device, which does not cause extra GND current in heavy load and dropout conditions. The shutdown mode of nearly zero operation current makes the IC suitable for battery-power devices. Other features include a reference bypass pin to improve low noise performance, current limiting, and over temperature protection.

Ordering Information

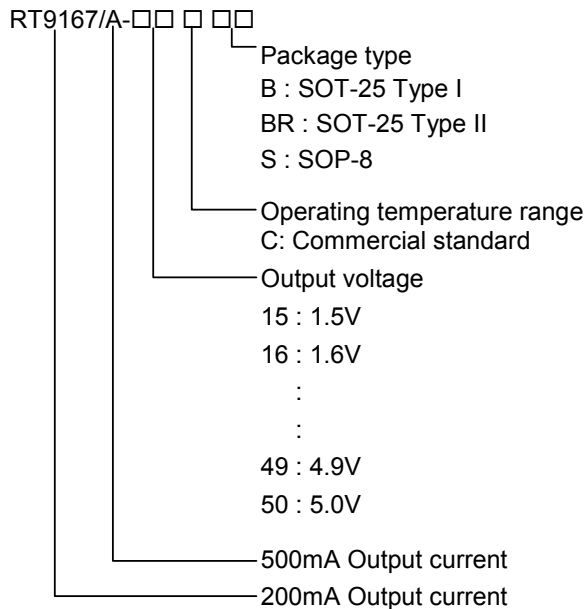

Features

- Stable with Low-ESR Output Capacitor
- Low Dropout Voltage (220mV and 200mA)
- Low Operation Current - 80μA Typical
- Shutdown Function
- Low Noise Output
- Low Temperature Coefficient
- Current and Thermal Limiting
- Custom Voltage Available
- SOT-25 and SOP-8 Packages

Applications

- Cellular Telephones
- Laptop, Notebook, and Palmtop Computers
- Battery-powered Equipment
- Hand-held Equipment

Pin Configurations

Part Number	Pin Configurations
RT9167/A-□□□CB (Plastic SOT-25)	<p>TOP VIEW</p> <p>1. IN 2. GND 3. SHDN 4. BP 5. OUT</p>
RT9167/A-□□□CBR (Plastic SOT-25)	<p>TOP VIEW</p> <p>1. OUT 2. GND 3. IN 4. SHDN 5. BP</p>
RT9167/A-□□□CS (Plastic SOP-8)	<p>TOP VIEW</p> <p>SHDN 1, 2. IN, 3. OUT, 4. BP, 5. GND, 6. GND, 7. GND, 8. GND</p>

Marking Information

Part Number	Marking
RT9167-15CB	E0
RT9167-16CB	E1
RT9167-17CB	E2
RT9167-18CB	E3
RT9167-19CB	E4
RT9167-20CB	E5
RT9167-21CB	E6
RT9167-22CB	E7
RT9167-23CB	E8
RT9167-24CB	E9
RT9167-25CB	EA
RT9167-26CB	EB
RT9167-27CB	EC
RT9167-28CB	ED
RT9167-29CB	EE
RT9167-30CB	EF
RT9167-31CB	EG
RT9167-32CB	EH
RT9167-33CB	EJ
RT9167-34CB	EK
RT9167-35CB	EL
RT9167-36CB	EM
RT9167-37CB	EN
RT9167-38CB	EP
RT9167-39CB	EQ
RT9167-40CB	ER
RT9167-41CB	ES
RT9167-42CB	ET
RT9167-43CB	EU
RT9167-44CB	EV
RT9167-45CB	EW
RT9167-46CB	EX
RT9167-47CB	EY
RT9167-48CB	EZ
RT9167-49CB	AR

Part Number	Marking
RT9167-50CB	AS
RT9167A-15CB	J0
RT9167A-16CB	J1
RT9167A-17CB	J2
RT9167A-18CB	J3
RT9167A-19CB	J4
RT9167A-20CB	J5
RT9167A-21CB	J6
RT9167A-22CB	J7
RT9167A-23CB	J8
RT9167A-24CB	J9
RT9167A-25CB	JA
RT9167A-26CB	JB
RT9167A-27CB	JC
RT9167A-28CB	JF
RT9167A-29CB	JE
RT9167A-30CB	JD
RT9167A-31CB	JG
RT9167A-32CB	JH
RT9167A-33CB	JJ
RT9167A-34CB	JK
RT9167A-35CB	JL
RT9167A-36CB	JM
RT9167A-37CB	JN
RT9167A-38CB	JP
RT9167A-39CB	JQ
RT9167A-40CB	JR
RT9167A-41CB	JS
RT9167A-42CB	JT
RT9167A-43CB	JU
RT9167A-44CB	JV
RT9167A-45CB	JW
RT9167A-46CB	JX
RT9167A-47CB	JY
RT9167A-48CB	JZ

Part Number	Marking
RT9167A-49CB	CA
RT9167A-50CB	CB
RT9167-15CBR	I0
RT9167-16CBR	I1
RT9167-17CBR	I2
RT9167-18CBR	I3
RT9167-19CBR	I4
RT9167-20CBR	I5
RT9167-21CBR	I6
RT9167-22CBR	I7
RT9167-23CBR	I8
RT9167-24CBR	I9
RT9167-25CBR	IA
RT9167-26CBR	IB
RT9167-27CBR	IC
RT9167-28CBR	ID
RT9167-29CBR	IE
RT9167-30CBR	IF
RT9167-31CBR	IG
RT9167-32CBR	IH
RT9167-33CBR	IJ
RT9167-34CBR	IK
RT9167-35CBR	IL
RT9167-36CBR	IM
RT9167-37CBR	IN
RT9167-38CBR	IP
RT9167-39CBR	IQ
RT9167-40CBR	IR
RT9167-41CBR	IS
RT9167-42CBR	IT
RT9167-43CBR	IU
RT9167-44CBR	IV
RT9167-45CBR	IW
RT9167-46CBR	IX
RT9167-47CBR	IY
RT9167-48CBR	IZ
RT9167-49CBR	CY

Part Number	Marking
RT9167-50CBR	CZ
RT9167A-15CBR	K0
RT9167A-16CBR	K1
RT9167A-17CBR	K2
RT9167A-18CBR	K3
RT9167A-19CBR	K4
RT9167A-20CBR	K5
RT9167A-21CBR	K6
RT9167A-22CBR	K7
RT9167A-23CBR	K8
RT9167A-24CBR	K9
RT9167A-25CBR	KA
RT9167A-26CBR	KB
RT9167A-27CBR	KC
RT9167A-28CBR	KD
RT9167A-29CBR	KE
RT9167A-30CBR	KF
RT9167A-31CBR	KG
RT9167A-32CBR	KH
RT9167A-33CBR	KJ
RT9167A-34CBR	KK
RT9167A-35CBR	KL
RT9167A-36CBR	KM
RT9167A-37CBR	KN
RT9167A-38CBR	KP
RT9167A-39CBR	KQ
RT9167A-40CBR	KR
RT9167A-41CBR	KS
RT9167A-42CBR	KT
RT9167A-43CBR	KU
RT9167A-44CBR	KV
RT9167A-45CBR	KW
RT9167A-46CBR	KX
RT9167A-47CBR	KY
RT9167A-48CBR	KZ
RT9167A-49CBR	CC
RT9167A-50CBR	CD

Pin Description

Pin Name	Pin Function
IN	Input
GND	Ground
$\overline{\text{SHDN}}$	Active Low Shutdown Input
BP	Reference Noise Bypass
OUT	Output

Function Block Diagram

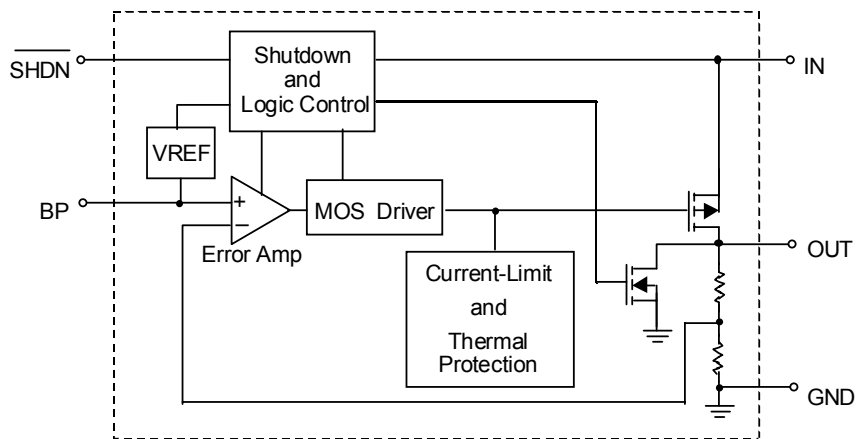

Typical Application Circuit

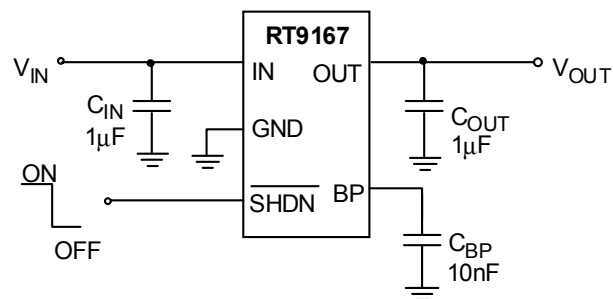

Absolute Maximum Ratings

- Input Voltage 8V
- Power Dissipation, P_D @ $T_A = 25^\circ\text{C}$
 - SOT-25 0.25W
 - SOP-8 0.625W
- Operating Junction Temperature Range -40°C to 125°C
- Storage Temperature Range -65°C to 150°C
- Package Thermal Resistance
 - SOT-25, θ_{JA} 250°C/W
 - SOP-8, θ_{JA} 160°C/W
- Lead Temperature (Soldering, 5 sec.) 260°C

Electrical Characteristics

($V_{IN} = 5.0\text{V}$, $C_{IN} = 1\mu\text{F}$, $C_{OUT} = 1\mu\text{F}$, $T_A = 25^\circ\text{C}$, unless otherwise specified)

Parameter	Symbol	Test Conditions	Min	Typ	Max	Units	
Input Voltage Range	V_{IN}		2.9	--	7	V	
		$I_L = 50\text{mA}$	2.7	--	7		
Output Voltage Accuracy	ΔV_{OUT}	$I_L = 1\text{mA}$	-2	--	+2	%	
Maximum Output Current	RT9167	I_{MAX}	200	--	--	mA	
	RT9167A		500	--	--		
Current Limit	RT9167	I_{LIMIT}	$R_{LOAD} = 1\Omega$	--	300	--	mA
	RT9167A			--	700	--	
GND Pin Current	RT9167/A	I_G	No Load	--	80	150	μA
	RT9167		$I_{OUT} = 200\text{mA}$	--	90	150	
	RT9167A		$I_{OUT} = 500\text{mA}$	--	90	150	
Dropout Voltage (Note) ($V_{OUT}(\text{Nominal}) \geq 3.0\text{V}$ Version)	RT9167/A	V_{DROP}	$I_{OUT} = 1\text{mA}$	--	1.1	5	mV
	RT9167/A		$I_{OUT} = 50\text{mA}$	--	55	100	
	RT9167/A		$I_{OUT} = 200\text{mA}$	--	220	300	
	RT9167A		$I_{OUT} = 500\text{mA}$	--	600	750	
Line Regulation	ΔV_{LINE}	$V_{IN} = (V_{OUT} + 0.15)$ to 7V , $I_{OUT} = 1\text{mA}$	-0.2	--	+0.2	%/V	
Load Regulation	RT9167	ΔV_{LOAD}	$I_{OUT} = 0\text{mA}$ to 200mA	--	0.01	0.04	%/mA
	RT9167A		$I_{OUT} = 0\text{mA}$ to 500mA	--	0.01	0.04	
SHDN Input High Threshold	V_{IH}	$V_{IN} = 3\text{V}$ to 5.5V	1.6	--	--	V	
SHDN Input Low Threshold	V_{IL}	$V_{IN} = 3\text{V}$ to 5.5V	--	--	0.4	V	
SHDN Bias Current	I_{SD}		--	--	100	nA	
Shutdown Supply Current	I_{GSD}	$V_{OUT} = 0\text{V}$	--	0.01	1	μA	
Thermal Shutdown Temperature	T_{SD}		--	155	--	$^\circ\text{C}$	
Output Noise	e_{NO}	$C_{BP} = 10\text{nF}$, $C_{OUT} = 10\mu\text{F}$	--	350	--	$\text{nV}\sqrt{\text{Hz}}$	
Ripple Rejection	PSRR	$F = 100\text{Hz}$, $C_{BP} = 10\text{nF}$, $C_{OUT} = 10\mu\text{F}$	--	58	--	dB	

Notes: Dropout voltage definition: $V_{IN} - V_{OUT}$ when V_{OUT} is 50 mV below the value of V_{OUT} at $V_{IN} = V_{OUT} + 0.5\text{V}$

Typical Operating Characteristics

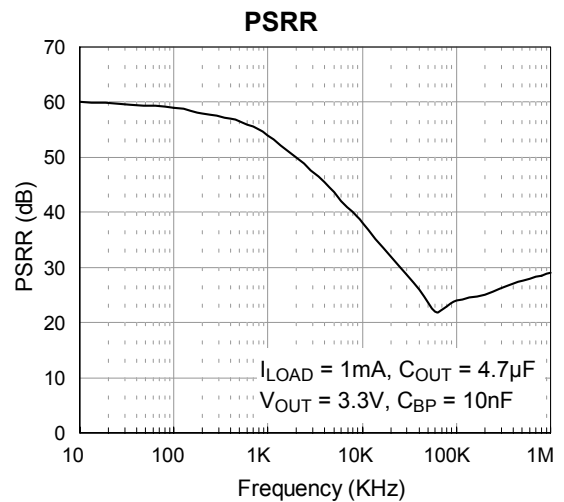
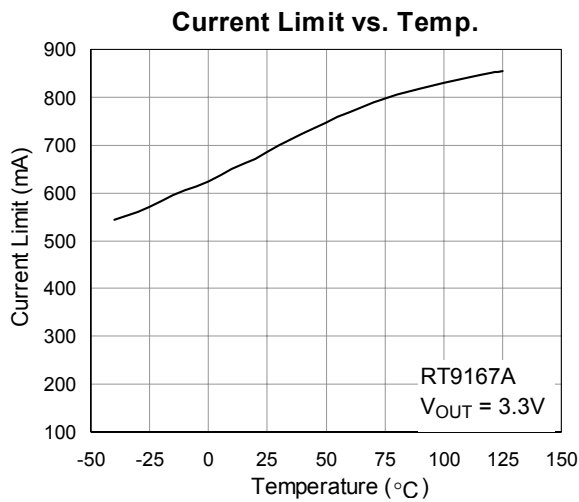
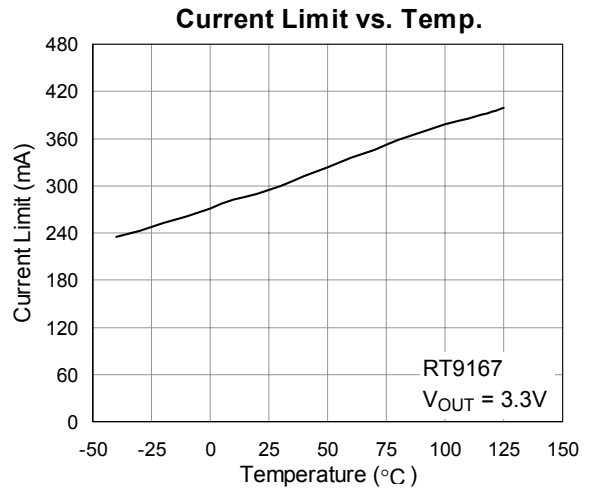
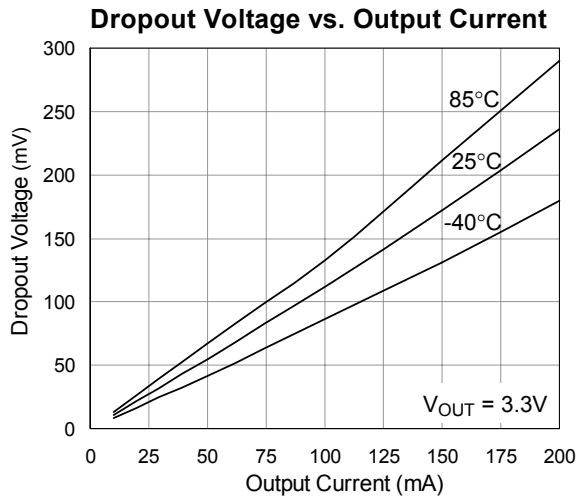
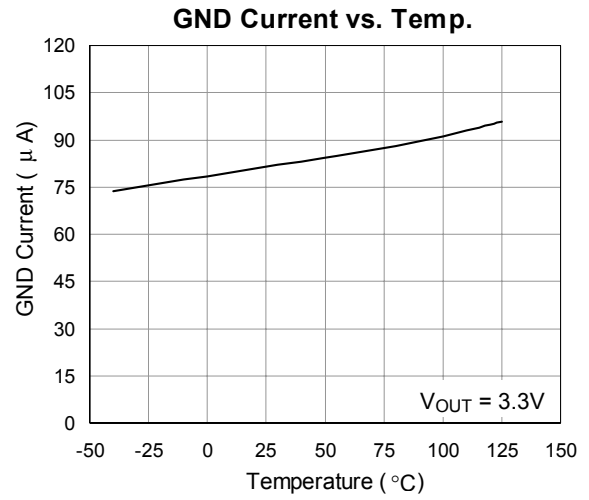
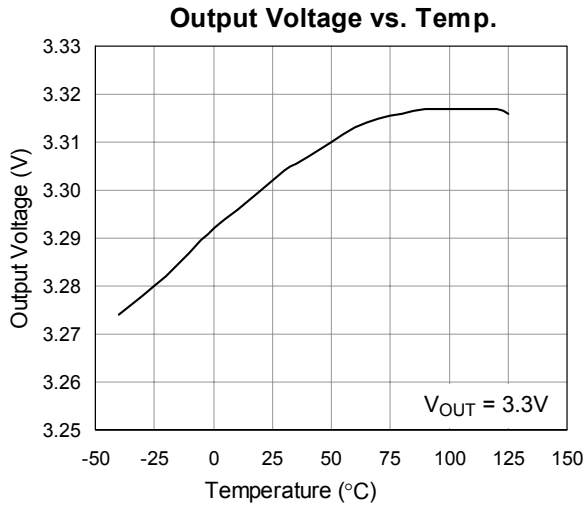

Load Transient Response

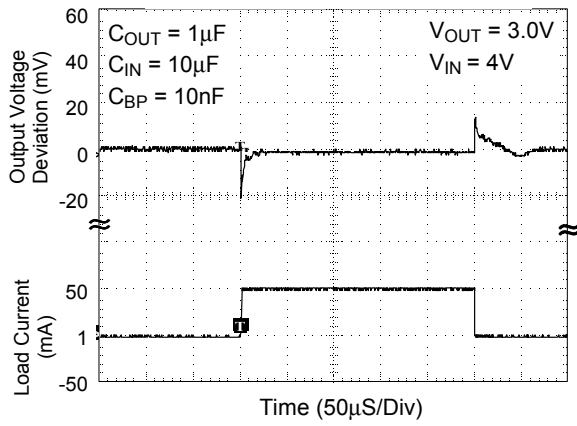

Load Transient Response

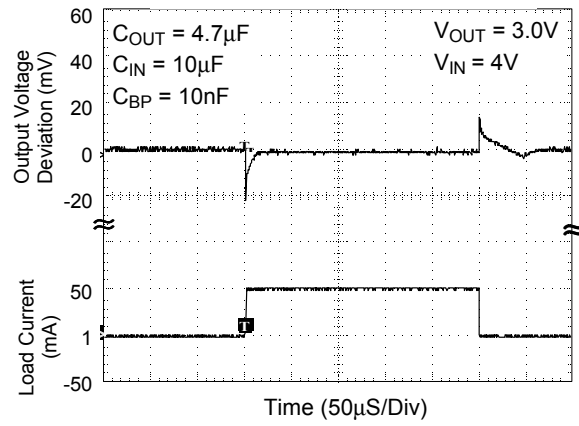

Line Transient Response

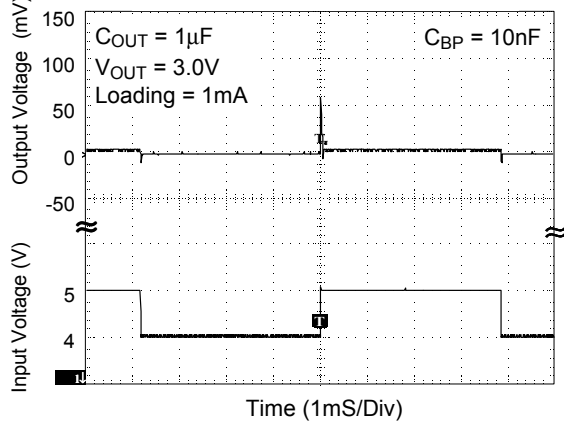

Line Transient Response

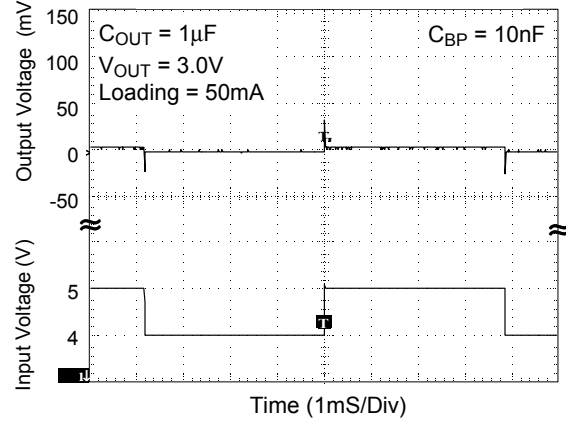

Line Transient Response

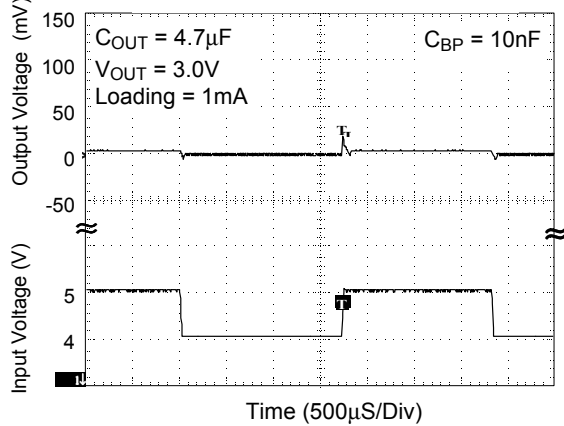

Line Transient Response

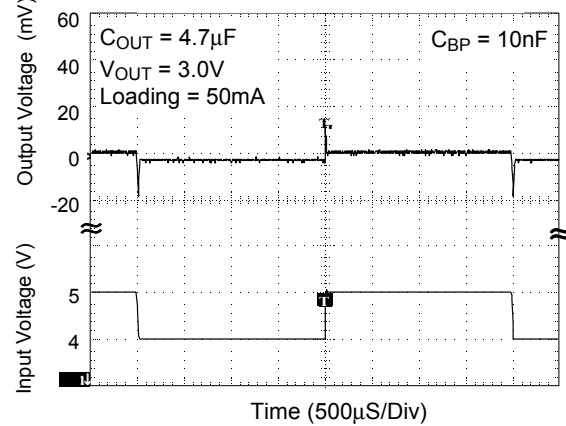

Applications Guides

Capacitor Selection and Regulator Stability

Like any low-dropout regulator, the external capacitors used with the RT9167/A must be carefully selected for regulator stability and performance.

Using a capacitor whose value is $> 1\mu\text{F}$ on the RT9167/A input and the amount of capacitance can be increased without limit. The input capacitor must be located a distance of not more than 0.5" from the input pin of the IC and returned to a clean analog ground. Any good quality ceramic or tantalum can be used for this capacitor. The capacitor with larger value and lower ESR (equivalent series resistance) provides better PSRR and line-transient response.

The output capacitor must meet both requirements for minimum amount of capacitance and ESR in all LDOs application. The RT9167/A is designed specifically to work with low ESR ceramic output capacitor in space-saving and performance consideration. Using a ceramic capacitor whose value is at least $1\mu\text{F}$ with ESR is $> 5\text{m}\Omega$ on the RT9167/A output ensures stability. The RT9167/A still works well with output capacitor of other types due to the wide stable ESR range. Fig.1 shows the curves of allowable ESR range as a function of load current for various output voltages and capacitor values. Output capacitor of larger capacitance can reduce noise and improve load-transient response, stability, and PSRR. The output capacitor should be located not more than 0.5" from the V_{OUT} pin of the RT9167/A and returned to a clean analog ground.

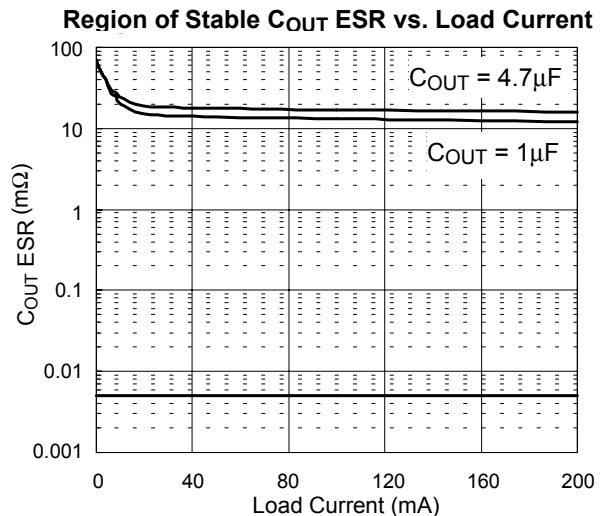

Fig. 1

Note that some ceramic dielectrics exhibit large capacitance and ESR variation with temperature. It may be necessary to use $2.2\mu\text{F}$ or more to ensure stability at temperatures below -10°C in this case. Also, tantalum capacitors, $2.2\mu\text{F}$ or more may be needed to maintain capacitance and ESR in the stable region for strict application environment.

Tantalum capacitors maybe suffer failure due to surge current when it is connected to a low-impedance source of power (like a battery or very large capacitor). If a tantalum capacitor is used at the input, it must be guaranteed to have a surge current rating sufficient for the application by the manufacture.

Use a 10nF bypass capacitor at BP for low output voltage noise. The capacitor, in conjunction with an internal $200\text{K}\Omega$ resistor, which connects bypass pin and the band-gap reference, creates an 80Hz low-pass filter for noise reduction. Increasing the capacitance will slightly decrease the output noise, but increase the start-up time. The capacitor connected to the bypass pin for noise reduction must have very low leakage. This capacitor leakage current causes the output voltage to decline by a proportional amount to the current due to the voltage drop on the internal $200\text{K}\Omega$ resistor. Fig. 2 shows the power on response.

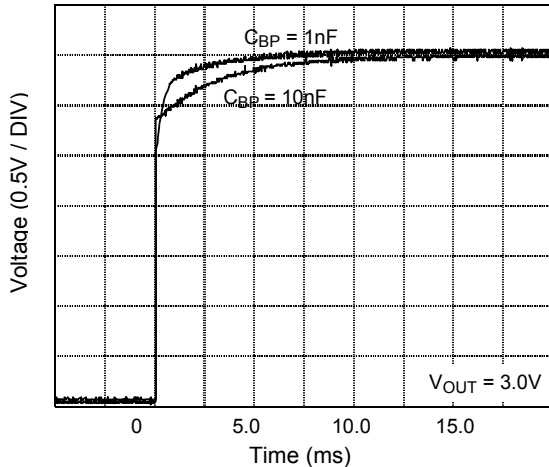

Fig. 2

Load-Transient Considerations

The RT9167/A load-transient response graphs (see Typical Operating Characteristics) show two components of the output response: a DC shift from the output impedance due to the load current change, and the transient response. The DC shift is quite small due to the excellent load regulation of the IC. Typical output voltage transient spike for a step change in the load current from 0mA to 50mA is tens mV, depending on the ESR of the output capacitor. Increasing the output capacitor’s value and decreasing the ESR attenuates the overshoot.

Shutdown Input Operation

The RT9167/A is shutdown by pulling the SHDN input low, and turned on by driving the input high. If this feature is not to be used, the SHDN input should be tied to VIN to keep the regulator on at all times (the SHDN input must **not** be left floating).

To ensure proper operation, the signal source used to drive the SHDN input must be able to swing above and below the specified turn-on/turn-off voltage thresholds which guarantee an ON or OFF state (see Electrical Characteristics). The ON/OFF signal may come from either CMOS output, or an open-collector output with pull-up resistor to the RT9167/A input voltage or another logic supply. The high-level voltage may exceed the RT9167/A input voltage, but must remain within the absolute maximum ratings for the SHDN pin.

Internal P-Channel Pass Transistor

The RT9167/A features a typical 1.1Ω P-channel MOSFET pass transistor. It provides several advantages over similar designs using PNP pass transistors, including longer battery life. The P-channel MOSFET requires no base drive, which reduces quiescent current considerably. PNP-based regulators waste considerable current in dropout when the pass transistor saturates. They also use high base-drive currents under large loads. The RT9167/A does not suffer from these problems and consume only 80μA of quiescent current whether in dropout, light-load, or heavy-load applications.

Input-Output (Dropout) Voltage

A regulator’s minimum input-output voltage differential (or dropout voltage) determines the lowest usable supply voltage. In battery-powered systems, this will determine the useful end-of-life battery voltage. Because the RT9167/A uses a P-channel MOSFET pass transistor, the dropout voltage is a function of drain-to-source on-resistance [R_{DS(ON)}] multiplied by the load current.

Reverse Current Path

The power transistor used in the RT9167/A has an inherent diode connected between the regulator input and output (see Fig.3). If the output is forced above the input by more than a diode-drop, this diode will become forward biased and current will flow from the V_{OUT} terminal to V_{IN}. This diode will also be turned on by abruptly stepping the input voltage to a value below the output voltage. To prevent regulator mis-operation, a Schottky diode should be used in any applications where input/output voltage conditions can cause the internal diode to be turned on (see Fig.4). As shown, the Schottky diode is connected in parallel with the internal parasitic diode and prevents it from being turned on by limiting the voltage drop across it to about 0.3V. < 100 mA to prevent damage to the part.

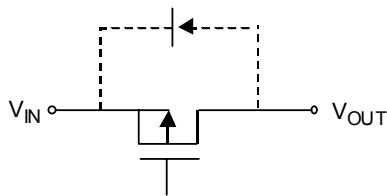

Fig. 3

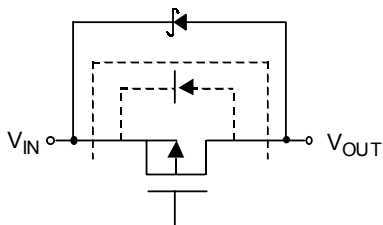

Fig. 4

Current Limit and Thermal Protection

The RT9167 includes a current limit which monitors and controls the pass transistor's gate voltage limiting the output current to 300mA Typ. (700mA Typ. for RT9167A). Thermal-overload protection limits total power dissipation in the RT9167/A. When the junction temperature exceeds $T_J = +155^\circ\text{C}$, the thermal sensor signals the shutdown logic turning off the pass transistor and allowing the IC to cool. The thermal sensor will turn the pass transistor on again after the IC's junction temperature cools by 10°C , resulting in a pulsed output during continuous thermal-overload conditions. Thermal-overloaded protection is designed to protect the RT9167/A in the event of fault conditions. Do not exceed the absolute maximum junction-temperature rating of $T_J = +150^\circ\text{C}$ for continuous operation. The output can be shorted to ground for an indefinite amount of time without damaging the part by cooperation of current limit and thermal protection.

Operating Region and Power Dissipation

The maximum power dissipation of RT9167/A depends on the thermal resistance of the case and circuit board, the temperature difference between the die junction and ambient air, and the rate of airflow. The power dissipation across the device is $P = I_{OUT}(V_{IN} - V_{OUT})$. The maximum power dissipation is:

$$P_{MAX} = (T_J - T_A) / \theta_{JA}$$

where $T_J - T_A$ is the temperature difference between the RT9167/A die junction and the surrounding environment, θ_{JA} is the thermal resistance from the junction to the surrounding environment. The GND pin of the RT9167/A performs the dual function of providing an electrical connection to ground and channeling heat away. Connect the GND pin to ground using a large pad or ground plane.

Package Information

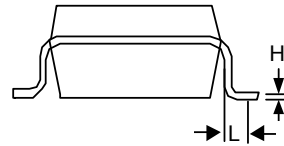
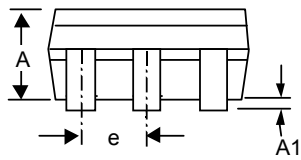
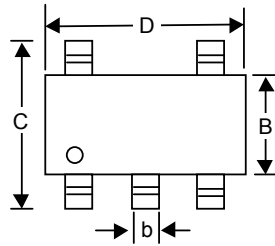

Symbol	Dimensions In Millimeters		Dimensions In Inches	
	Min	Max	Min	Max
A	0.889	1.295	0.035	0.051
A1	0.000	0.152	0.000	0.006
B	1.397	1.803	0.055	0.071
b	0.356	0.559	0.014	0.022
C	2.591	2.997	0.102	0.118
D	2.692	3.099	0.106	0.122
e	0.838	1.041	0.033	0.041
H	0.102	0.254	0.004	0.010
L	0.356	0.610	0.014	0.024

SOT- 25 Surface Mount Package

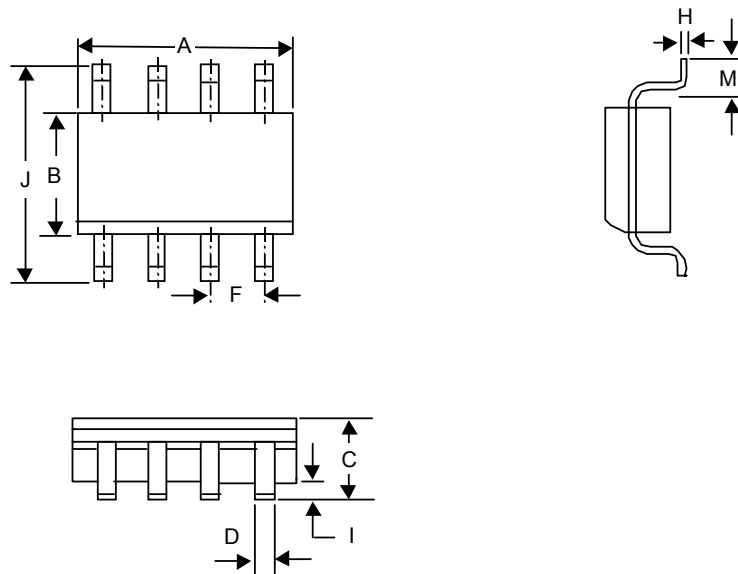

Symbol	Dimensions In Millimeters		Dimensions In Inches	
	Min	Max	Min	Max
A	4.801	5.004	0.189	0.197
B	3.810	3.988	0.150	0.157
C	1.346	1.753	0.053	0.069
D	0.330	0.508	0.013	0.020
F	1.194	1.346	0.047	0.053
H	0.178	0.254	0.007	0.010
I	0.102	0.254	0.004	0.010
J	5.791	6.198	0.228	0.244
M	0.406	1.270	0.016	0.050

8-Lead SOP Plastic Package

RICHTEK TECHNOLOGY CORP.

Headquarter

6F, No. 35, Hsintai Road, Chupei City

Hsinchu, Taiwan, R.O.C.

Tel: (8863)5510047 Fax: (8863)5537749

RICHTEK TECHNOLOGY CORP.

Taipei Office (Marketing)

8F-1, No. 137, Lane 235, Paochiao Road, Hsintien City

Taipei County, Taiwan, R.O.C.

Tel: (8862)89191466 Fax: (8862)89191465

Email: marketing@richtek-ic.com.tw