



1 Form A/1 Form B  
Solid State Relay

## DESCRIPTION

The AD4C213 is composed of two isolated relays; one normally open and one normally closed. Each relay has a bi-directional, single-pole, single-throw contact. Completely independent of its counterpart, each consists of an LED driver that activates an integrated circuit, which in turn drives a pair of DMOS transistors. These transistors are protected with free-wheeling diodes that can handle up to 1.5A of inrush current, making the relay ideal for switching lamps and highly inductive loads.

## FEATURES

- High input-to-output isolation
- Low input control power consumption
- 150mA maximum continuous load current
- 25 ohms maximum on-resistance (Form A)
- 25 ohms maximum on-resistance (Form B)
- Long life/high reliability

## APPLICATIONS

- Telecom switching
- Tip/Ring control
- PCMCIA modules
- Multiplexers
- Meter reading systems
- Data acquisition
- Medical equipment
- Battery monitoring
- Home/Safety security systems

## OPTIONS/SUFFIXES

- -S Surface Mount Option
- -TR Tape and Reel

## SCHEMATIC DIAGRAM

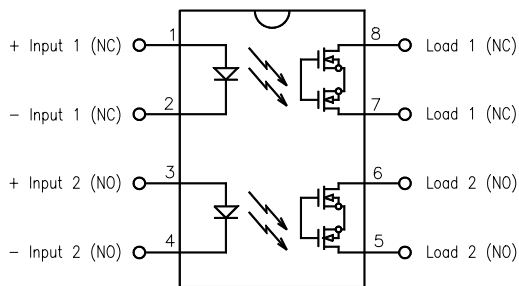

## MAXIMUM RATINGS

PARAMETER	UNIT	MIN	TYP	MAX
Storage Temperature	°C	-55		125
Operating Temperature	°C	-40		85
Continuous Input Current	mA			40
Transient Input Current	mA			400
Reverse Input Control Voltage	V	6		
Output Power Dissipation	mW			500

## APPROVALS

- BAPT CERTIFICATE #607836:  
BS EN 60950, BS EN 41003, BS EN 60065
- CSA CERTIFICATE #LR111581-1
- UL FILE #E90096



**ELECTRICAL CHARACTERISTICS - 25°**

PARAMETER	UNIT	MIN	TYP	MAX	TEST CONDITIONS
<b>INPUT SPECIFICATIONS</b>					
LED Forward Voltage	V		1.2	1.5	If = 10mA
LED Reverse Voltage	V	6	12		Ir = 10uA
Turn-On Current (Form A)	m A		2.5	5	Io = 150mA
Turn-On Current (Form B)	m A		0.5		Io = 150mA
Turn-Off Current (Form A)	m A		0.5		
Turn-Off Current (Form B)	m A		2.5		
<b>OUTPUT SPECIFICATIONS (NORMALLY OPEN)</b>					
Blocking Voltage	V	400			10uA
Continuous Load Current	m A			150	If = 5mA
On-Resistance	Ω		20	25	
Leakage Current	μ A		0.2	10	Vo = 400V
Output Capacitance	p F		25	50	Vo = 25V, f = 1.0MHz
Offset Voltage	m V			0.2	If = 5mA
Turn-On Time	m s		0.5	1	If = 5mA, Io = 150mA
Turn-Off Time	m s		0.1	0.5	If = 5mA, Io = 150mA
<b>OUTPUT SPECIFICATIONS (NORMALLY CLOSED)</b>					
Blocking Voltage	V	400			Io = 10mA, If = 5mA
Continuous Load Current	m A			150	If = 0mA
On-Resistance	Ω		20	25	Io = 150mA
Leakage Current	μ A		0.2	10	Vo = 400V, If = 5mA
Output Capacitance	p F		15	20	Vo = 25V, f = 1.0MHz
Offset Voltage	m V			0.2	
Turn-On Time	m s		0.2	1	If = 0mA, Io = 150mA
Turn-Off Time	m s		0.5	1	If = 5mA, Io = 150mA
<b>COUPLED SPECIFICATIONS</b>					
Isolation Voltage	V	2500			T = 1 minute
-H Suffix	V	3750			T = 1 minute
Isolation Resistance	G Ω	100			
Coupled Capacitance	p F			2	
Contact Transient Ratio	V / μ s	2000	7000		dV = 50V

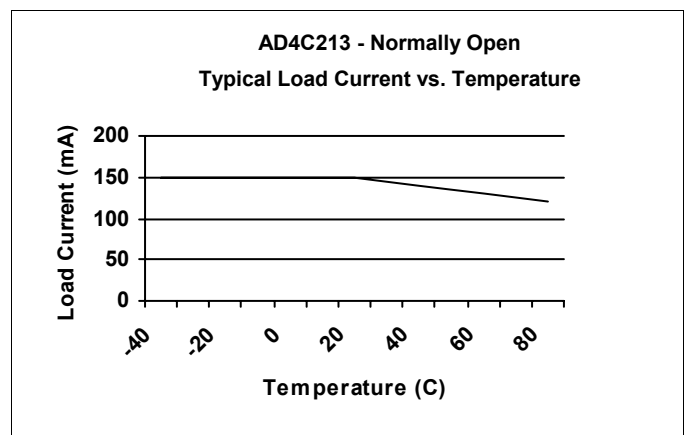
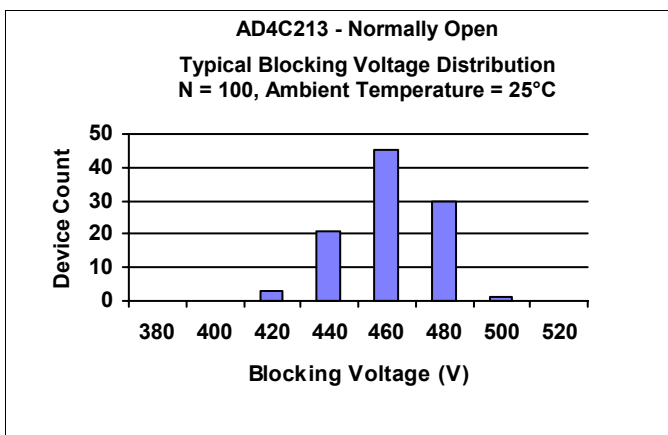
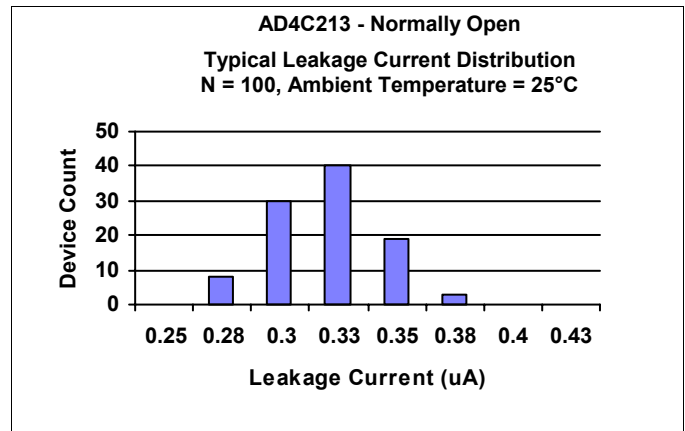
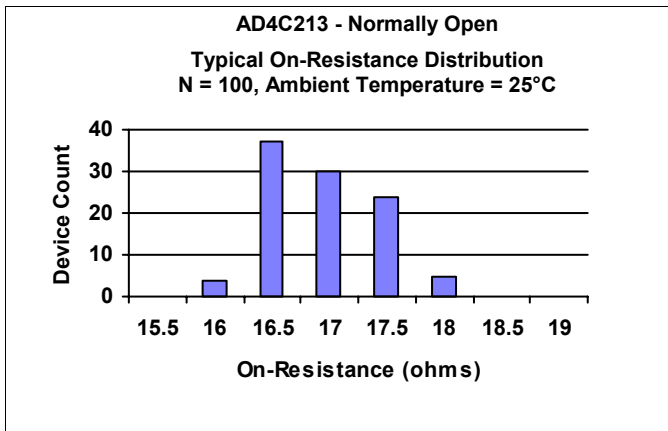
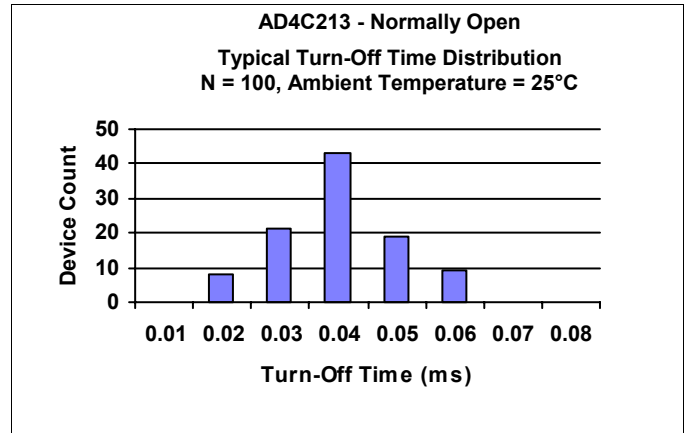
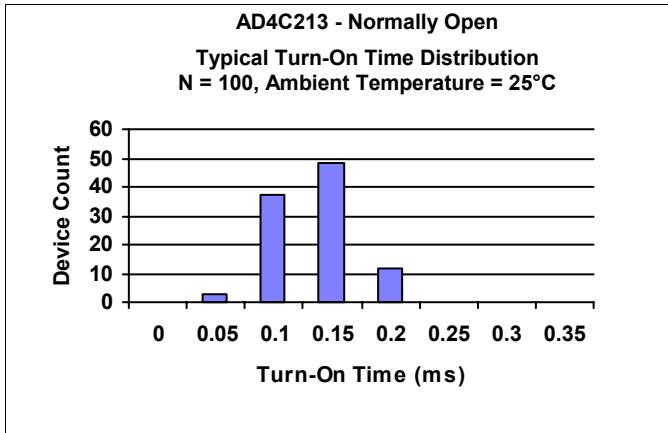

**PERFORMANCE DATA**

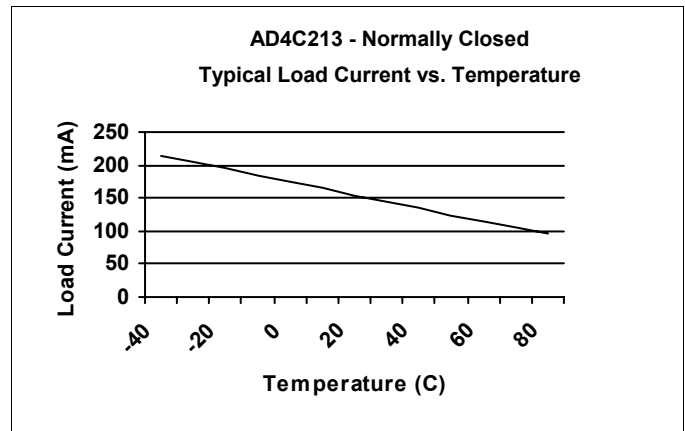
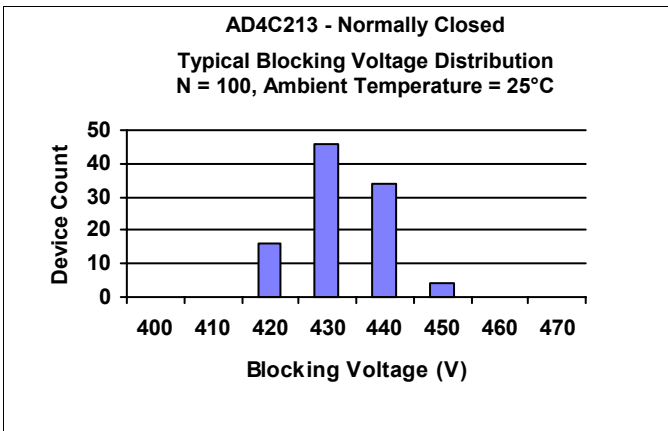
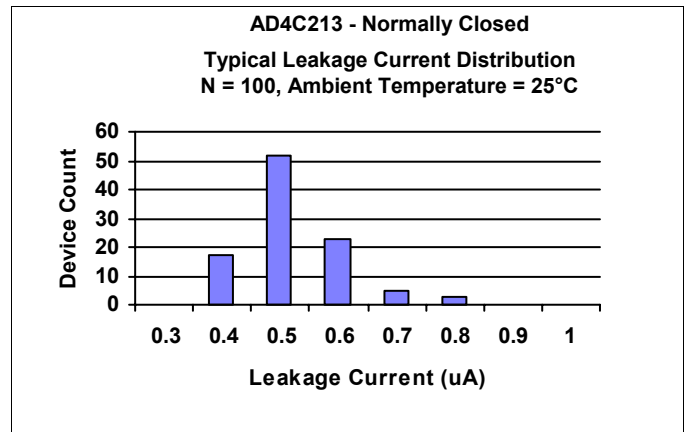
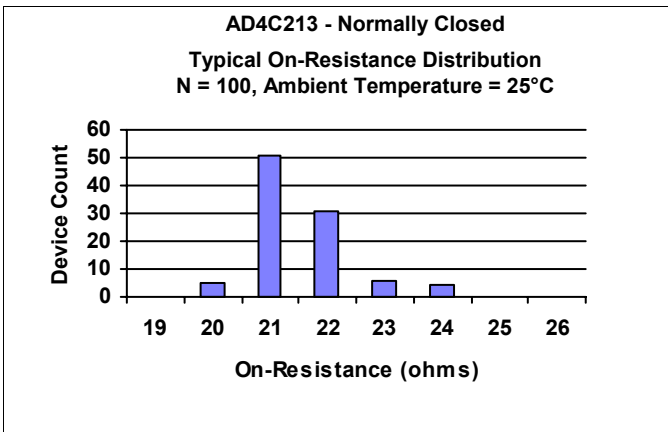
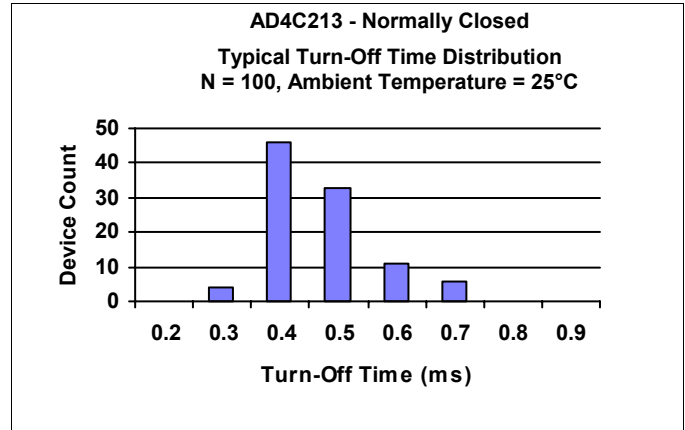
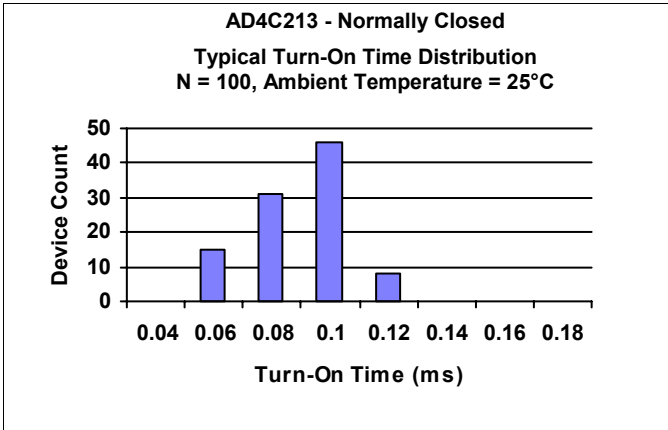





1 Form A/1 Form B  
Solid State Relay

**MECHANICAL DIMENSIONS**

**8 PIN DUAL IN-LINE PACKAGE**

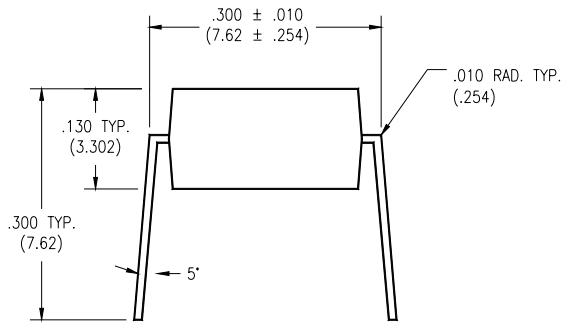

**END VIEW**

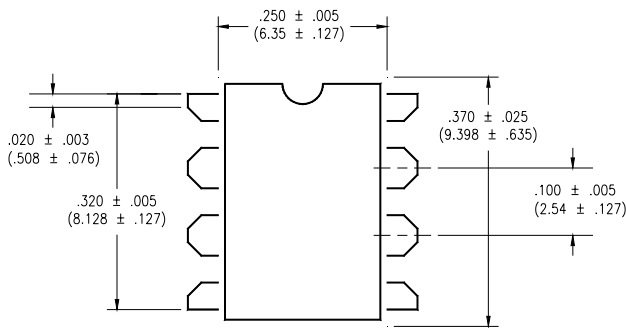

**TOP VIEW**

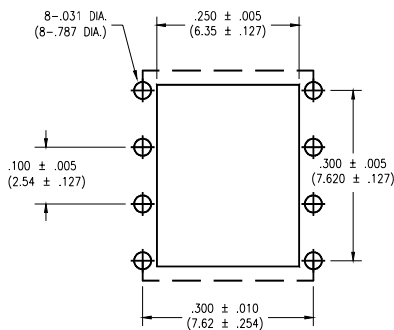

**BOTTOM VIEW/  
BOARD PATTERN**

**8 PIN SURFACE MOUNT DEVICE**

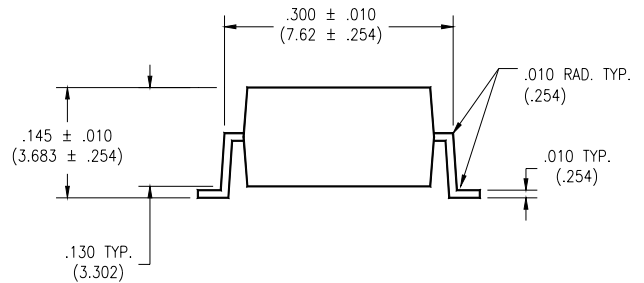

**END VIEW**

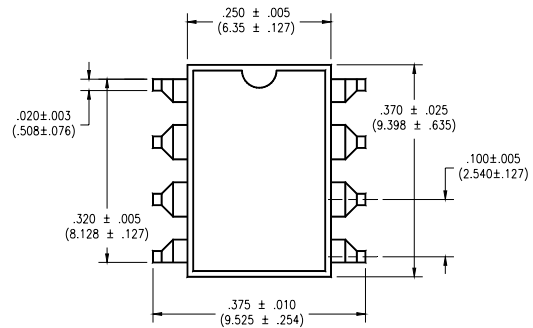

**TOP VIEW**

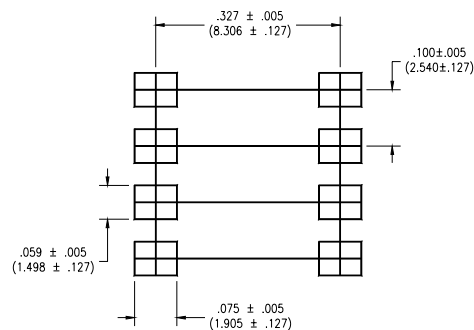

**BOTTOM VIEW/  
BOARD PATTERN**