



## DESCRIPTION

The AD4C211 is a bi-directional, double-pole, single-throw, normally open multipurpose solid-state relay. It is designed to replace electromechanical relays in general purpose switching applications. The relay consists of two integrated circuits, each driving a pair of rugged source-to-source enhancement type DMOS transistors. Each integrated circuit is optically coupled to a light emitting diode. The output MOS transistors are protected with free-wheeling diodes that can handle up to 1.5A of inrush current, making the relay ideal for switching lamps and highly inductive loads.

## FEATURES

- Low input control power consumption (2.5mA TYP)
- 150mA maximum continuous load current
- 20 ohms maximum on-resistance
- High input-to-output isolation
- Long life/high reliability

## OPTIONS/SUFFIXES\*

- -S Surface Mount Option
- -TR Tape and Reel Option

NOTE: Suffixes listed above are not included in marking on device for part number identification.

## SCHEMATIC DIAGRAM

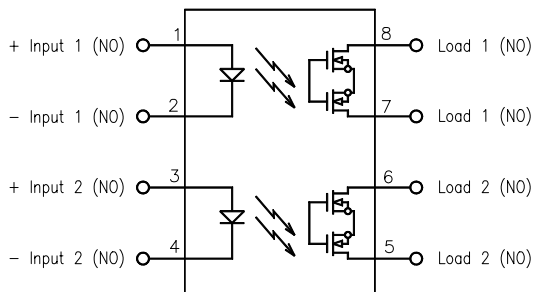

## APPLICATIONS

- Reed relay replacement
- Meter reading systems
- Medical equipment
- Battery monitoring
- Multiplexers

## ABSOLUTE MAXIMUM RATINGS\*

PARAMETER	UNIT	MIN	TYP	MAX
Storage Temperature	°C	-55		125
Operating Temperature	°C	-40		85
Continuous Input Current	mA			40
Transient Input Current	mA			400
Reverse Input Control Voltage	V	6		
Output Power Dissipation	mW			800

\*The values indicated are absolute stress ratings. Functional operation of the device is not implied at these or any conditions in excess of those defined in electrical characteristics section of this document. Exposure to Absolute Ratings may cause permanent damage to the device and may adversely affect reliability.

## APPROVALS

- BAPT CERTIFICATE #607836:  
BS EN 60950, BS EN 41003, BS EN 60065
- CSA CERTIFICATE #LR111581-1
- UL FILE #E90096

**ELECTRICAL CHARACTERISTICS - 25°C**

PARAMETER	UNIT	MIN	TYP	MAX	TEST CONDITIONS
<b>INPUT SPECIFICATIONS</b>					
LED Forward Voltage	V		1.2	1.5	If = 10mA
LED Reverse Voltage	V	6	12		Ir = 10uA
Turn-On Current	m A		2.5	5	Io = 150mA
Turn-Off Current	m A		0.5		
<b>OUTPUT SPECIFICATIONS</b>					
Blocking Voltage	V	400			Io = 1uA
Continuous Load Current	m A			150	If = 5mA
On-Resistance	Ω		15	20	Io = 150mA
Leakage Current	μ A		0.7	1	Vo = 400V
Output Capacitance	p F		25	50	Vo = 25V, f = 1.0MHz
Offset Voltage	m V			0.2	If = 5mA
<b>COUPLED SPECIFICATIONS</b>					
Isolation Voltage	V	2500			T = 1 minute
-H Suffix	V	3750			T = 1 minute
Turn-On Time	m s		0.5	2	If = 5mA, Io = 150mA
Turn-Off Time	m s		0.05	1	If = 5mA, Io = 150mA
Isolation Resistance	G Ω	100			
Coupled Capacitance	p F		2		
Contact Transient Ratio	V / μ s	2000	7000		dV = 50V

**PERFORMANCE DATA**

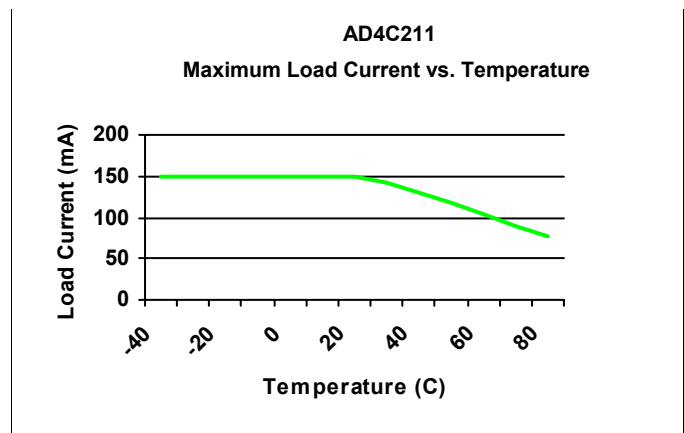
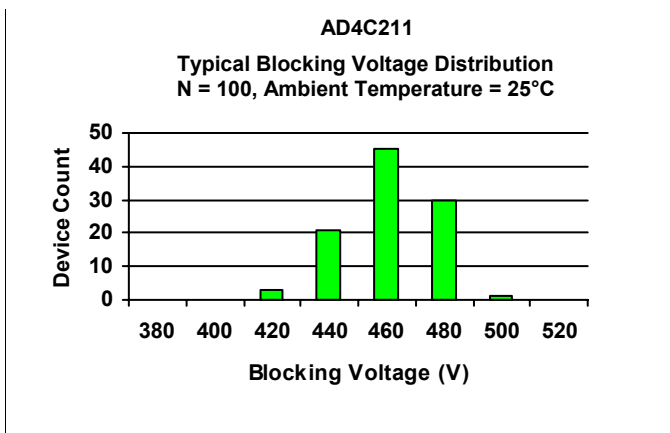
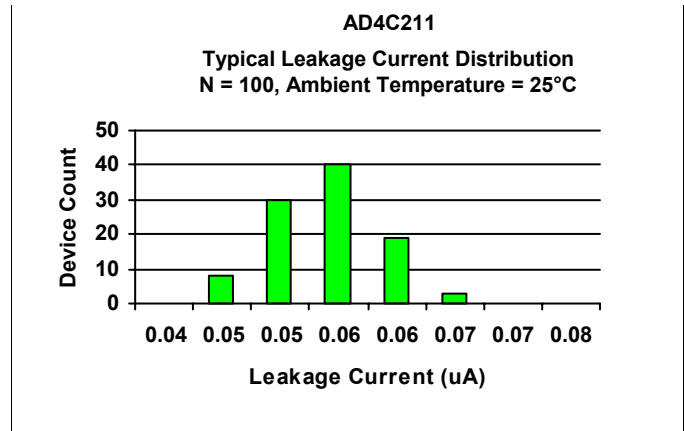
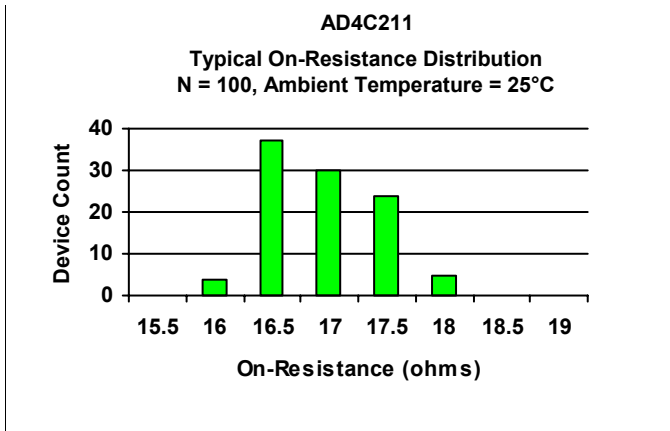
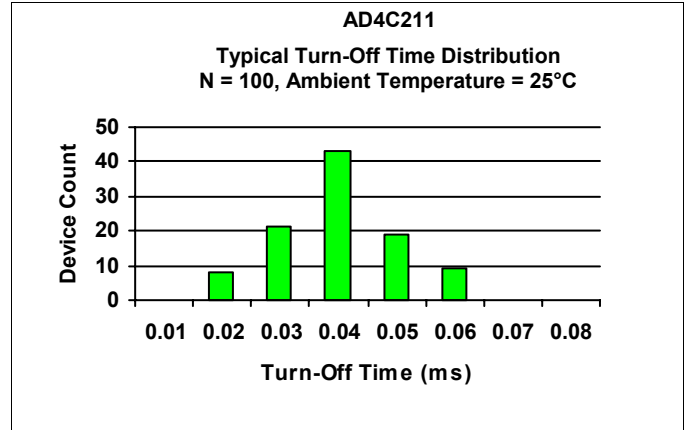
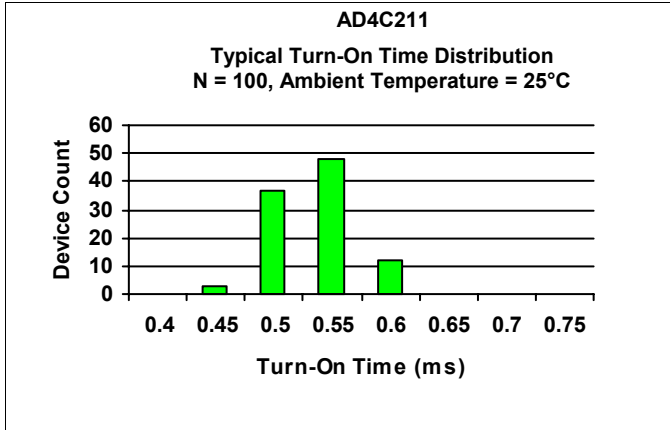

**MECHANICAL DIMENSIONS**

**8 PIN DUAL IN-LINE PACKAGE**

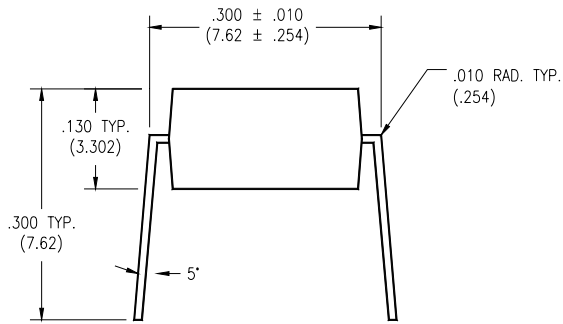

**END VIEW**

**8 PIN SURFACE MOUNT DEVICE**

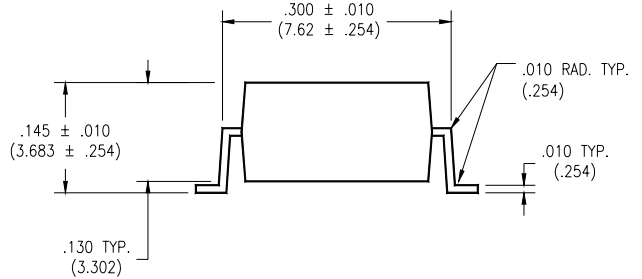

**END VIEW**

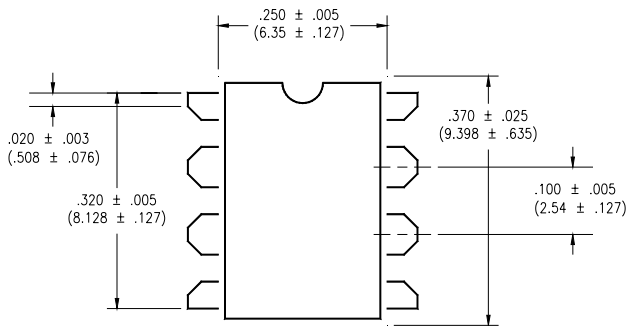

**TOP VIEW**

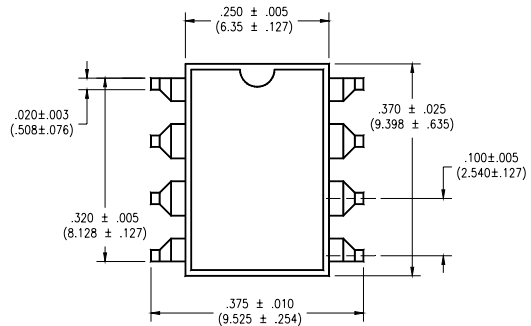

**TOP VIEW**

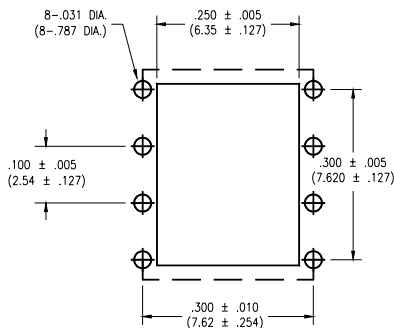

**BOTTOM VIEW/  
BOARD PATTERN**

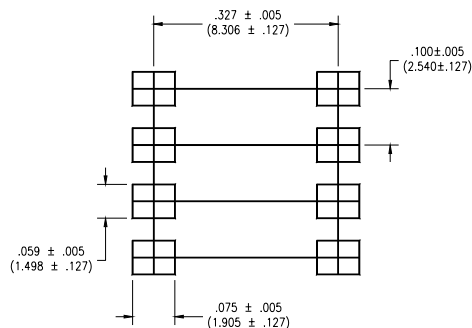

**BOTTOM VIEW/  
BOARD PATTERN**

## **DISCLAIMER**

---

*Solid State Optronics (SSO) makes no warranties or representations with regards to the completeness and accuracy of this document. SSO reserves the right to make changes to product description, specifications at any time without further notice. SSO shall not assume any liability arising out of the application or use of any product or circuit described herein. Neither circuit patent licenses nor indemnity are expressed or implied. Except as specified in SSO's Standard Terms & Conditions, SSO disclaims liability for consequential or other damage, and we make no other warranty, expressed or implied, including merchantability and fitness for particular use.*

## **LIFE SUPPORT POLICY**

---

*SSO does not authorize use of its devices in life support applications wherein failure or malfunction of a device may lead to personal injury or death. Users of SSO devices in life support applications assume all risks of such use and agree to indemnify SSO against any and all damages resulting from such use. Life support devices are defined as devices or systems which, (a) are intended for surgical implant into the body, or (b) support or sustain life, and (c) whose failure to perform when used properly in accordance with instructions for use can be reasonably expected to result in significant injury to the user, or (d) a critical component in any component of a life support device or system whose failure can be reasonably expected to cause failure of the life support device or system, or to affect its safety or effectiveness.*