

M/A-COM Voltage Variable Absorptive Attenuator

40 dB, 0.5—3.0 GHz

Features

- Single Positive Voltage Control 0 to +5 Volts
- 40 dB Attenuation Range at 900 MHz GHz
- ± 2 dB Linearity from BSL
- Low DC Power Consumption
- Low-Cost SOIC-8 Plastic Package
- Tape and Reel Packaging Available

Description

M/A-COM's AT-108 is a GaAs, MESFET MMIC voltage variable absorptive attenuator in a low cost SOIC-8 lead surface mount plastic package. The AT-108 is ideally suited for use where linear attenuation fine tuning and very low power consumption are required. Typical applications include radio, cellular, GPS equipment and automatic gain/level control circuits.

The AT-108 is fabricated with a monolithic GaAs MMIC using a mature 1-micron process. The process features full chip passivation for increased performance and reliability.

SOIC-8¹

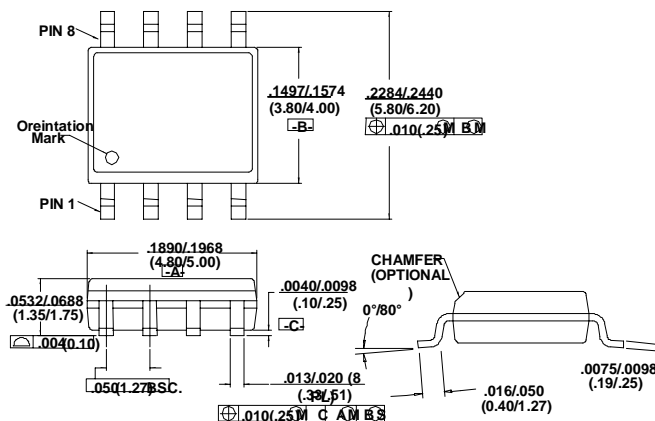

1. Dimensions are in inches/mm.

Ordering Information

Part Number	Package
AT-108	SOIC-8 Lead Plastic Package
AT-108TR	Forward Tape and Reel ¹
AT-108RTR	Reverse Tape and Reel ¹

1. If specific reel size is required, consult factory for part number assignment.

Electrical Specifications: $T_A = 25^\circ\text{C}$ ¹

Parameter	Test Conditions ¹	Units	Min.	Typ.	Max.
Insertion Loss	0.5 - 1.0 GHz	dB		2.5	2.7
	1.0 - 3.0 GHz	dB		3.2	3.5
Attenuation	0.5 - 1.0 GHz	dB	40		
	1.0 - 2.0 GHz	dB	35		
	2.0 - 3.0 GHz	dB	28		
Flatness (Peak-to-Peak)	0.5 - 1.0 GHz	dB		± 0.5	± 0.8
	1.0 - 2.0 GHz	dB		± 1.2	± 1.5
	2.0 - 3.0 GHz	dB		± 1.5	± 1.8
VSWR	0.5 - 3.0 GHz			2:1	
$T_{\text{rise}}, T_{\text{fall}}$	10% to 90% RF, 90% to 10% RF	μs		15	
$T_{\text{on}}, T_{\text{off}}$	50% Control to 90% RF, Control to 10% RF	μs		25	
Transients	In-band	mV		12	

1. All measurements in a 50 Ω system.

Specifications subject to change without notice.

- North America: Tel. (800) 366-2266, Fax (800) 618-8883
- Asia/Pacific: Tel. +81-44-844-8296, Fax +81-44-844-8298
- Europe: Tel. +44 (1344) 869 595, Fax +44 (1344) 300 020

Visit www.macom.com for additional data sheets and product information.

tyco / Electronics

M/A-COM

Absolute Maximum Ratings¹

Parameter	Absolute Maximum
Maximum Input Power	+21 dBm
Supply Voltage V_{CC}	-1V, +8V
Control Voltage V_C	-1V, $V_{CC} + 0.5V$
Operating Temperature	-40°C to +85°C
Storage Temperature	-65°C to +150°C

1. Operation of this device above any one of these parameters may cause permanent damage.

Functional Schematic

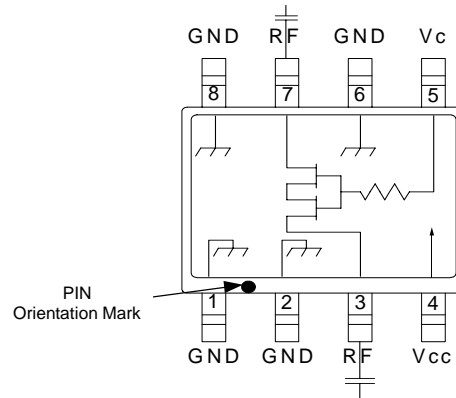

- $V_{CC} = +5 V_{DC}$ @ 50 μA max.
- $V_C = 0 V_{DC}$ to +5 V_{DC} @ 50 μA max.
- External DC blocking capacitors are required on all RF ports. 39pF used for data measurements.

Typical Performance Curves

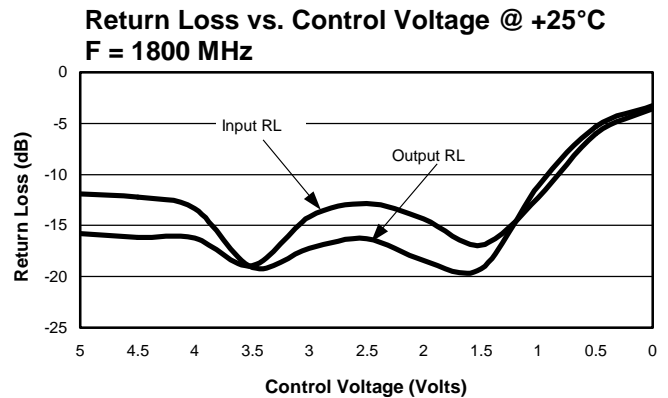
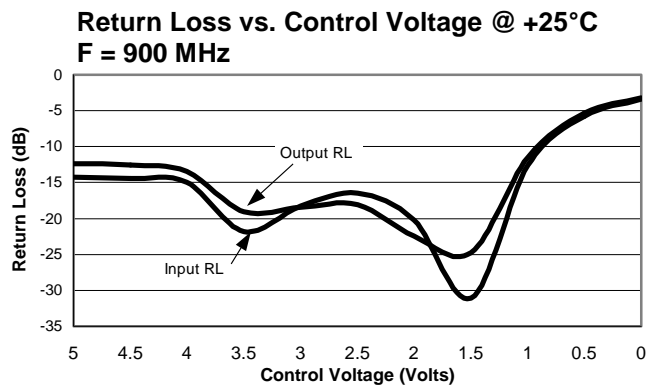
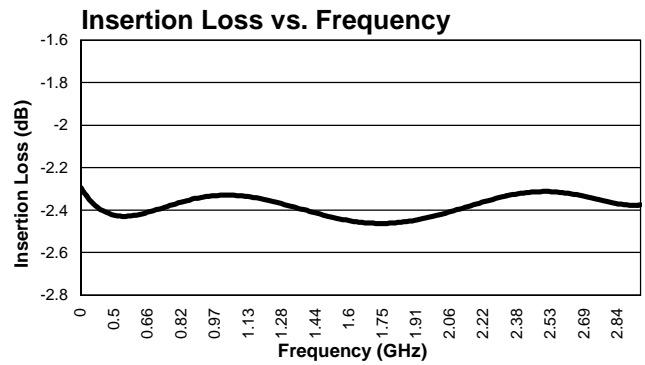
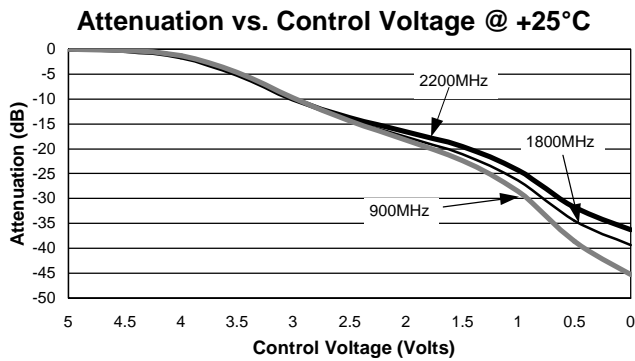

Specifications subject to change without notice.

V 4.0

North America: Tel. (800) 366-2266, Fax (800) 618-8883
Asia/Pacific: Tel.+81-44-844-8296, Fax +81-44-844-8298
Europe: Tel. +44 (1344) 869 595, Fax+44 (1344) 300 020

Visit www.macom.com for additional data sheets and product information.



Typical Performance Curves (Cont'd)

Return Loss vs. Control Voltage @ +25°C
F = 2200 MHz

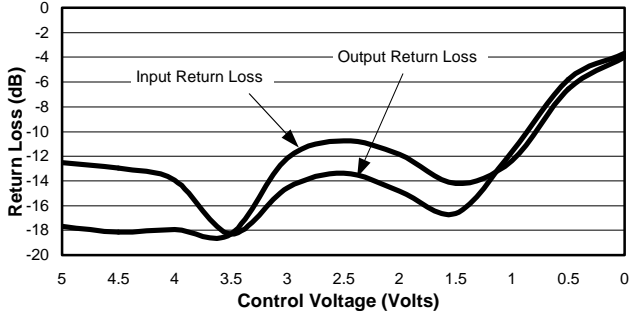

Attenuation vs. Control Voltage Typical
Device Deviation f = 900 MHz @ +25°C

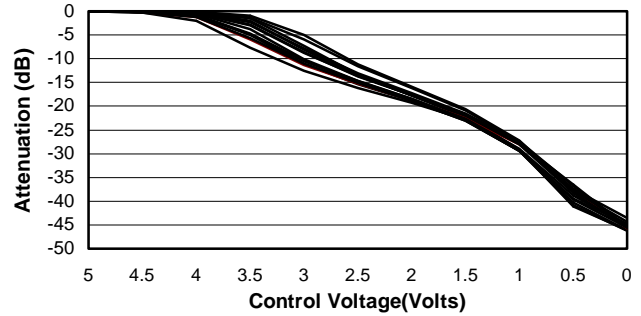

Maximum Attenuation vs. Frequency

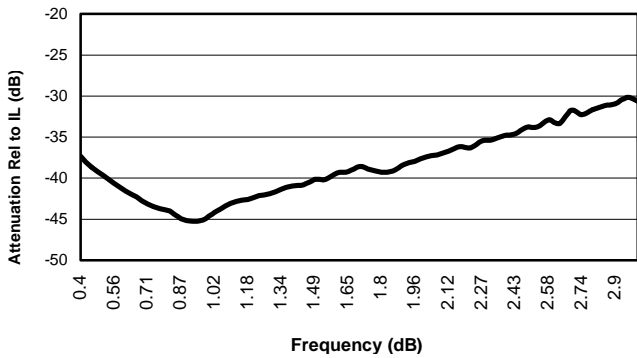

Attenuation vs. Control Voltage Typical
Device Deviation F = 1800 MHz @ +25°C

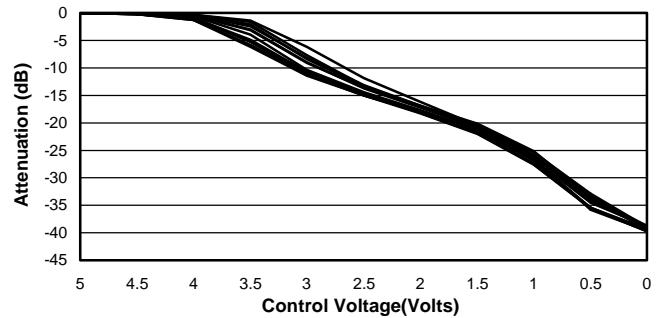

Attenuation vs. Control Voltage Typical
Device Deviations F = 2200 MHz @ +25°C

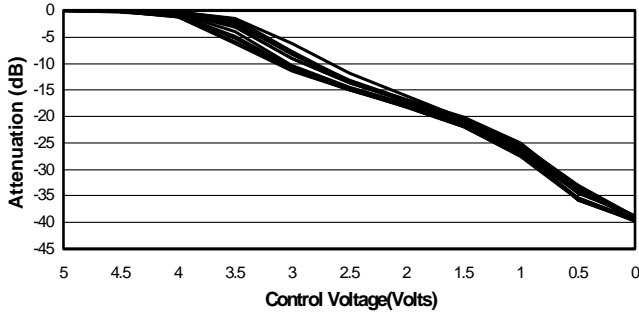

Attenuation vs. Temperature,
Normalized to +25°C, F=900 MHz

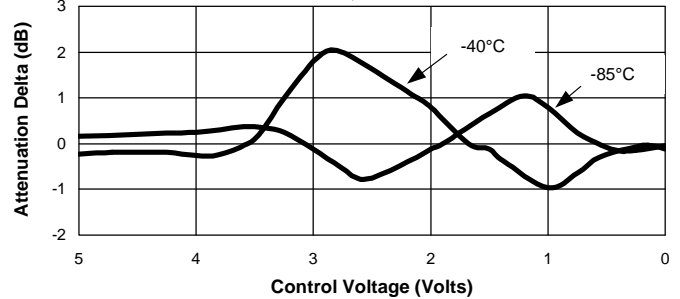

1 dB Compression vs. Control Voltage
@ +25°C, F = 900 MHz

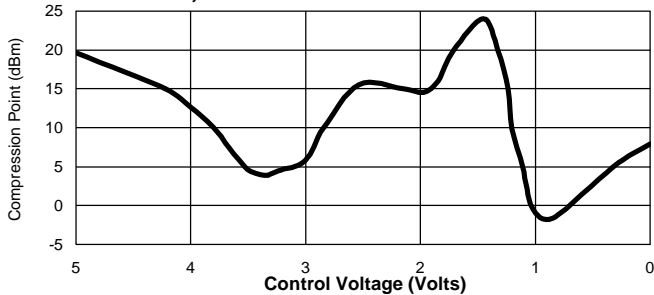

IP₃ vs. Control Voltage

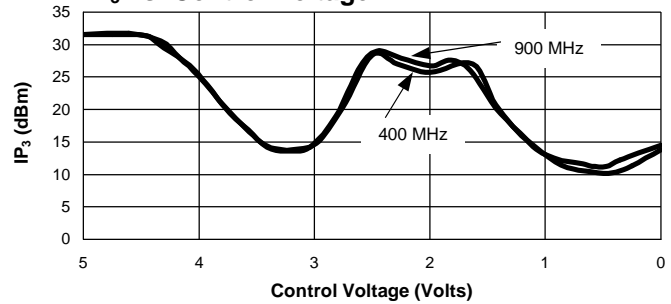

Specifications subject to change without notice.

V 4.0

- North America: Tel. (800) 366-2266, Fax (800) 618-8883
- Asia/Pacific: Tel.+81-44-844-8296, Fax +81-44-844-8298
- Europe: Tel. +44 (1344) 869 595, Fax+44 (1344) 300 020

Visit www.macom.com for additional data sheets and product information.

