

DUAL OPERATIONAL AMPLIFIER

■ GENERAL DESCRIPTION

NJM 2115 is a low operating Voltage (± 1.0 V min.) and low saturation output voltage (± 2.0 V p-p at supply voltage ± 2.5 V) operational amplifier. It is applicable to HANDY TYPE CD, RADIO CASSETE CD, and PORTABLE DAT, that are digital audio apparatus which require the 5V single supply operation and high output voltage. The NJM2115 is improved version of the NJM2100 about BIAS-CIRCUIT. So, NJM2115 is low saturation compared to the NJM2100 under the condition of low supply voltage ($< \pm 2.5$ V). The NJM2115 is stable about the oscillation compared to the NJM2100 under the condition of $V^+/V^- > 2.5$ V.

■ FEATURES

- Operating Voltage (± 1 V \sim ± 7 V)
- Low Saturation Output Voltage (± 2.0 V_{P-P} @ $V^+ = \pm 2.5$ V)
- Slew Rate (4 V/ μ s typ.)
- Unity Gain Bandwidth (12 MHz typ.)
- Package Outline DIP8, DMP8, SIP8, SSOP8
- Bipolar Technology

■ PACKAGE OUTLINE

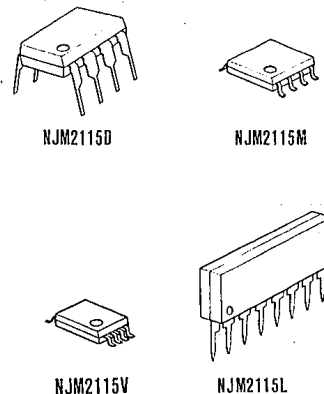

■ PIN CONFIGURATION

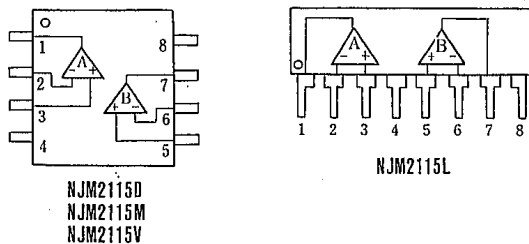

- PIN FUNCTION
1. A OUTPUT
 2. A -INPUT
 3. A +INPUT
 4. V⁻
 5. B +INPUT
 6. B -INPUT
 7. B OUTPUT
 8. V⁺

■ EQUIVALENT CIRCUIT (1/2 Shown)

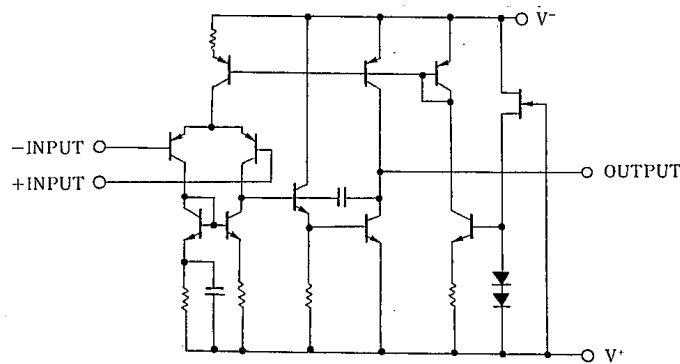

■ ABSOLUTE MAXIMUM RATINGS

(Ta=25°C)

PARAMETER	SYMBOL	RATINGS	UNIT
Supply Voltage	V ⁺ /V ⁻	±7.0	V
Differential Input Voltage	V _{ID}	±14	V
Power Dissipation	P _D	(DIP8) 500	mW
		(DIM8) 300	mW
		(SIP8) 800	mW
		(SSOP8) 250	mW
Operating Temperature Range	T _{opr}	-40~+85	°C
Storage Temperature Range	T _{stg}	-40~+125	°C

■ ELECTRICAL CHARACTERISTICS

(V⁺/V⁻=±2.5V, Ta=25°C)

PARAMETER	SYMBOL	TEST CONDITION	MIN.	TYP.	MAX.	UNIT
Input Offset Voltage	V _{IO}	R _S ≤ 10kΩ	—	1	6	mV
Input Bias Current	I _B		—	100	300	nA
Large Signal Voltage Gain	A _V	R _L ≥ 10kΩ	60	80	—	dB
Maximum Output Voltage Swing	V _{OM}	R _L ≥ 2.5kΩ	±2	±2.2	—	V
Input Common Mode Voltage Range	V _{ICM}		±1.5	—	—	V
Common Mode Rejection Ratio	CMR		60	74	—	dB
Supply Voltage Rejection Ratio	SVR		60	80	—	dB
Operating Current	I _{CC}	V _{IN} =0, R _L =∞	—	3.5	5	mA
Slew Rate	SR	A _U =1, V _{IN} =±1V	—	4	—	V/μs
Gain Bandwidth product	GB	f=10kHz	—	12	—	MHz

(note 1) Applied circuit voltage gain is desired to be operated within the range of 3 dB to 30 dB.

(note 2) Special care being required for input common mode voltage range and the oscillation due to the capacitive load when operating follower.

4

■ TYPICAL CHARACTERISTICS

Operating Current vs. Temperature

($V^+/V^- = \pm 2.5V$, $T_a = 25^\circ C$)

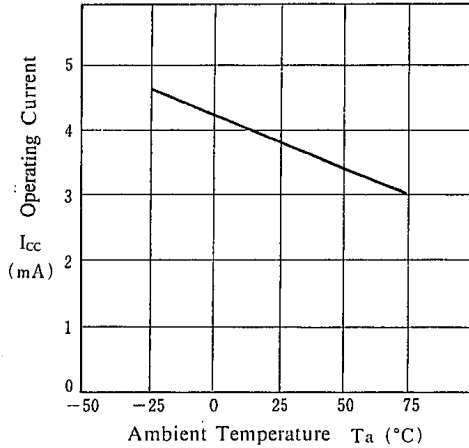

Input Offset Voltage vs. Temperature

($V^+/V^- = \pm 2.5V$, $R_L = 10k\Omega$)

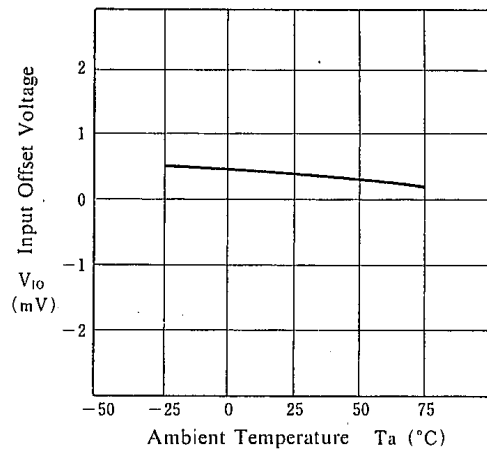

Input Bias Current vs. Temperature

($V^+/V^- = \pm 2.5V$)

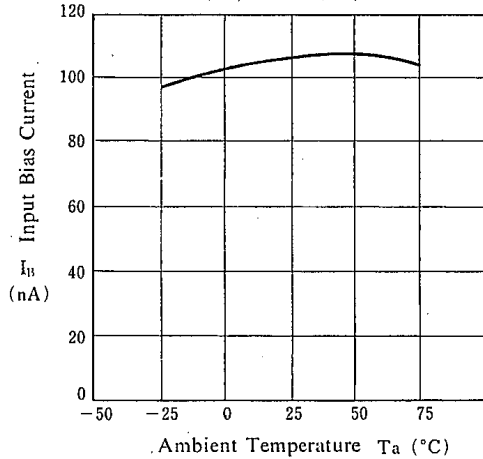

Maximum Output Voltage Swing vs. Temperature

($V^+/V^- = \pm 2.5V$, $R_L = 2.5k\Omega$)

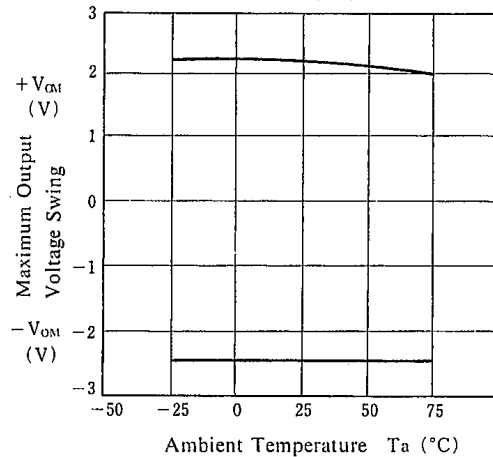

4

TYPICAL CHARACTERISTICS

Voltage Gain vs. Frequency

($V^+/V^- = \pm 12.5V$, $T_a = 25^\circ C$)

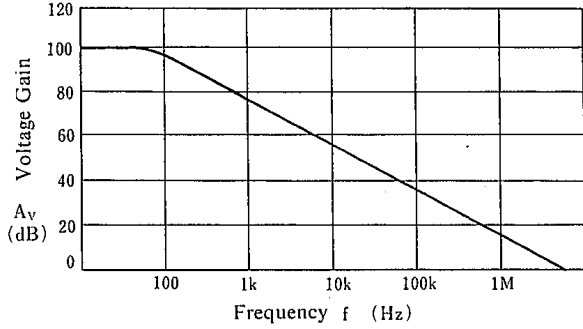

Voltage Gain, Phase vs. Frequency

($T_a = 25^\circ C$, $V^+/V^- = \pm 2.5V$)

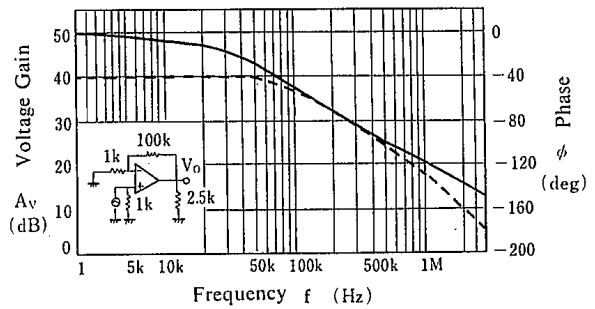

Total Harmonic Distortion vs. Output Voltage

($V^+/V^- = \pm 3V$, $R_L = 2.4k\Omega$, Gain = 10dB, $T_a = 25^\circ C$)

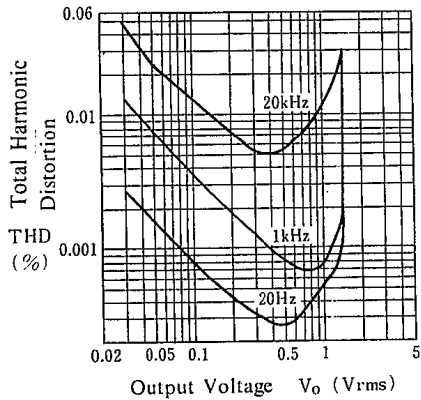

Equivalent Input Noise Voltage vs. Source Resistance

($V^+/V^- = \pm 3V$, $T_a = 25^\circ C$)

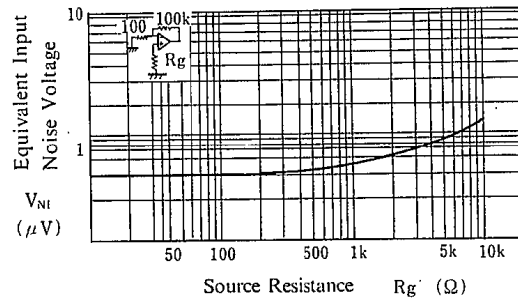

Maximum Output Voltage Swing vs. Load Resistance

($V^+/V^- = \pm 2.5V$, $T_a = 25^\circ C$)

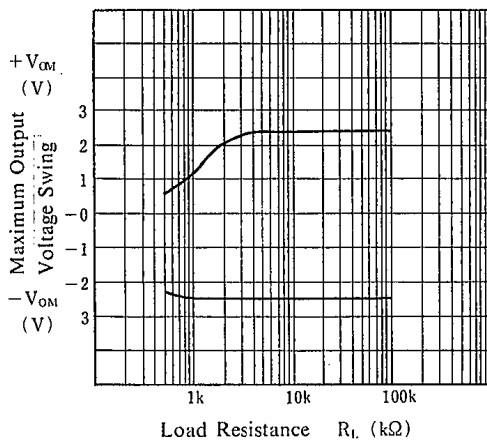

Maximum Output Voltage Swing vs. Frequency

($V^+/V^- = \pm 2.5V$, $R_L = 2.5k\Omega$, $T_a = 25^\circ C$)

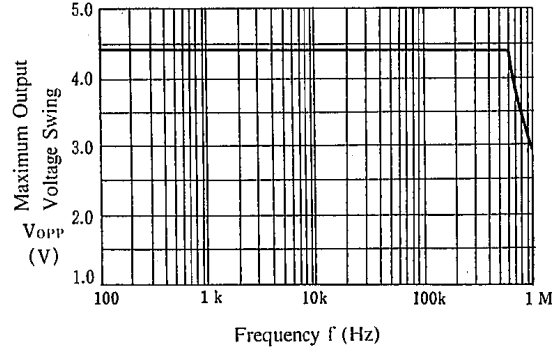

4

■ TYPICAL CHARACTERISTICS

Operating Current vs. Operating Voltage

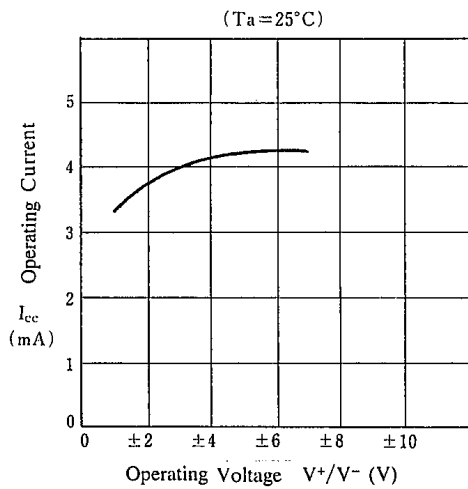

Input Offset Voltage vs. Operating Voltage

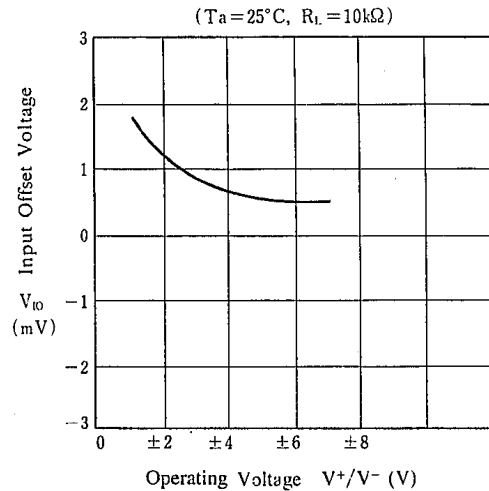

Maximum Output Voltage Swing vs. Operating Voltage

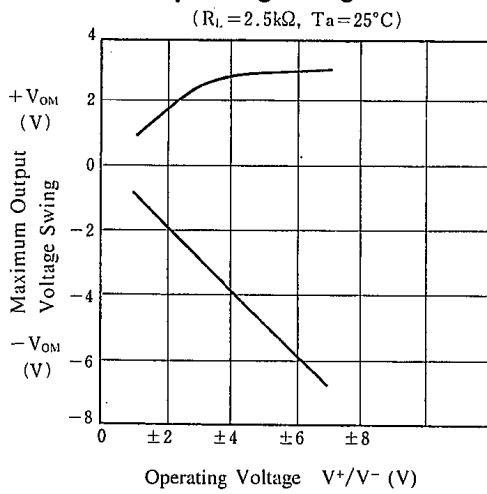

Input Bias Current vs. Operating Voltage

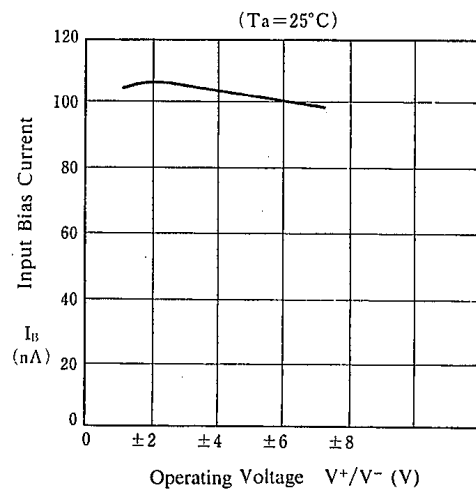

NJM2115

MEMO

[CAUTION]

The specifications on this databook are only given for information, without any guarantee as regards either mistakes or omissions. The application circuits in this databook are described only to show representative usages of the product and not intended for the guarantee or permission of any right including the industrial rights.

New Japan Radio Co., Ltd.