

VOLTAGE AND CURRENT CONTROL IC

■ GENERAL DESCRIPTION

The NJM2146B is a voltage and current control IC which contains single-supply low offset voltage OP-AMP(2mV max.), low operating OP-AMP, and precision voltage reference. It is suitable for battery charger, second controller of switching regulator systems, and other battery systems.

■ PACKAGE OUTLINE

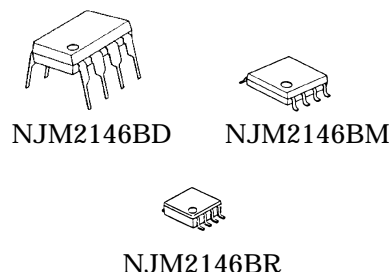

■ FEATURES

- Operating Voltage (2.5V ~ 18V)
- Internal Precision Voltage Reference (1.5V±1%)
- PC Terminal Current (60mA max.)
- Operating Current (3mA max.)
- Bipolar Technology
- Package Outline DIP8, DMP8, VSP8

■ PIN CONFIGURATION

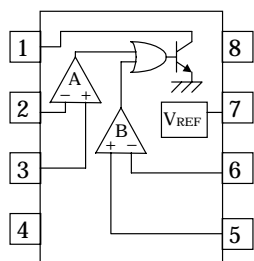

PIN FUNCTION

1. PC
2. A -INPUT
3. A +INPUT
4. GND
5. B +INPUT
6. B -INPUT
7. V_{REF}
8. V⁺

■ ABSOLUTE MAXIMUM RATINGS

(Ta=25°C)

PARAMETER	SYMBOL	RATINGS	UNIT
Supply Voltage	V ⁺	20	V
Differential Input Voltage	V _{ID}	(A _{ch}) 20 (B _{ch}) ±4	V
Power Dissipation	P _D	(DIP8) 500 (DMP8) 300 (VSP8) 320	mW
PC Terminal Current	I _{pc}	60	mA
Operating Temperature Range	T _{opr}	-40 ~ 85	°C
Storage Temperature Range	T _{stg}	-50 ~ 150	°C

(note) When the supply voltage is less than 20V, the absolute maximum input voltage is equal to the supply voltage

■ RECOMMENDED OPERATING CONDITIONS

(Ta=25°C)

PARAMETER	SYMBOL	RATINGS	UNIT
Operating Voltage	V _{opr}	2.5 ~ 18	V

■ ELECTRICAL CHARACTERISTICS

($V^+=5V$, $T_a=25^\circ C$)

PARAMETER	SYMBOL	CONDITIONS	MIN.	TYP.	MAX.	UNIT
Operating Current	I_{CC}	$I_{PC}=\text{off}$	–	1	3	mA
Leakage Current	I_{PCLEAK}	$V^+=V_{PC}=20V$	–	–	100	μA
Saturation Voltage	$V_{PC(SAT)}$	$I_{PC}=50mA$	–	0.5	0.7	V
Reference Voltage	V_{REF}	$I_{REF}=0mA$	1485	1500	1515	mV
Reference Voltage Load Regulation	$\Delta V_{REF}/\Delta I_{REF}$	$I_{REF}=0 \sim 5mA$	–	–	30	mV

[Ach]

PARAMETER	SYMBOL	CONDITIONS	MIN.	TYP.	MAX.	UNIT
Input Offset Voltage	V_{IO}		–	0.5	2	mV
Input Offset Current	I_{IO}		–	5	50	nA
Input Bias Current	I_B		–	80	250	nA
Large Signal Voltage Gain	A_V		–	80	–	dB
Input Common Mode Voltage Range	V_{ICM}		0 to 3	–	–	V
Common Mode Rejection Ratio	CMR		–	90	–	dB
Supply Voltage Rejection Ratio	SVR		–	80	–	dB
Slew Rate	SR		–	0.8	–	V/ μs
Gain Bandwidth Product	GB	$f=10kHz$	–	2	–	MHz

[Bch]

PARAMETER	SYMBOL	CONDITIONS	MIN.	TYP.	MAX.	UNIT
Input Offset Voltage	V_{IO}		–	1	6	mV
Input Offset Current	I_{IO}		–	10	50	nA
Input Bias Current	I_B		–	100	300	nA
Large Signal Voltage Gain	A_V		–	80	–	dB
Input Common Mode Voltage Range	V_{ICM}		1.0 to 4.4	–	–	V
Common Mode Rejection Ratio	CMR		–	90	–	dB
Supply Voltage Rejection Ratio	SVR		–	80	–	dB
Slew Rate	SR	$A_V=1$, $V_{IN}=2.5V \pm 1V$	–	0.5	–	V/ μs
Gain Bandwidth Product	GB	$f=10kHz$	–	1	–	MHz

■ TYPICAL APPLICATION

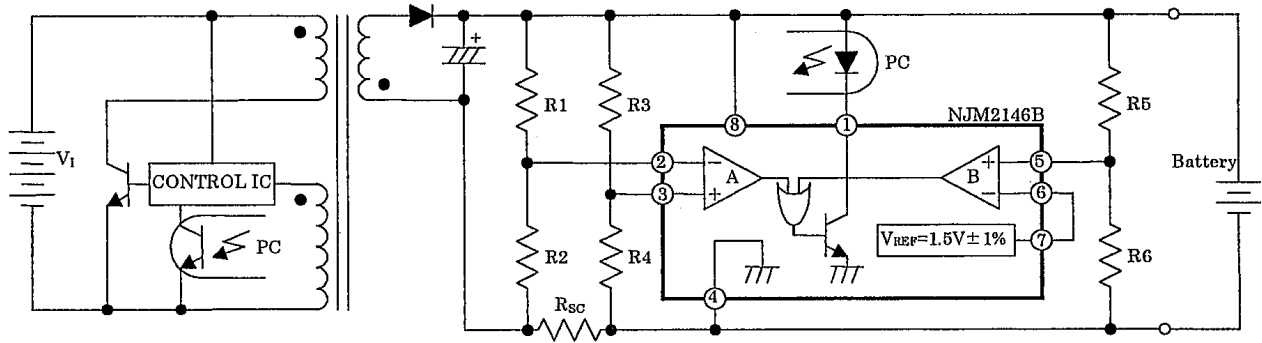

TYPICAL CHARACTERISTICS

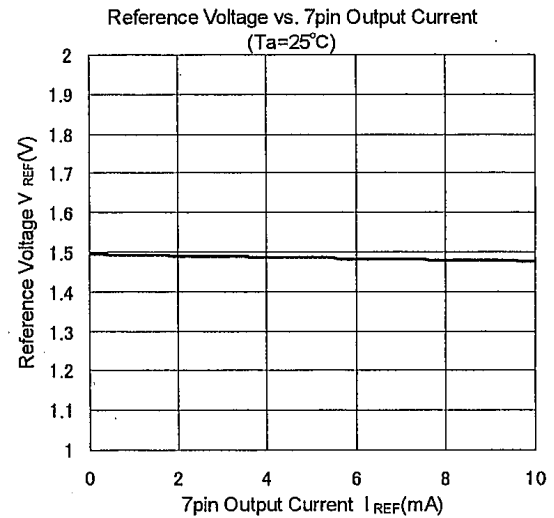
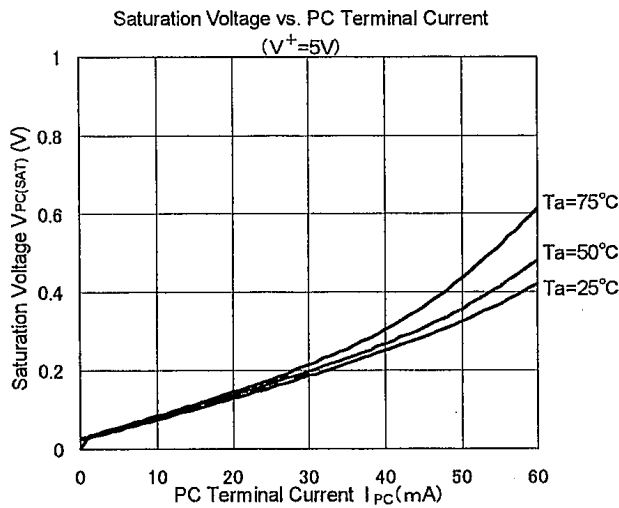
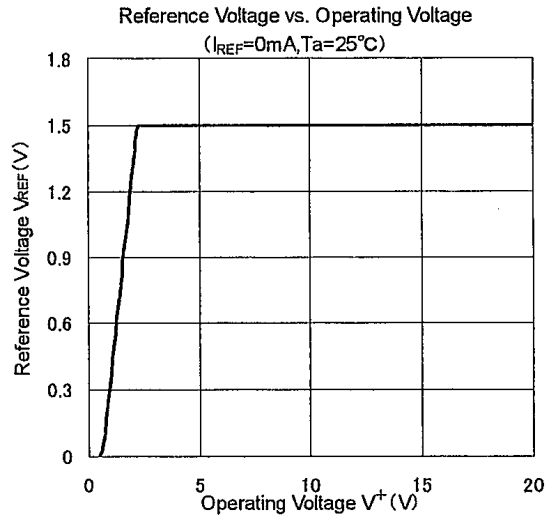
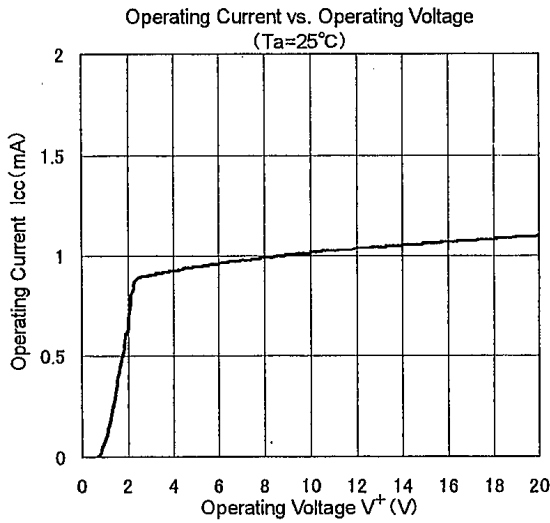
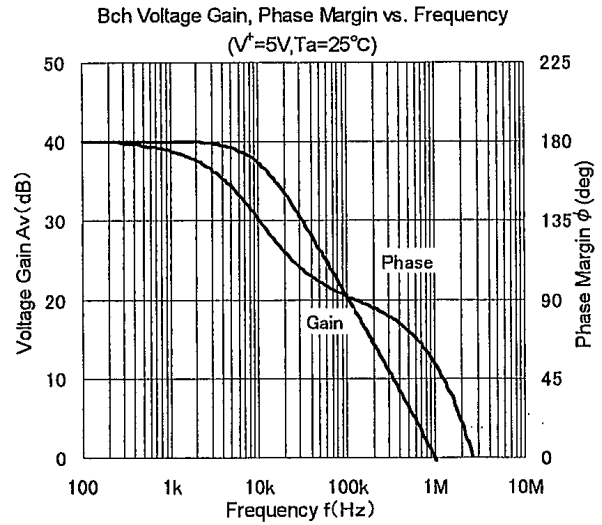
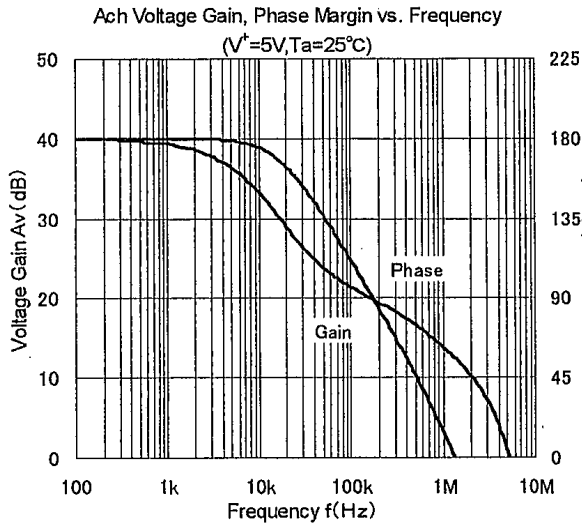

■ TYPICAL CHARACTERISTICS

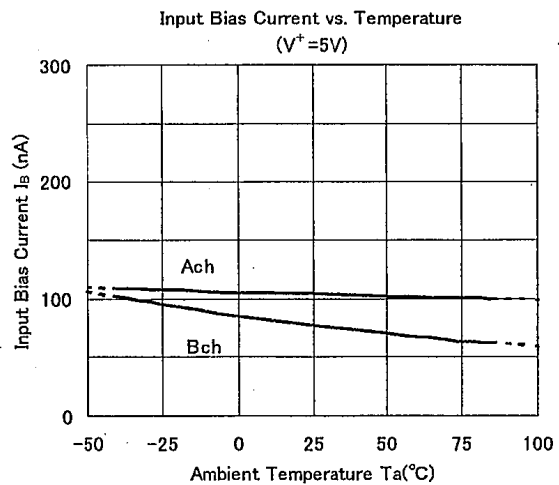
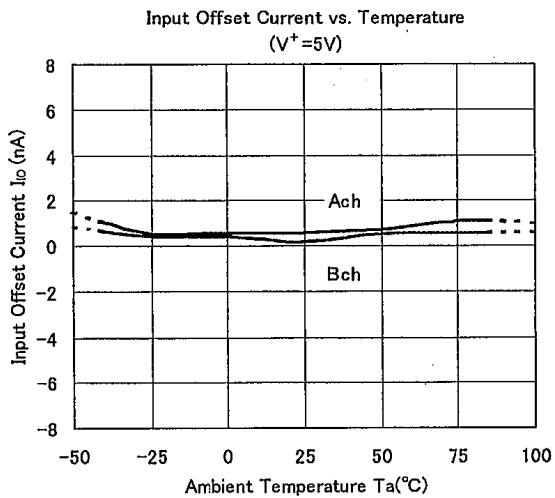
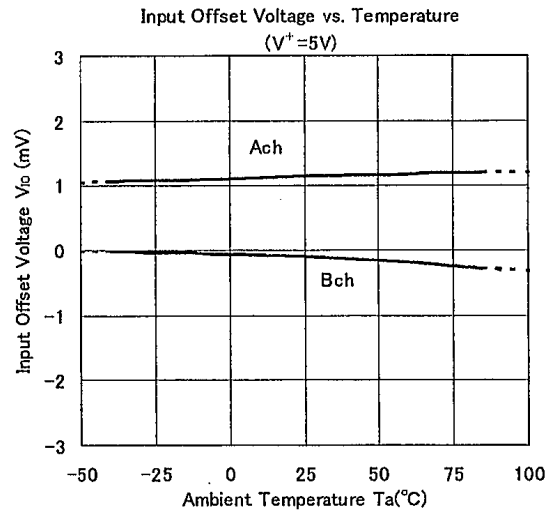
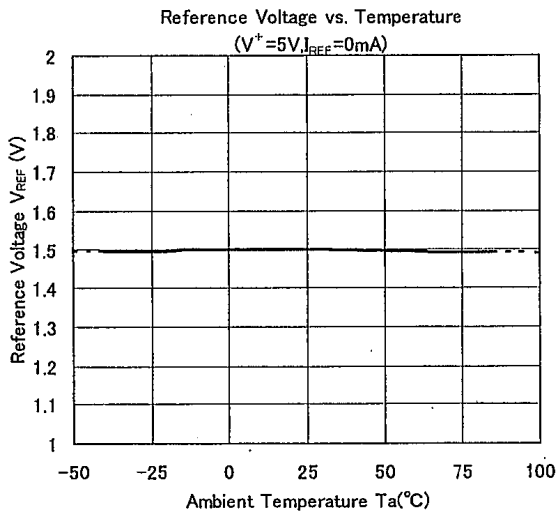
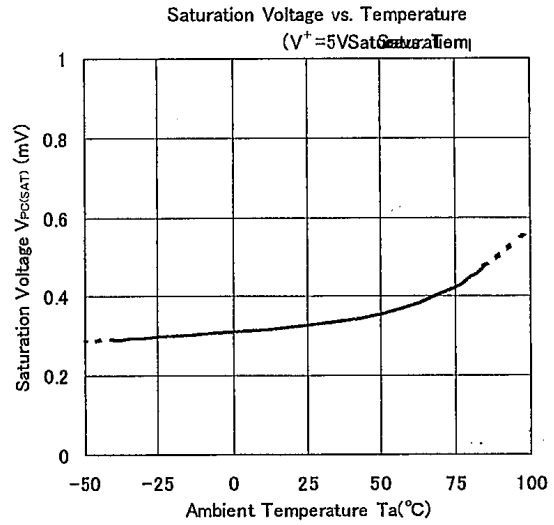
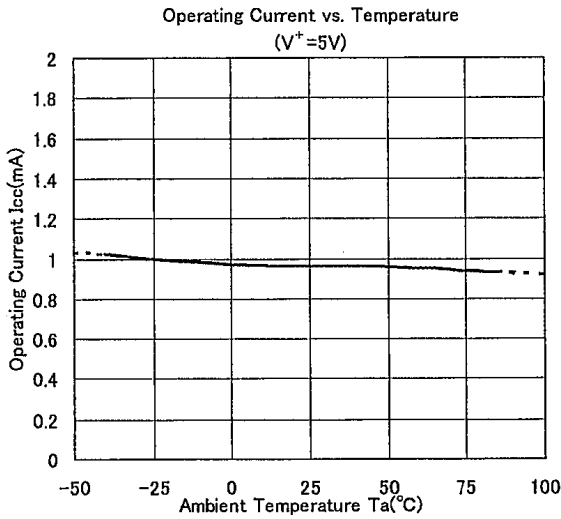

6

MEMO

[CAUTION]
The specifications on this databook are only given for information, without any guarantee as regards either mistakes or omissions. The application circuits in this databook are described only to show representative usages of the product and not intended for the guarantee or permission of any right including the industrial rights.