

MSM56V16160F

2-Bank × 524,288 Word × 16 Bit SYNCHRONOUS DYNAMIC RAM

DESCRIPTION

The MSM56V16160F is a 2-Bank × 524,288-word × 16 bit Synchronous dynamic RAM, fabricated in OKI's CMOS silicon-gate process technology. The device operates at 3.3V. The inputs and outputs are LVTTTL compatible.

FEATURES

- Silicon gate , quadruple polysilicon CMOS , 1-transistor memory cell
- 2-bank × 524,288-word × 16bit configuration
- 3.3V power supply ± 0.3V tolerance
- Input : LVTTTL compatible
- Output : LVTTTL compatible
- Refresh : 4096 cycles/64 ms
- Programmable data transfer mode
 - $\overline{\text{CAS}}$ Latency (1,2,3)
 - Burst Length (1,2,4,8,Full page)
 - Data scramble (sequential , interleave)
- CBR auto-refresh, Self-refresh capability
- Package:
50-pin 400mil plastic TSOP (Type II) (TSOPII50-P-400-0.80-K) (Product : MSM56V16160F-xxTS-K)
xx : indicates speed rank.

PRODUCT FAMILY

Family	Max. Frequency	Access Time (Max.)	
		t _{AC2}	t _{AC3}
MSM56V16160F-8	125MHz	9ns	6ns
MSM56V16160F-10	100MHz	9ns	9ns

PIN CONFIGURATION (TOP VIEW)

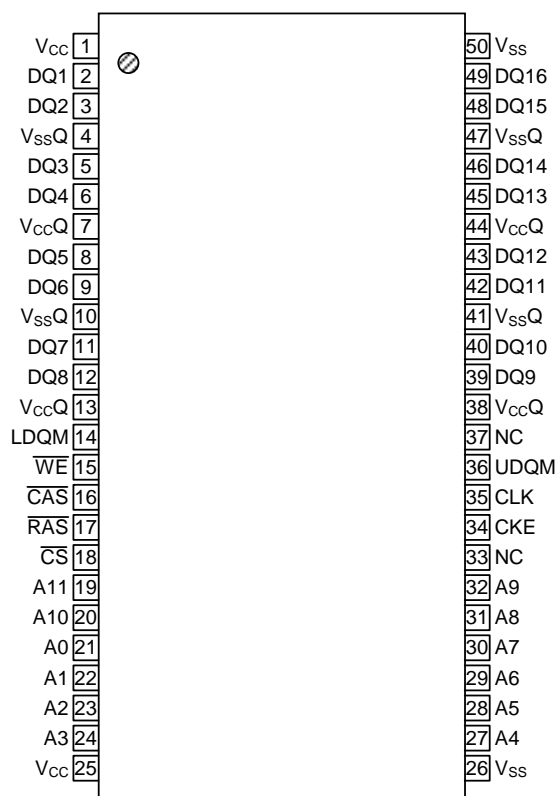

50-Pin Plastic TSOP (II)
(K Type)

Pin Name	Function	Pin Name	Function
CLK	System Clock	UDQM, LDQM	Data Input/Output Mask
$\overline{\text{CS}}$	Chip Select	DQi	Data Input/Output
CKE	Clock Enable	V _{CC}	Power Supply (3.3V)
A0–A10	Address	V _{SS}	Ground (0V)
A11	Bank Select Address	V _{CCQ}	Data Output Power Supply (3.3V)
$\overline{\text{RAS}}$	Row Address Strobe	V _{SSQ}	Data Output Ground (0V)
$\overline{\text{CAS}}$	Column Address Strobe	NC	No Connection
$\overline{\text{WE}}$	Write Enable		

Note: The same power supply voltage must be provided to every V_{CC} pin and V_{CCQ} pin.
The same GND voltage level must be provided to every V_{SS} pin and V_{SSQ} pin.

PIN DESCRIPTION

CLK	Fetches all inputs at the "H" edge.
$\overline{\text{CS}}$	Disables or enables device operation by asserting or deactivating all inputs except CLK, CKE, UDQM and LDQM.
CKE	Masks system clock to deactivate the subsequent CLK operation. If CKE is deactivated, system clock will be masked so that the subsequent CLK operation is deactivated. CKE should be asserted at least one cycle prior to a new command.
Address	Row & column multiplexed. Row address : RA0 – RA10 Column Address : CA0 – CA7
A11	Selects bank to be activated during row address latch time and selects bank for precharge and read/write during column address latch time. A11="L" : Bank A, A11="H" : Bank B
$\overline{\text{RAS}}$ $\overline{\text{CAS}}$ $\overline{\text{WE}}$	Functionality depends on the combination. For details, see the function truth table.
UDQM, LDQM	Masks the read data of two clocks later when UDQM and LDQM are set "H" at the "H" edge of the clock signal. Masks the write data of the same clock when UDQM and LDQM are set "H" at the "H" edge of the clock signal. UDQM controls upper byte and LDQM controls lower byte.
DQi	Data inputs/outputs are multiplexed on the same pin.

BLOCK DIAGRAM

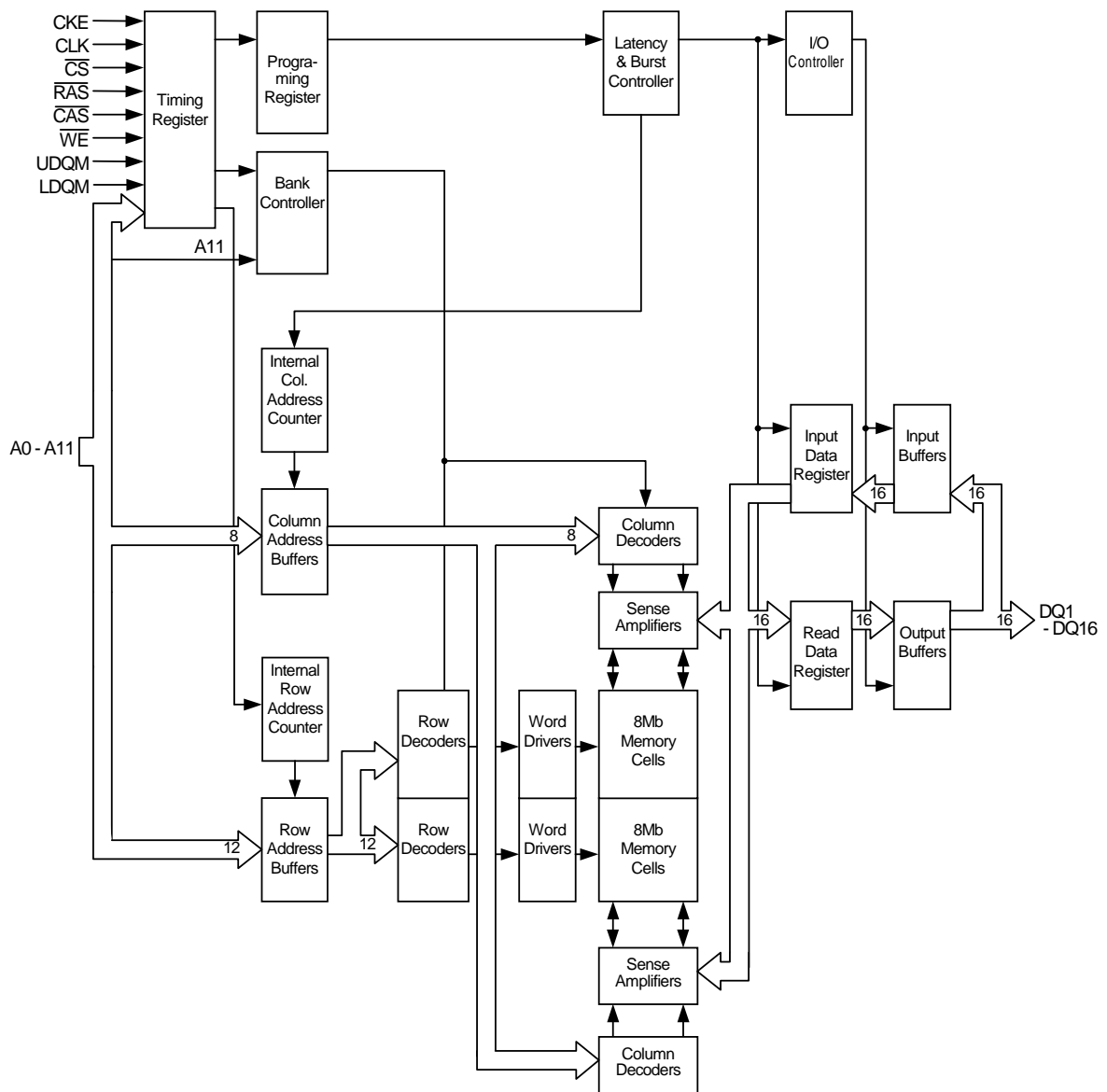

ELECTRICAL CHARACTERISTICS

Absolute Maximum Ratings

(Voltages referenced to V_{SS})

Parameter	Symbol	Rating	Unit
Voltage on Any Pin Relative to V_{SS}	V_{IN}, V_{OUT}	-0.5 to $V_{CC} + 0.5$	V
V_{CC} Supply Voltage	V_{CC}, V_{CCQ}	-0.5 to 4.6	V
Storage Temperature	T_{stg}	-55 to 150	°C
Power Dissipation	P_D^*	600	mW
Short Circuit Current	I_{OS}	50	mA
Operating Temperature	T_{opr}	0 to 70	°C

*: $T_a = 25^\circ\text{C}$

Recommended Operating Conditions

(Voltages referenced to $V_{SS} = 0V$)

Parameter	Symbol	Min.	Typ.	Max.	Unit
Power Supply Voltage	V_{CC}, V_{CCQ}	3.0	3.3	3.6	V
Input High Voltage	V_{IH}	2.0	—	$V_{CC} + 0.2$	V
Input Low Voltage	V_{IL}	-0.3	—	0.8	V

Capacitance

 $(V_{BIAS} = 1.4V, T_a = 25^\circ\text{C}, f = 1\text{MHz})$

Parameter	Symbol	Min.	Max.	Unit
Input Capacitance (CLK)	C_{CLK}	2.5	4	pF
Input Capacitance (\overline{RAS} , \overline{CAS} , \overline{WE} , \overline{CS} , \overline{CKE} , \overline{UDQM} , \overline{LDQM} , A0-A11)	C_{IN}	2.5	5	pF
Input/Output Capacitance (DQ1-DQ16)	C_{OUT}	4	6.5	pF

DC Characteristics

Parameter	Symbol	Condition			MSM56V16160				Unit	Note
					F-8		F-10			
		Bank	CKE	Others	Min	Max	Min	Max		
Output High Voltage	V_{OH}	—	—	$I_{OH} = -2.0mA$	2.4	—	2.4	—	V	
Output Low Voltage	V_{OL}	—	—	$I_{OL} = 2.0mA$	—	0.4	—	0.4	V	
Input Leakage Current	I_{LI}	—	—	—	-10	10	-10	10	μA	
Input Leakage Current	I_{LO}	—	—	—	-10	10	-10	10	μA	
Average power supply current (Operating)	I_{CC1}	One Bank Active	$CKE \geq V_{IH}$	$t_{CC} = \text{min.}$ $t_{RC} = \text{min.}$ No Burst	—	80	—	70	mA	1,2
	I_{CC1D}	Both Banks Active	$CKE \geq V_{IH}$	$t_{CC} = \text{min.}$ $t_{RC} = \text{min.}$ $t_{RRD} = \text{min.}$ No Burst	—	115	—	95	mA	1,2
Power supply current (Standby)	I_{CC2}	Both Banks Precharge	$CKE \geq V_{IH}$	$t_{CC} = \text{min.}$	—	35	—	30	mA	3
Average power supply current (Clock Suspension)	I_{CC3S}	Both Banks Active	$CKE \leq V_{IL}$	$t_{CC} = \text{min.}$	—	3	—	3	mA	2
Average power supply current (Active Standby)	I_{CC3}	One Bank Active	$CKE \geq V_{IH}$	$t_{CC} = \text{min.}$	—	40	—	35	mA	3
Power supply current (Burst)	I_{CC4}	Both Banks Active	$CKE \geq V_{IH}$	$t_{CC} = \text{min.}$	—	125	—	100	mA	1,2
Power supply current (Auto-Refresh)	I_{CC5}	One Bank Active	$CKE \geq V_{IH}$	$t_{CC} = \text{min.}$ $t_{RC} = \text{min.}$	—	80	—	70	mA	2
Average power supply current (Self-Refresh)	I_{CC6}	Both Banks Precharge	$CKE \leq V_{IL}$	$t_{CC} = \text{min.}$	—	2	—	2	mA	
Average power supply current (Power Down)	I_{CC7}	Both Banks Precharge	$CKE \leq V_{IL}$	$t_{CC} = \text{min.}$	—	2	—	2	mA	

- Notes: 1. Measured with outputs open.
2. The address and data can be changed once or left unchanged during one cycle.
3. The address and data can be changed once or left unchanged during two cycles.

Mode Set Address Keys

CAS Latency				Burst Type		Burst Length				
A6	A5	A4	CL	A3	BT	A2	A1	A0	BT = 0	BT = 1
0	0	0	Reserved	0	Sequential	0	0	0	1	1
0	0	1	1	1	Interleave	0	0	1	2	2
0	1	0	2			0	1	0	4	4
0	1	1	3			0	1	1	8	8
1	0	0	Reserved			1	0	0	Reserved	Reserved
1	0	1	Reserved			1	0	1	Reserved	Reserved
1	1	0	Reserved			1	1	0	Reserved	Reserved
1	1	1	Reserved			1	1	1	Full Page	Reserved

Notes: A7, A8, A9, A10 and A11 should stay “L” during mode set cycle.

POWER ON SEQUENCE

1. With inputs in NOP state, turn on the power supply and start the system clock.
2. After the V_{CC} voltage has reached the specified level, pause for 200 μ s or more with the input kept in NOP state.
3. Issue the precharge all bank command.
4. Apply a CBR auto-refresh eight or more times.
5. Enter the mode register setting command.

AC Characteristic (1/2)

Note 1,2

Parameter		Symbol	MSM56V16160				Unit	Note
			F-8		F-10			
			Min.	Max.	Min.	Max.		
Clock Cycles Time	CL = 3	t_{CC}	8	—	10	—	ns	
	CL = 2		12	—	15	—	ns	
	CL = 1		24	—	30	—	ns	
Access Time from Clock	CL = 3	t_{AC}	—	6	—	9	ns	3,4
	CL = 2		—	9	—	9	ns	3,4
	CL = 1		—	22	—	27	ns	3,4
Clock High Pulse Time		t_{CH}	3	—	3	—	ns	4
Clock Low Pulse Time		t_{CL}	3	—	3	—	ns	4
Input Setup Time		t_{SI}	2	—	3	—	ns	
Input Hold Time		t_{HI}	1	—	1	—	ns	
Output Low Impedance Time from Clock		t_{OLZ}	3	—	3	—	ns	
Output High Impedance Time from Clock		t_{OHZ}	—	8	—	8	ns	
Output Hold from Clock		t_{OH}	3	—	3	—	ns	3
\overline{RAS} Cycle Time		t_{RC}	70	—	90	—	ns	
\overline{RAS} Precharge Time		t_{RP}	20	—	30	—	ns	
\overline{RAS} Active Time		t_{RAS}	48	10^5	60	10^5	ns	
\overline{RAS} to \overline{CAS} Delay Time		t_{RCD}	20	—	30	—	ns	
Write Recovery Time		t_{WR}	8	—	15	—	ns	
\overline{RAS} to \overline{RAS} Bank Active Delay Time		t_{RRD}	20	—	20	—	ns	
Refresh Time		t_{REF}	—	64	—	64	ms	
Power-down Exit setup Time		t_{PDE}	$t_{SI}+1CLK$	—	$t_{SI}+1CLK$	—	ns	
Input Level Transition Time		t_{τ}	—	3	—	3	ns	
\overline{CAS} to \overline{CAS} Delay Time(Min.)		l_{CCD}	1		1		Cycle	
Clock Disable Time from CKE		l_{CKE}	1		1		Cycle	
Data Output High Impedance Time from UDQM, LDQM		l_{DOZ}	2		2		Cycle	
Data Input Mask Time from UDQM, LDQM		l_{DOD}	0		0		Cycle	
Data Input Mask Time from Write Command		l_{DWD}	0		0		Cycle	

AC Characteristic (2/2)

Note 1,2

Parameter	Symbol	MSM56V16160				Unit	Note
		F-8		F-10			
		Min.	Max.	Min.	Max.		
Data Output High Impedance Time from Precharge Command	t_{ROH}	CL		CL		Cycle	
Active Command Input Time from Mode Register Set Command Input (Min.)	t_{MRD}	3		3		Cycle	
Write Command Input Time from Output	t_{OWD}	2		2		Cycle	

Notes:

- 1) AC measurements assume that $t_T = 1\text{ns}$.
- 2) The reference level for timing of input signals is 1.4V.
- 3) Output load.

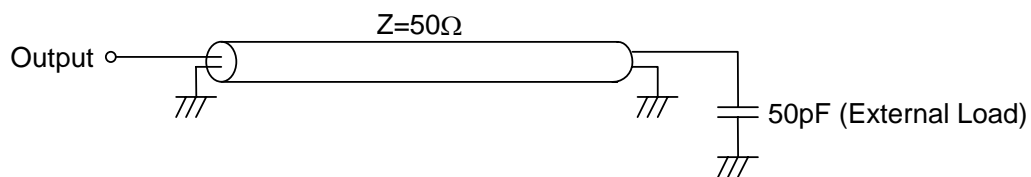

- 4) The access time is defined at 1.5V.
- 5) If t_T is longer than 1ns, then the reference level for timing of input signals is V_{IH} and V_{IL} .

TIMING WAVEFORM

- Read & Write Cycle (Same Bank) @ $\overline{\text{CAS}}$ Latency=2, Burst Length=4

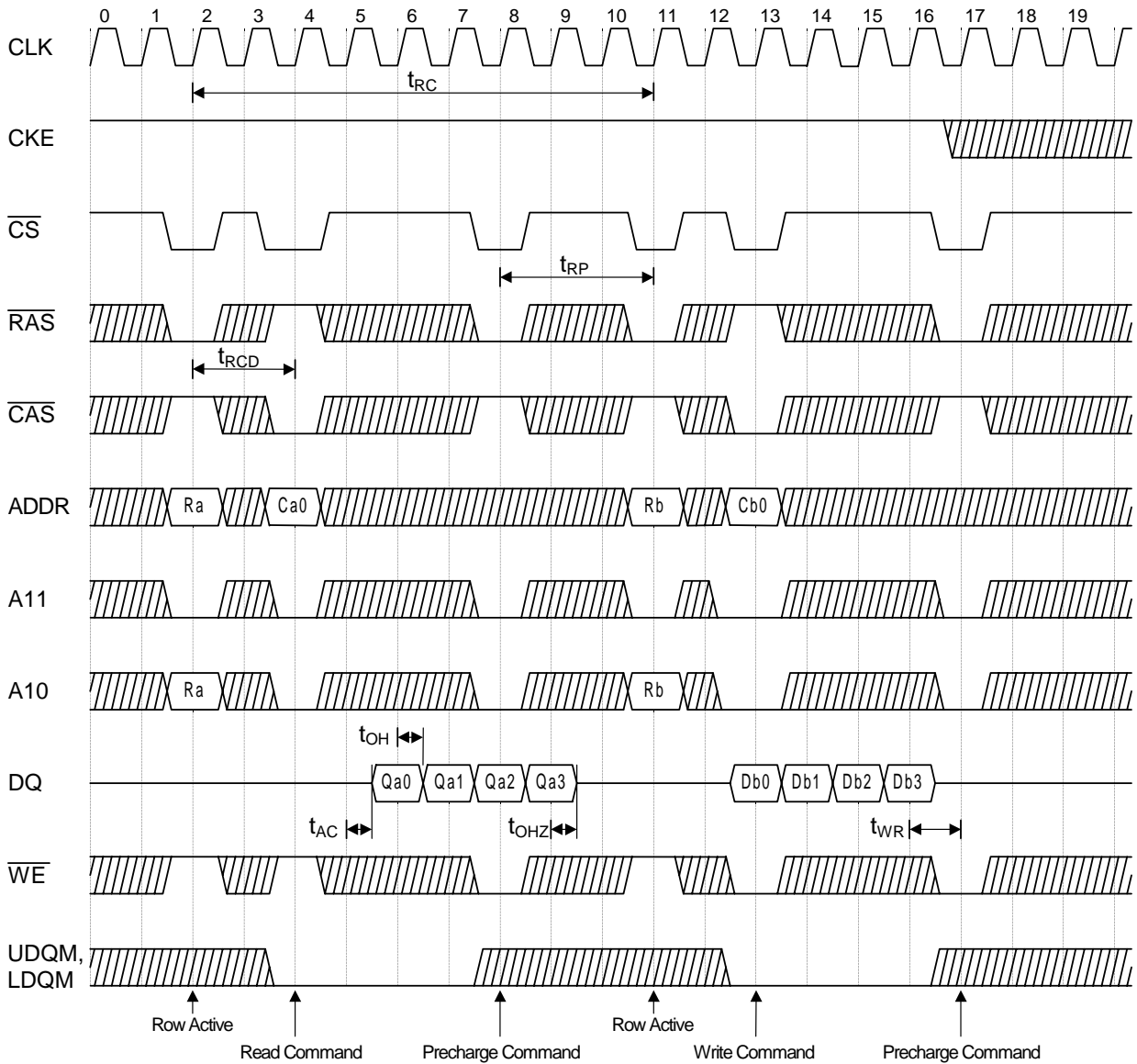

• Single Bit Read-Write-Read Cycle (Same Page) @CAS Latency=2, Burst Length=4

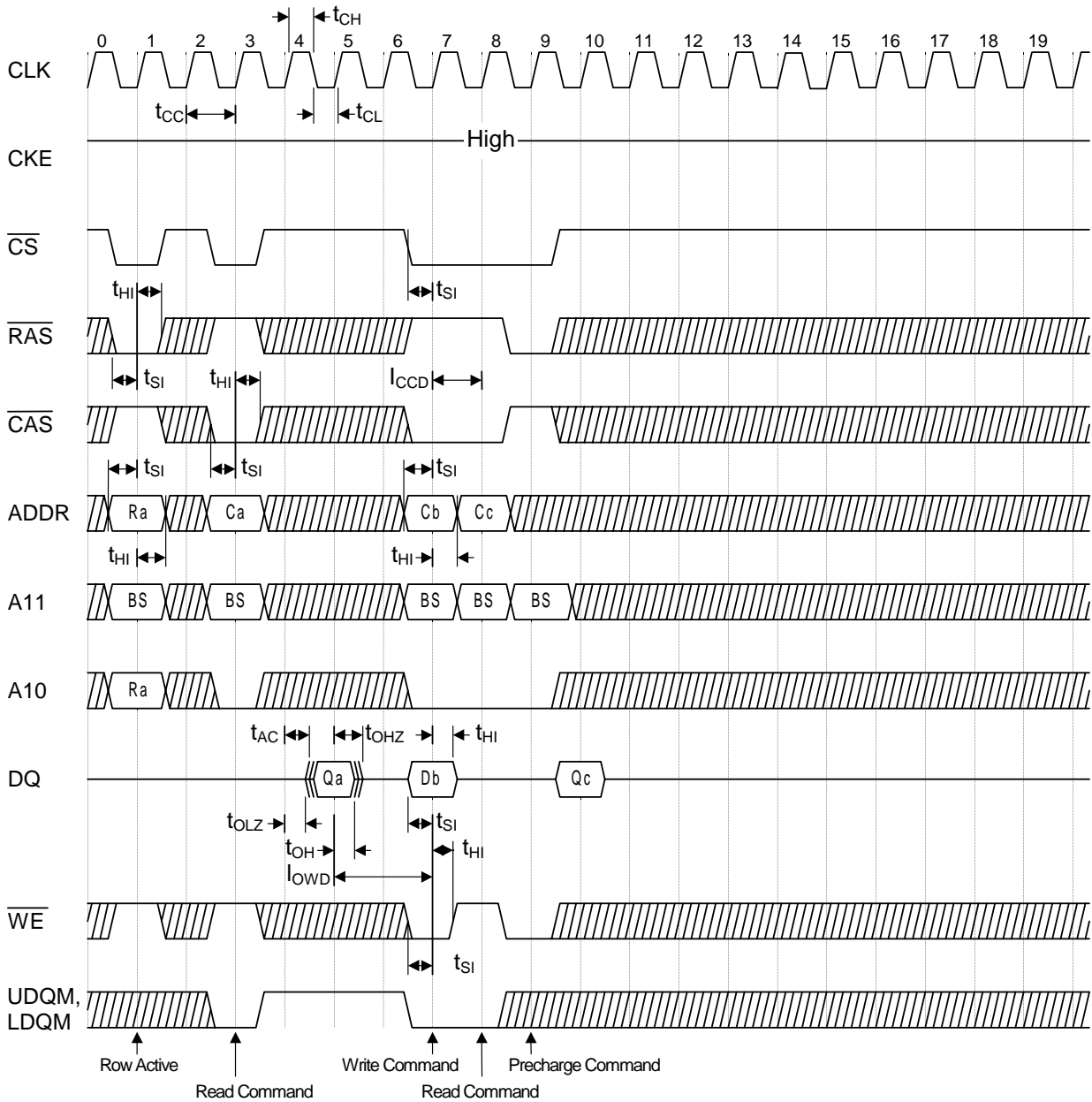

*Notes : 1. When \overline{CS} is set "High" at a clock transition from "Low" to "High", all inputs except CKE, UDQM and LDQM are invalid.

2. When issuing an active, read or write command, the bank is selected by A11.

A11	Active, read or write
0	Bank A
1	Bank B

3. The auto precharge function is enabled or disabled by the A10 input when the read or write command is issued.

A10	A11	Operation
0	0	After the end of burst, bank A holds the idle status.
1	0	After the end of burst, bank A is precharged automatically.
0	1	After the end of burst, bank B holds the idle status.
1	1	After the end of burst, bank B is precharged automatically.

4. When issuing a precharge command, the bank to be precharged is selected by the A10 and A11 inputs.

A10	A11	Operation
0	0	Bank A is precharged.
0	1	Bank B is precharged.
1	X	Both banks A and B are precharged.

5. The input data and the write command are latched by the same clock (Write latency = 0).

6. The output is forced to high impedance by $(1\text{CLK}+t_{\text{OHZ}})$ after UDQM, LDQM entry.

• Page Read & Write Cycle (Same Bank) @CAS Latency=2, Burst Length=4

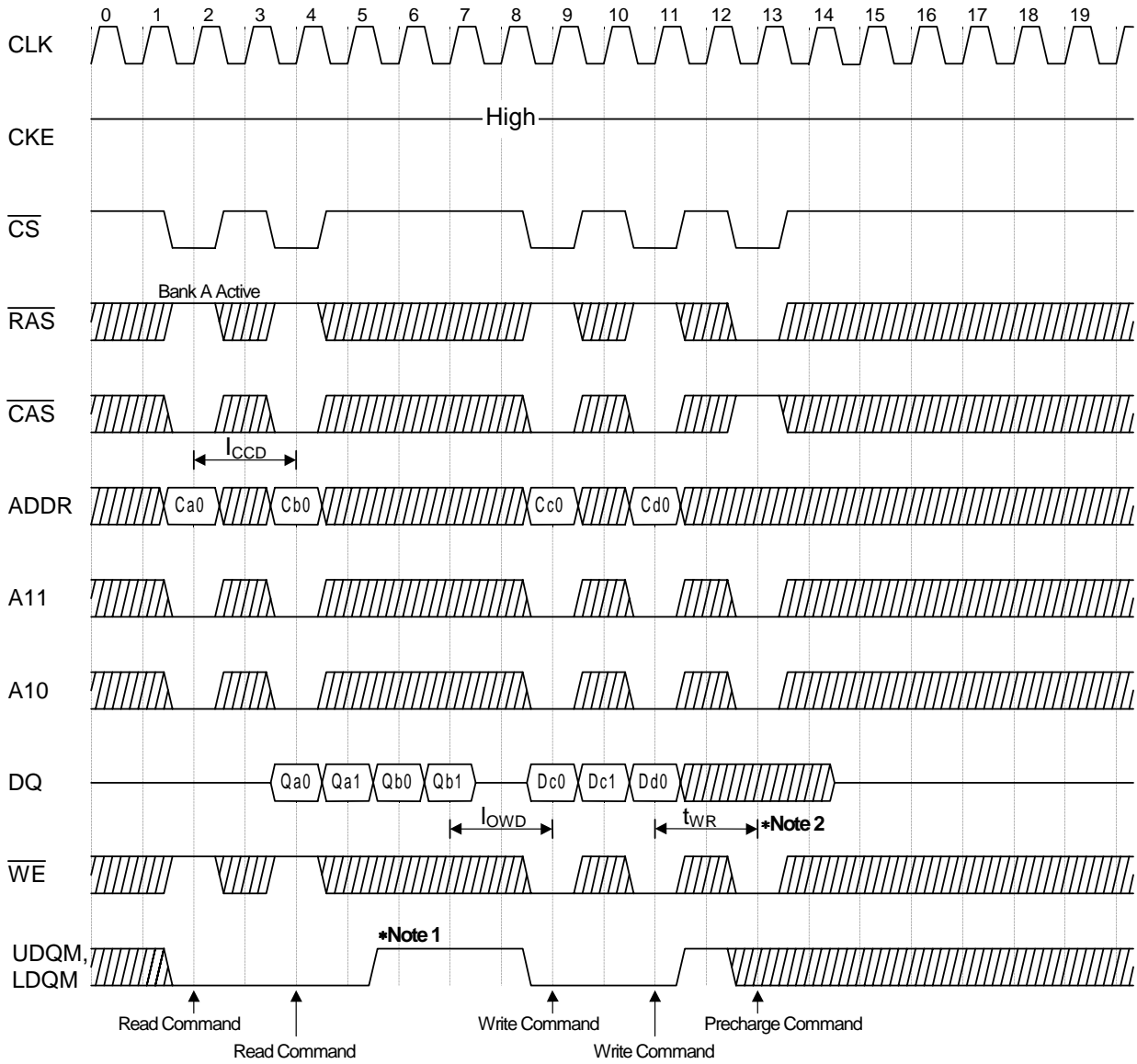

- *Notes:
1. To write data before a burst read ends, UDQM and LDQM should be asserted three cycles prior to the write command to avoid bus contention.
 2. To assert row precharge before a burst write ends, wait t_{WR} after the last write data input. Input data during the precharge input cycle will be masked internally.

• Read & Write Cycle with Auto Precharge @ Burst Length=4

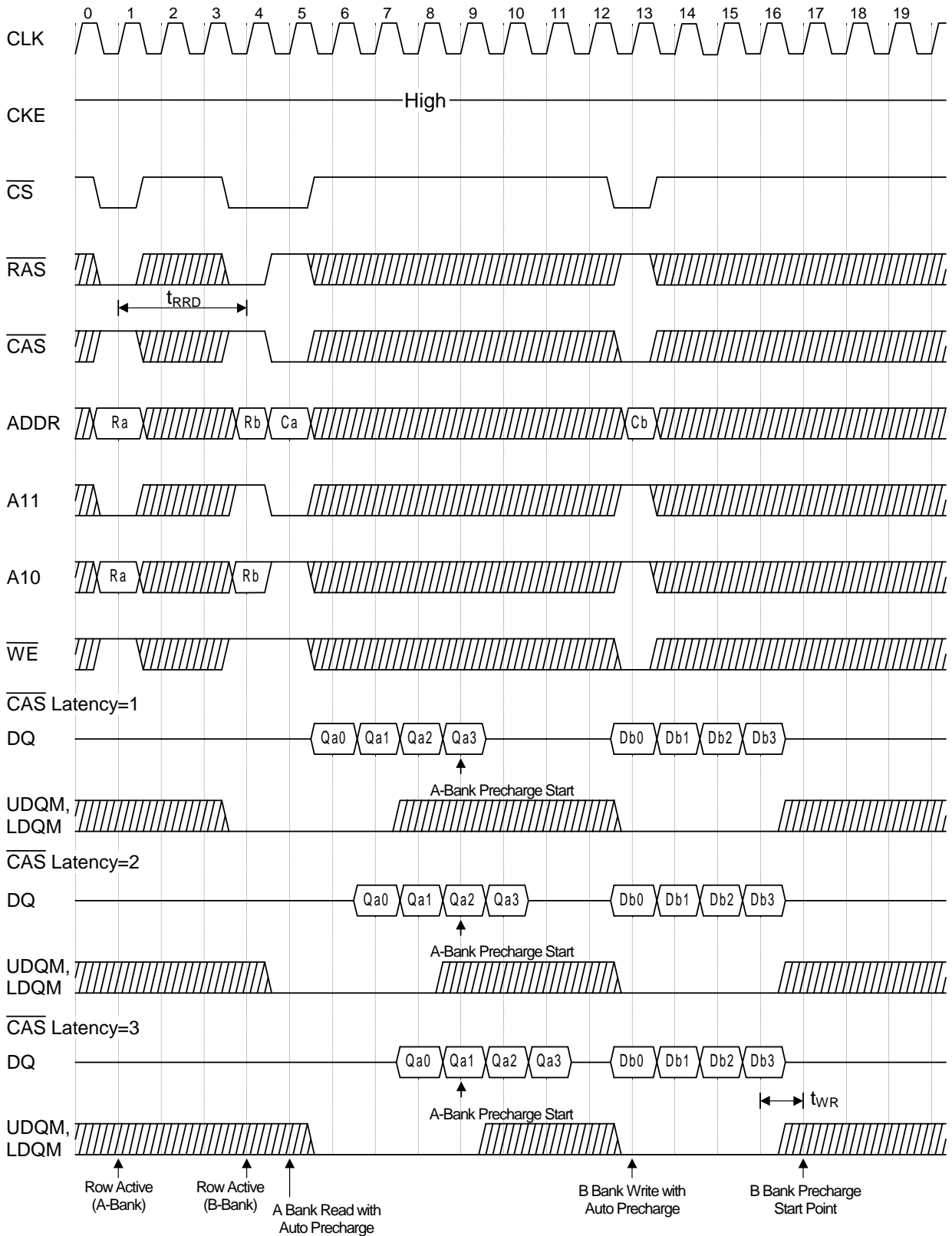

• Bank Interleave Random Row Read Cycle @CAS Latency = 2, Burst Length = 4

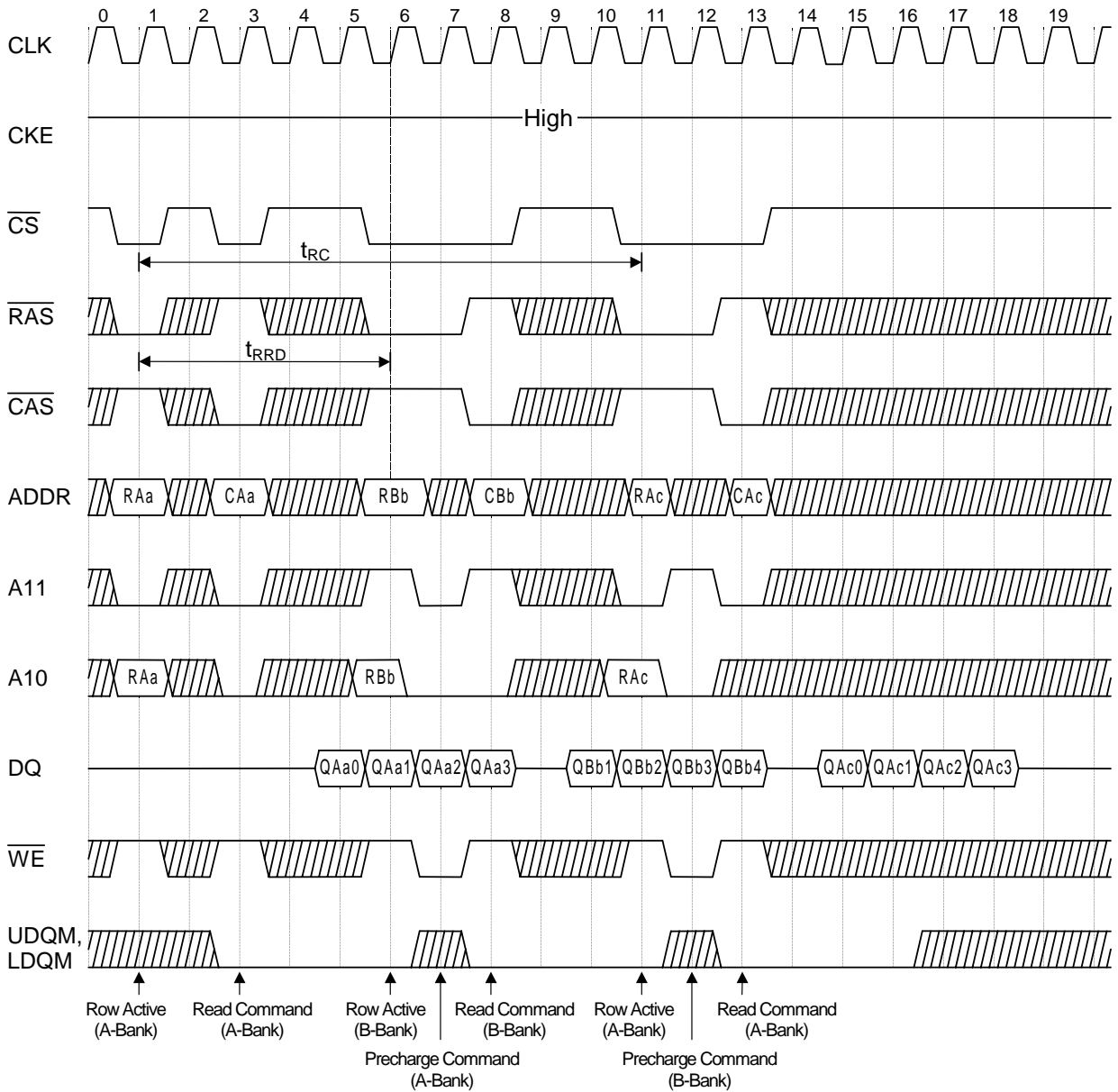

• Bank Interleave Random Row Write Cycle @CAS Latency = 2, Burst Length =4

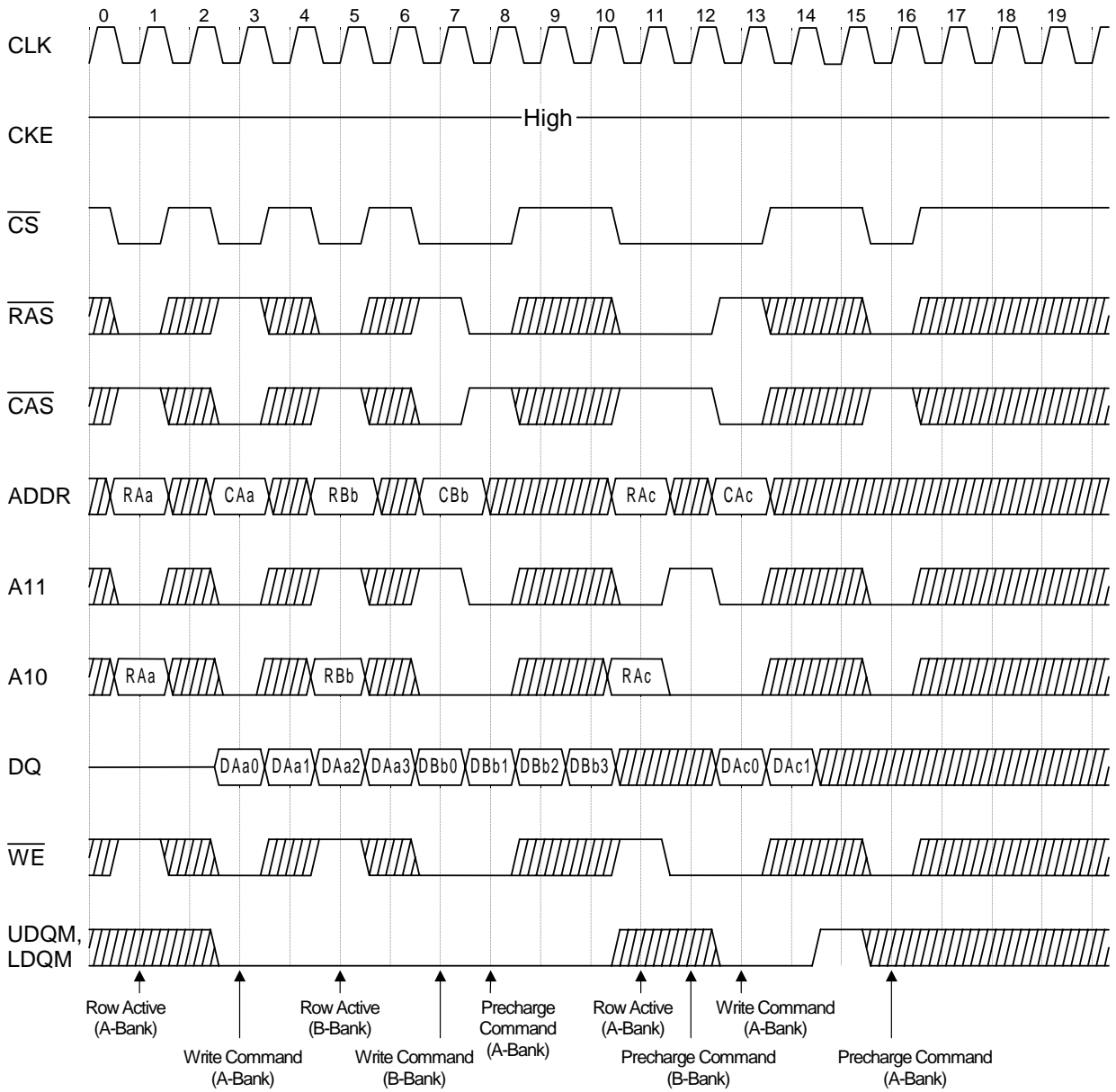

• Bank Interleave Page Read Cycle @ $\overline{\text{CAS}}$ Latency = 2, Burst Length = 4

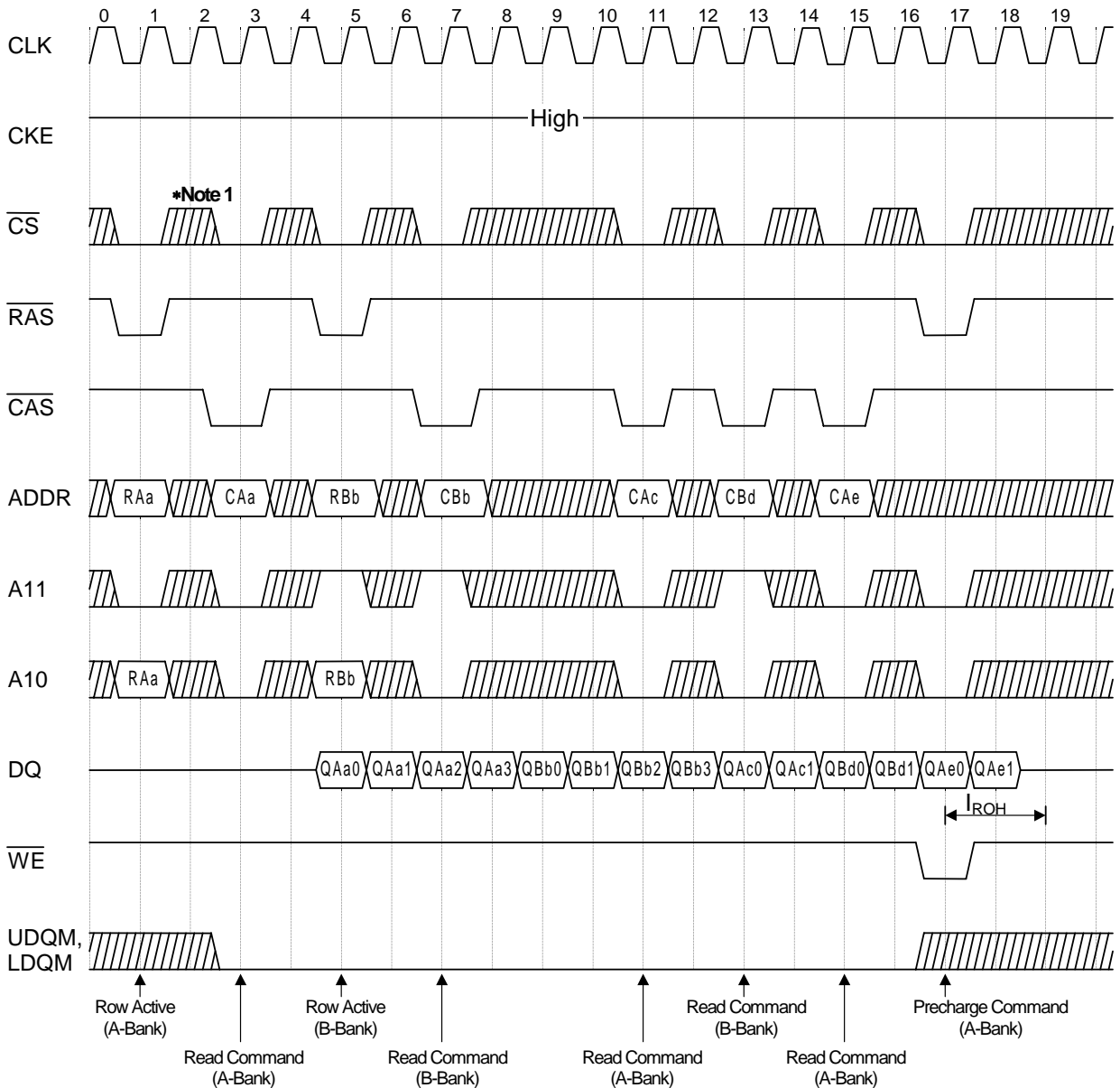

*Note: 1. $\overline{\text{CS}}$ is ignored when $\overline{\text{RAS}}$, $\overline{\text{CAS}}$ and $\overline{\text{WE}}$ are high at the same cycle.

• Bank Interleave Page Write Cycle @CAS Latency = 2, Burst Length=4

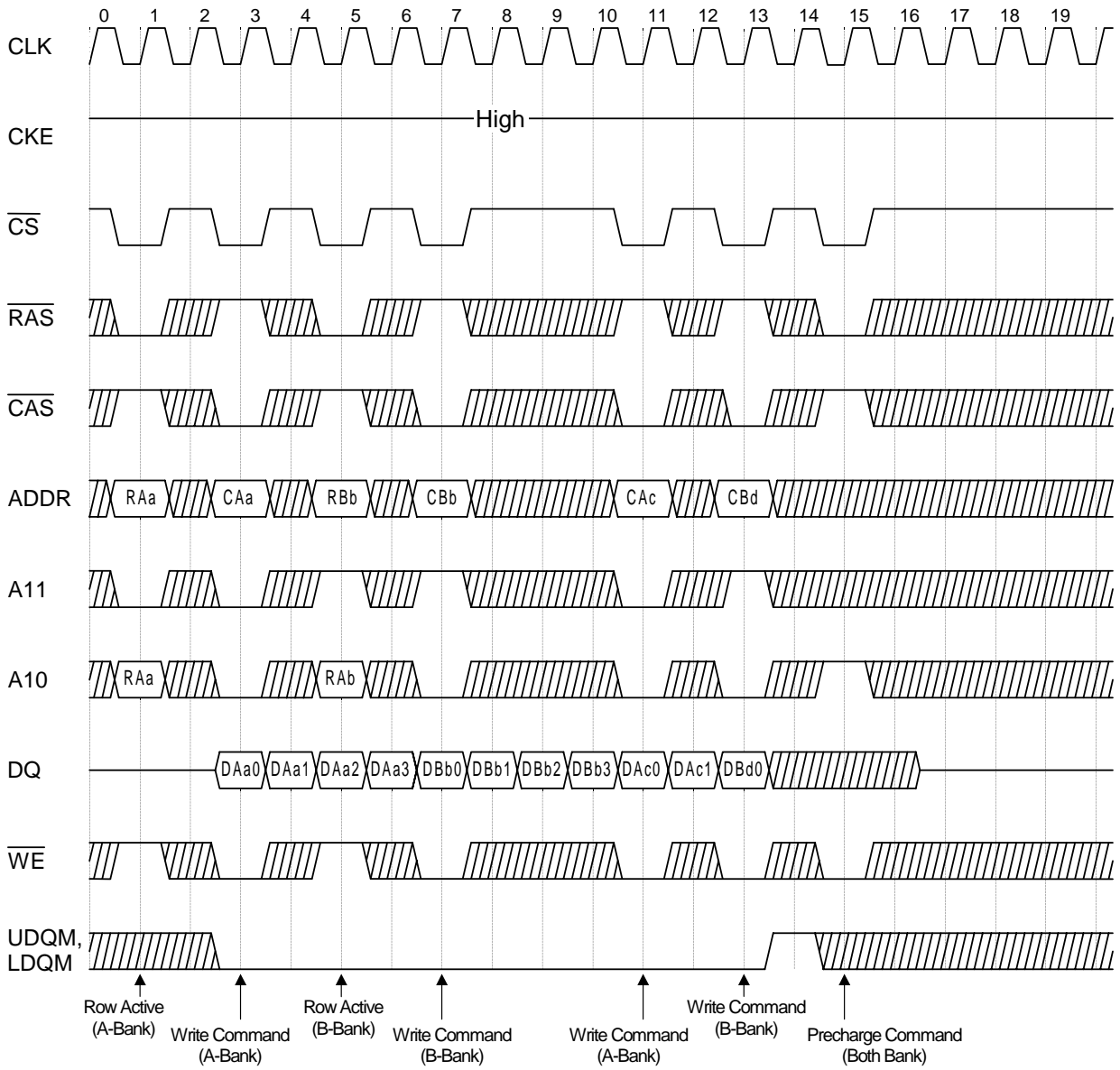

• Bank Interleave Random Row Read/Write Cycle @CAS Latency = 2, Burst Length = 4

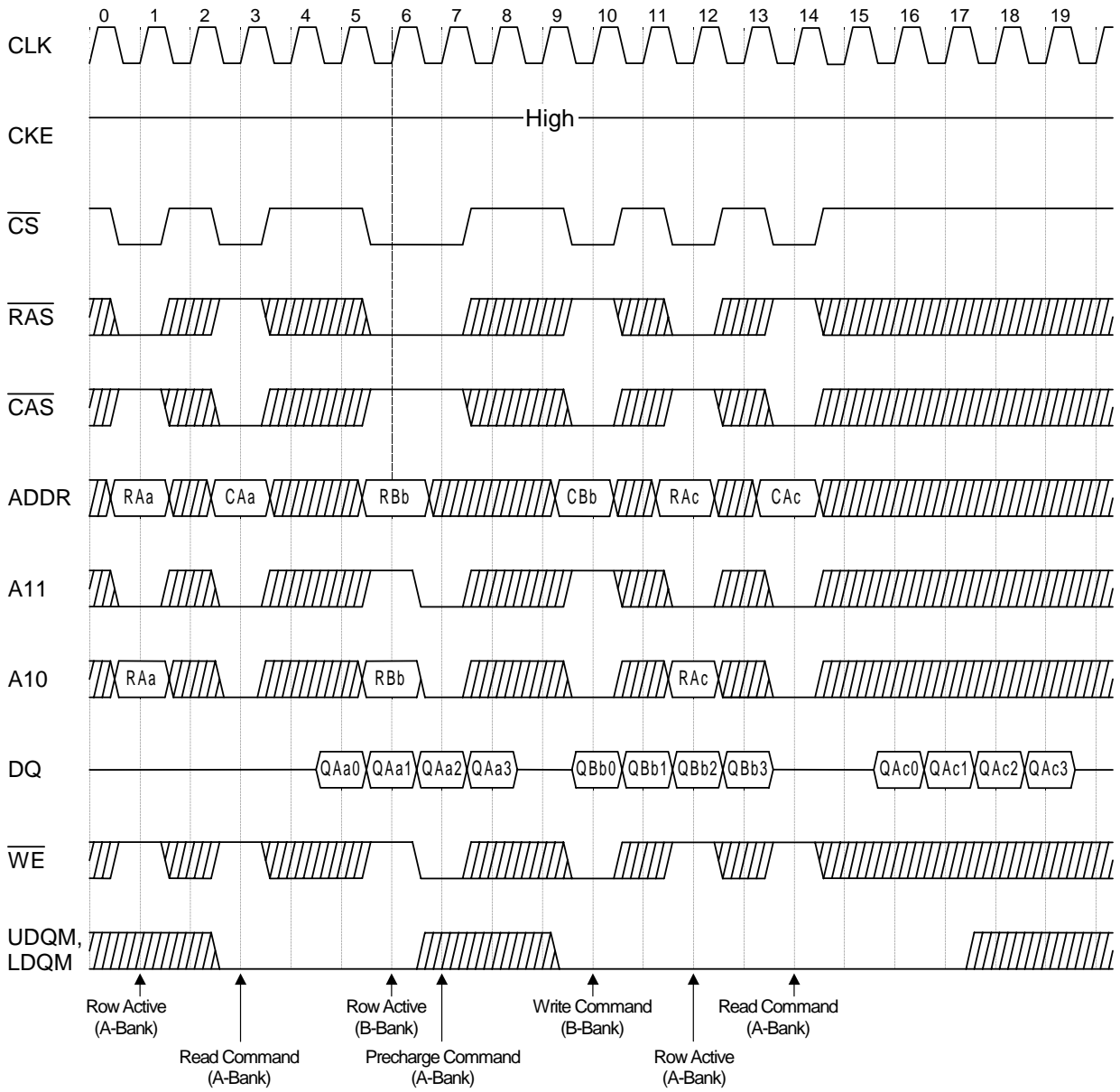

• Bank Interleave Page Read/Write Cycle @CAS Latency = 2, Burst Length =4

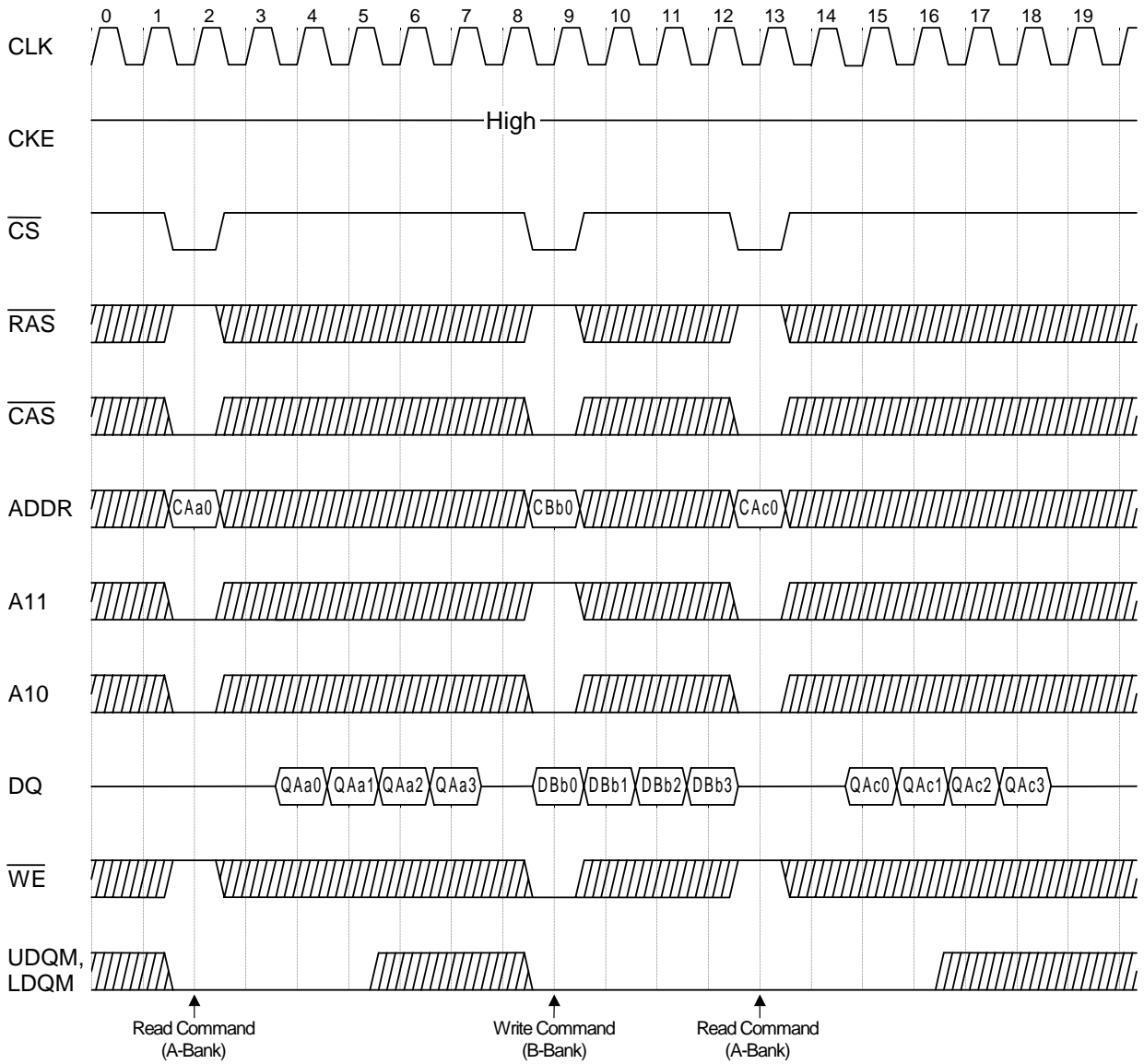

• Clock Suspension & DQM Operation Cycle @ $\overline{\text{CAS}}$ Latency = 2, Burst Length = 4

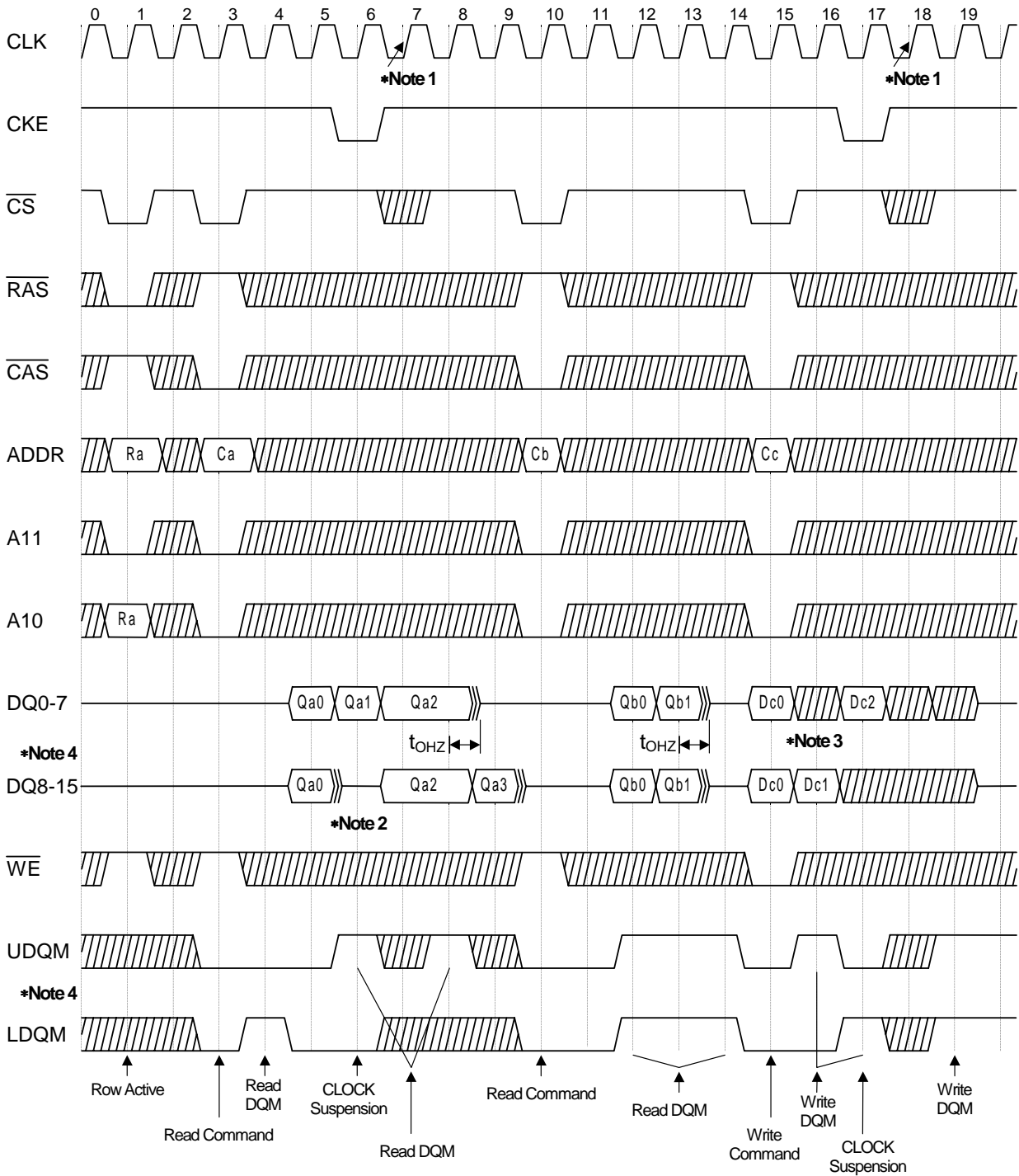

- *Notes:
1. When Clock Suspension is asserted, the next clock cycle is ignored.
 2. When LDQM and UDQM are asserted, the read data after two clock cycles is masked.
 3. When LDQM and UDQM are asserted, the write data in the same clock cycle is masked.
 4. When LDQM is set High, the input/output data of DQ0-7 is masked.
When UDQM is set High, the input/output data of DQ8-15 is masked.

• Read to Write Cycle (Same Bank) @ $\overline{\text{CAS}}$ Latency = 2, Burst Length = 4

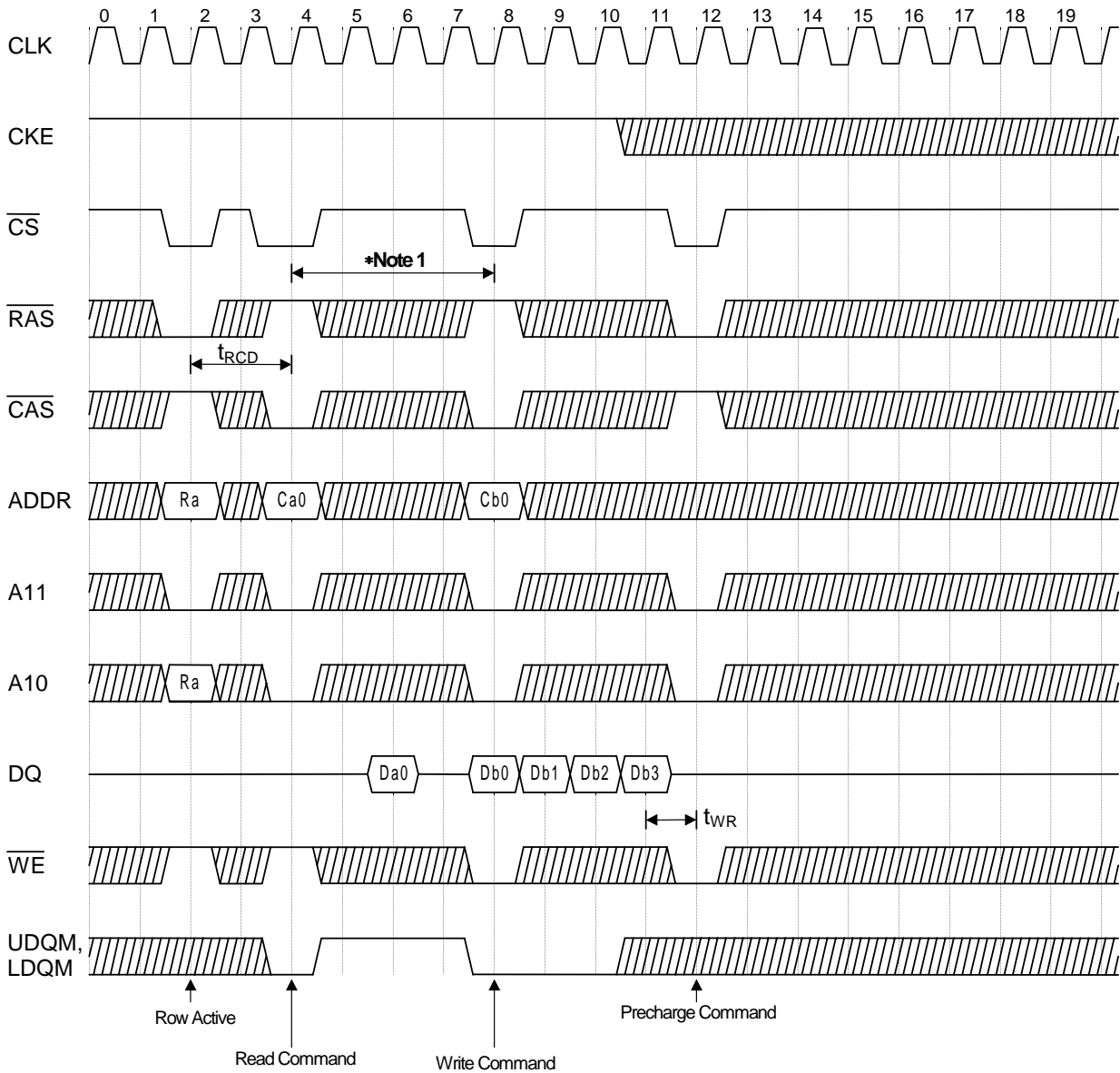

- *Note: 1. In Case $\overline{\text{CAS}}$ latency is 3, READ can be interrupted by WRITE.
 The minimum command interval is [burst length + 1] cycles.
 UDQM and LDQM must be high at least 3 clocks prior to the write command.

• Read Interruption by Precharge Command @Burst Length =8

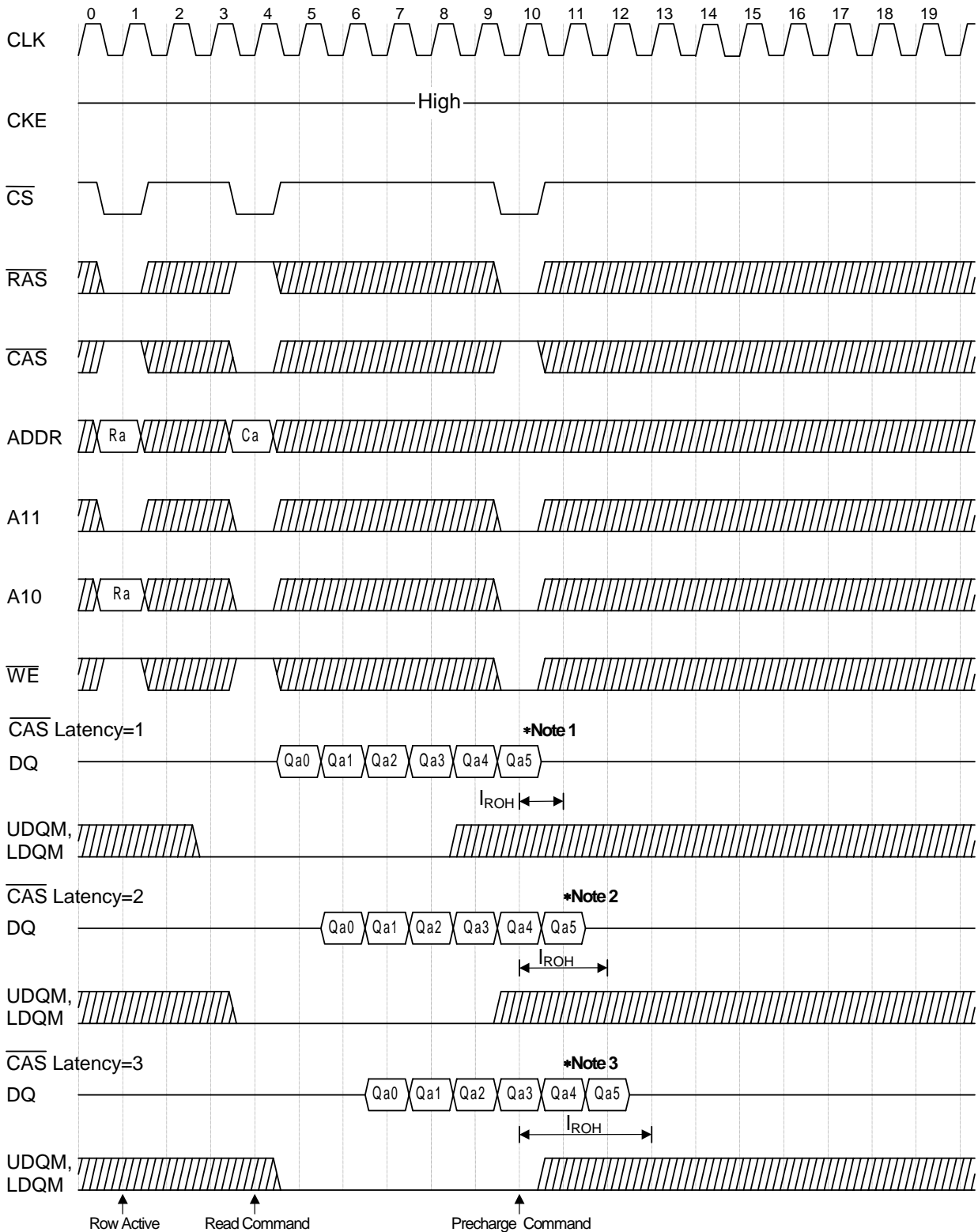

- *Notes:
1. When the $\overline{\text{CAS}}$ latency = 1, and if row precharge is asserted before a burst read ends, then the read data will not output after the next clock cycle of the precharge command.
 2. When the $\overline{\text{CAS}}$ latency = 2, and if row precharge is asserted before burst read ends, then the read data will not output after the second clock cycle of the precharge command.
 3. When the $\overline{\text{CAS}}$ latency = 3, and if row precharge is asserted before burst read ends, then the read data will not output after the second clock cycle of the precharge command.

• Burst Stop Command @Burst Length =8

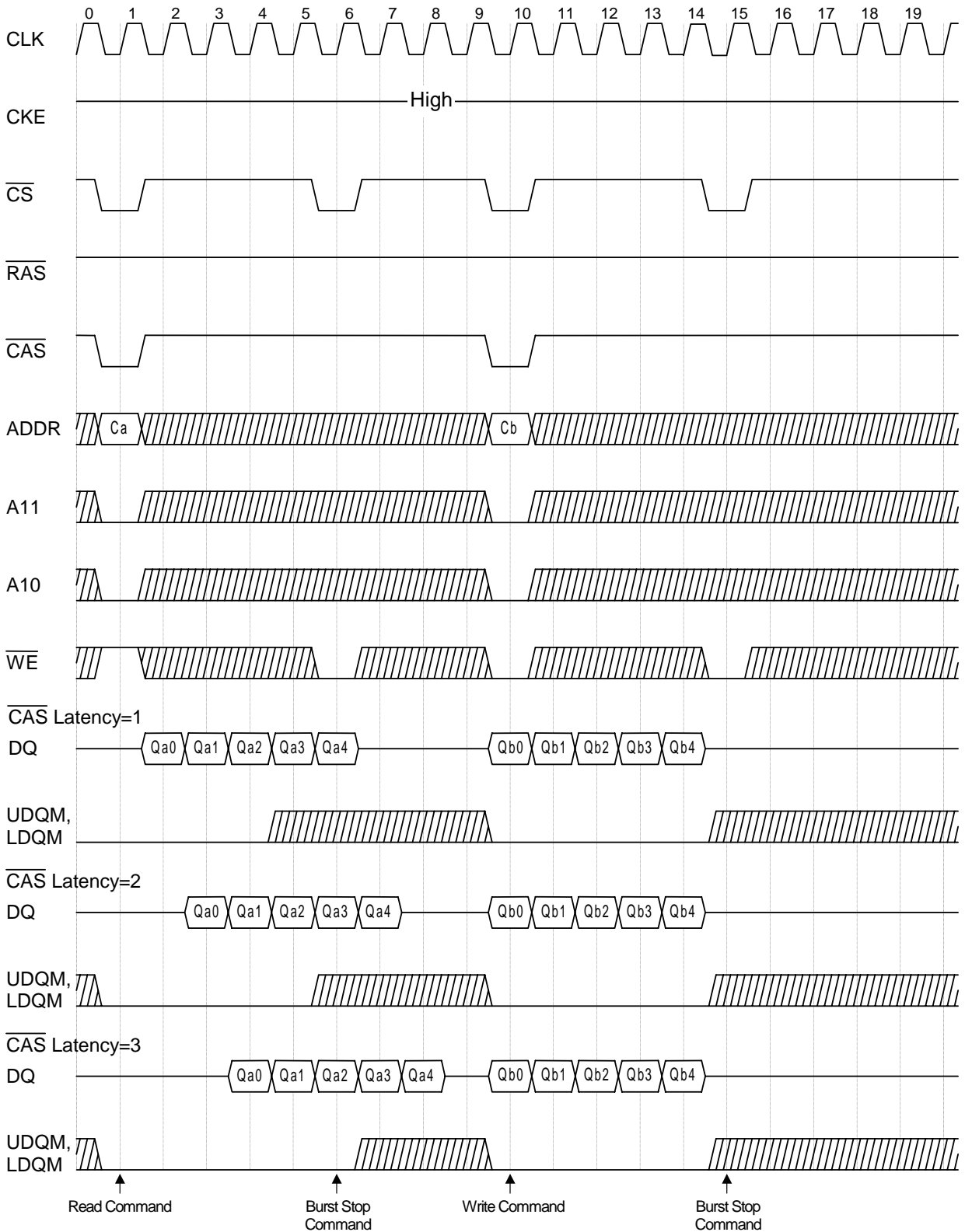

• Power Down Mode @ $\overline{\text{CAS}}$ Latency = 2, Burst Length = 4

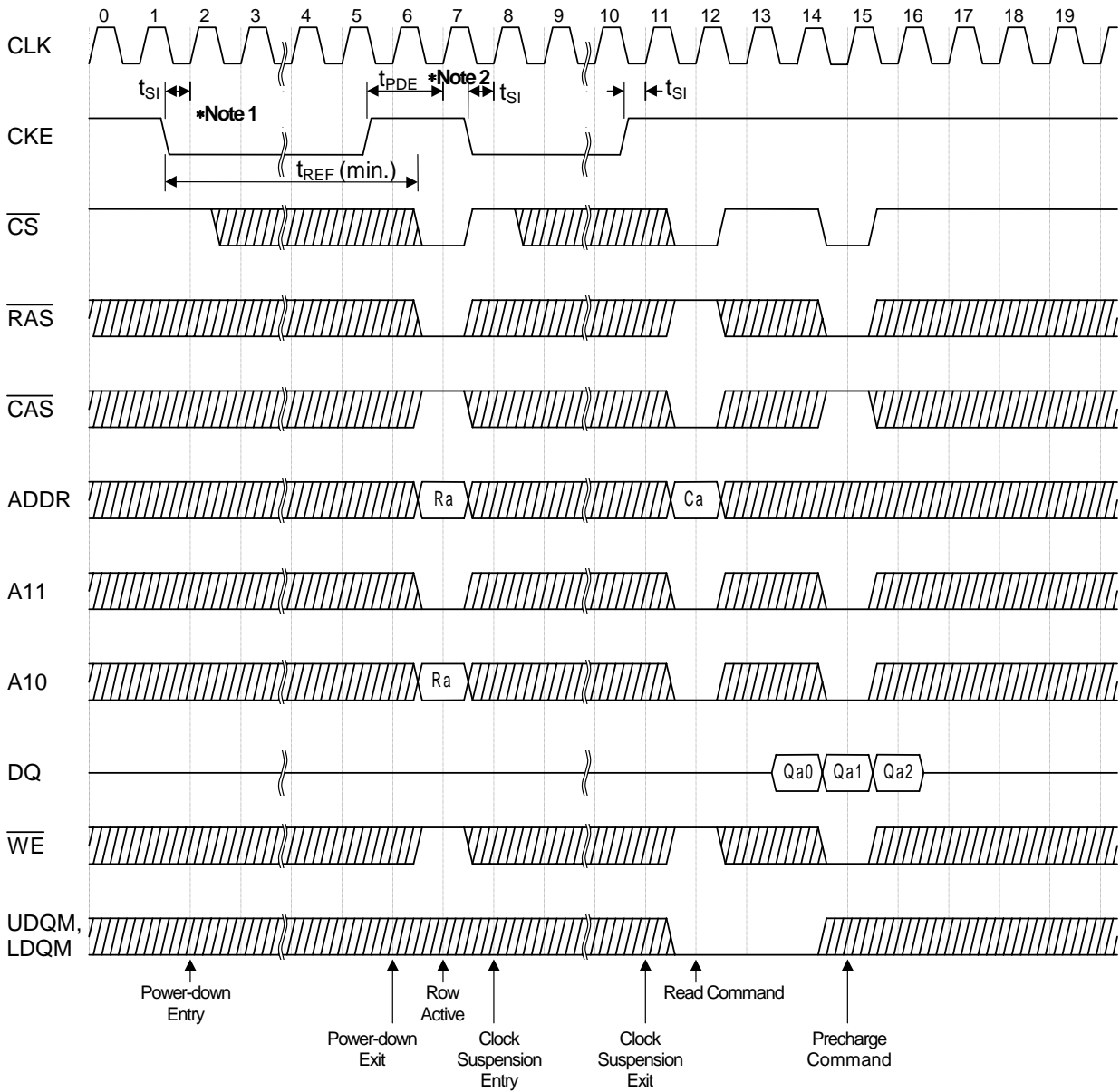

- *Notes:
1. When both banks are in precharge state, and if CKE is set low, then the MSM56V16160F enters power-down mode and maintains the mode while CKE is low.
 2. To release the circuit from power-down mode, CKE has to be set high for longer than t_{PDE} ($t_{SI} + 1\text{CLK}$).

- Self Refresh Cycle

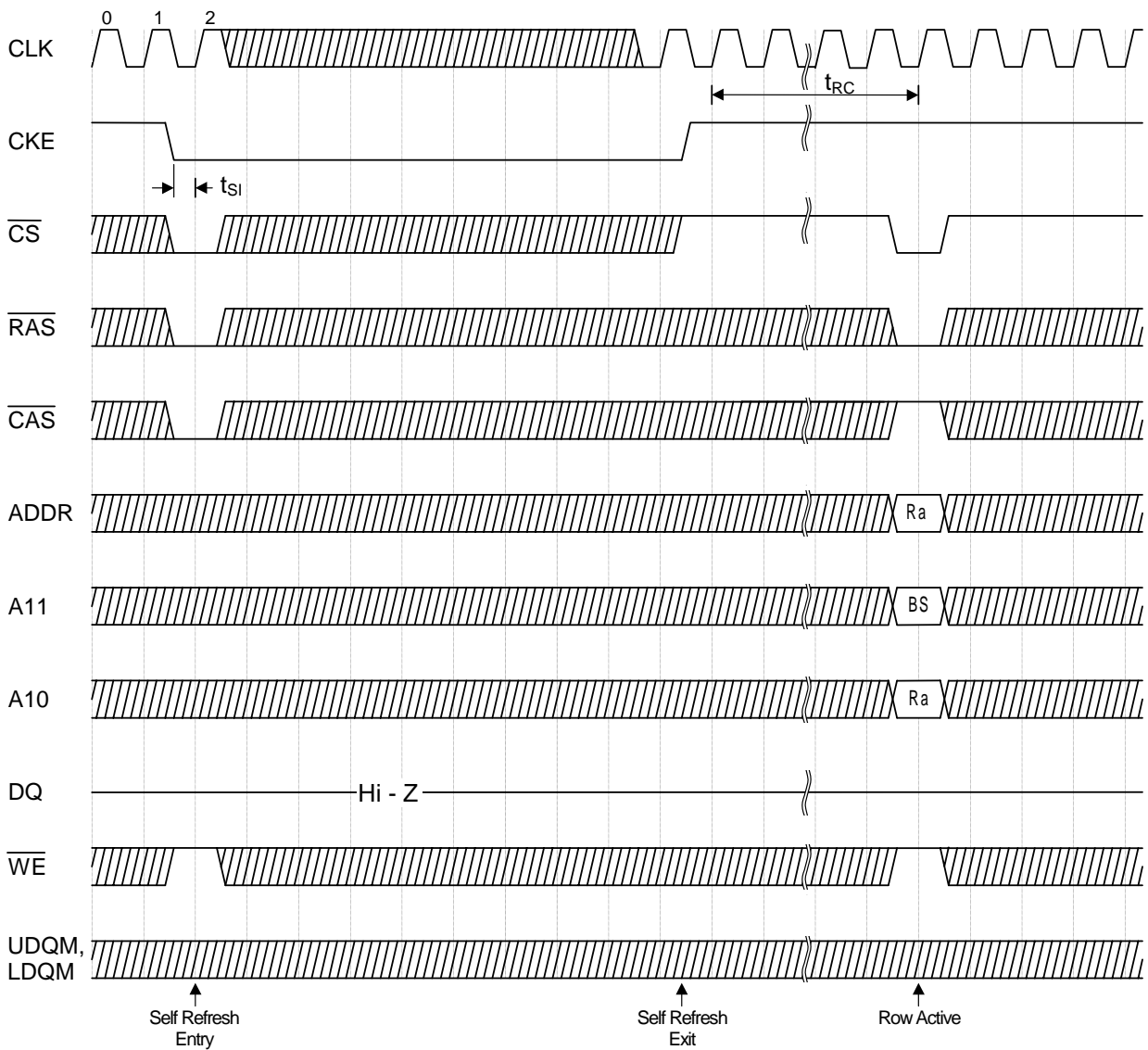

- Mode Register Set Cycle

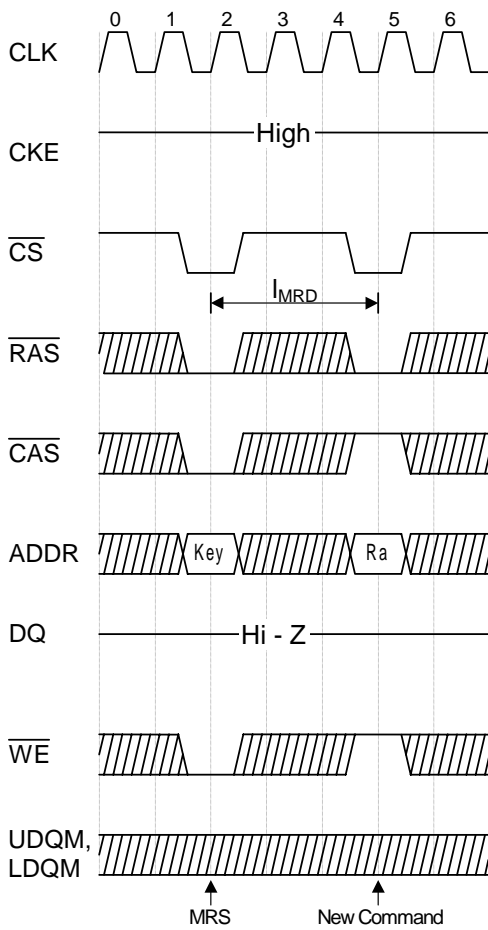

- Auto Refresh Cycle

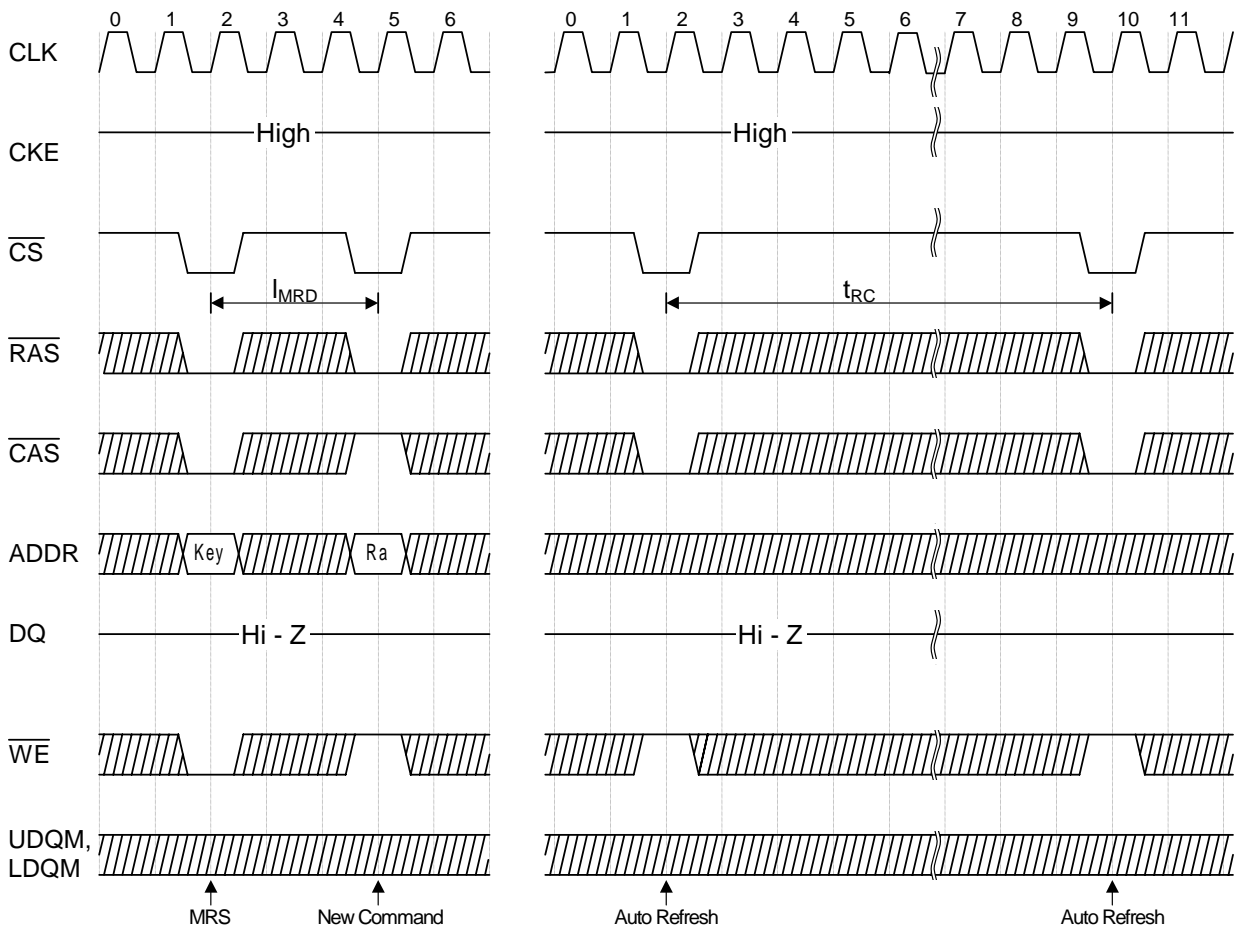

FUNCTION TRUTH TABLE (Table 1) (1/2)

Current State ¹	\overline{CS}	\overline{RAS}	\overline{CAS}	\overline{WE}	BA	ADDR	Action
Idle	H	X	X	X	X	X	NOP
	L	H	H	H	X	X	NOP
	L	H	H	L	BA	X	ILLEGAL ²
	L	H	L	X	BA	CA	ILLEGAL ²
	L	L	H	H	BA	RA	Row Active
	L	L	H	L	BA	A10	NOP ⁴
	L	L	L	H	X	X	Auto-Refresh or Self-Refresh ⁵
	L	L	L	L	L	OP Code	Mode Register Write
Row Active	H	X	X	X	X	X	NOP
	L	H	H	X	X	X	NOP
	L	H	L	H	BA	CA, A10	Read
	L	H	L	L	BA	CA, A10	Write
	L	L	H	H	BA	RA	ILLEGAL ²
	L	L	H	L	BA	A10	Precharge
	L	L	L	X	X	X	ILLEGAL
Read	H	X	X	X	X	X	NOP (Continue Row Active after Burst ends)
	L	H	H	H	X	X	NOP (Continue Row Active after Burst ends)
	L	H	H	L	X	X	Term Burst --> Row Active
	L	H	L	H	BA	CA, A10	Term Burst, start new Burst Read ³
	L	H	L	L	BA	CA, A10	Term Burst, start new Burst Write ³
	L	L	H	H	BA	RA	ILLEGAL ²
	L	L	H	L	BA	A10	Term Burst, execute Row Precharge
	L	L	L	X	X	X	ILLEGAL
Write	H	X	X	X	X	X	NOP (Continue Row Active after Burst ends)
	L	H	H	H	X	X	NOP (Continue Row Active after Burst ends)
	L	H	H	L	X	X	Term Burst --> Row Active
	L	H	L	H	BA	CA, A10	Term Burst, start new Burst Read ³
	L	H	L	L	BA	CA, A10	Term Burst, start new Burst Write ³
	L	L	H	H	BA	RA	ILLEGAL ²
	L	L	H	L	BA	A10	Term Burst, execute Row Precharge ³
	L	L	L	X	X	X	ILLEGAL
Read with Auto Precharge	H	X	X	X	X	X	NOP (Continue Burst to End and enter Row Precharge)
	L	H	H	H	X	X	NOP (Continue Burst to End and enter Row Precharge)
	L	H	H	L	BA	X	ILLEGAL ²
	L	H	L	H	BA	CA, A10	ILLEGAL ²
	L	H	L	L	X	X	ILLEGAL
	L	L	H	X	BA	RA, A10	ILLEGAL ²
	L	L	L	X	X	X	ILLEGAL
Write with Auto Precharge	H	X	X	X	X	X	NOP (Continue Burst to End and enter Row Precharge)
	L	H	H	H	X	X	NOP (Continue Burst to End and enter Row Precharge)
	L	H	H	L	BA	X	ILLEGAL ²
	L	H	L	H	BA	CA, A10	ILLEGAL ²
	L	H	L	L	X	X	ILLEGAL
	L	L	H	X	BA	RA, A10	ILLEGAL ²
	L	L	L	X	X	X	ILLEGAL

FUNCTION TRUTH TABLE (Table 1) (2/2)

Current State ¹	\overline{CS}	\overline{RAS}	\overline{CAS}	\overline{WE}	BA	ADDR	Action
Precharge	H	X	X	X	X	X	NOP --> Idle after t_{RP}
	L	H	H	H	X	X	NOP --> Idle after t_{RP}
	L	H	H	L	BA	X	ILLEGAL ²
	L	H	L	X	BA	CA	ILLEGAL ²
	L	L	H	H	BA	RA	ILLEGAL ²
	L	L	H	L	BA	A10	NOP ⁴
	L	L	L	X	X	X	ILLEGAL
Write Recovery	H	X	X	X	X	X	NOP
	L	H	H	H	X	X	NOP
	L	H	H	L	BA	X	ILLEGAL ²
	L	H	L	X	BA	CA	ILLEGAL ²
	L	L	H	H	BA	RA	ILLEGAL ²
	L	L	H	L	BA	A10	ILLEGAL ²
	L	L	L	X	X	X	ILLEGAL
Row Active	H	X	X	X	X	X	NOP --> Row Active after t_{RCD}
	L	H	H	H	X	X	NOP --> Row Active after t_{RCD}
	L	H	H	L	BA	X	ILLEGAL ²
	L	H	L	X	BA	CA	ILLEGAL ²
	L	L	H	H	BA	RA	ILLEGAL ²
	L	L	H	L	BA	A10	ILLEGAL ²
	L	L	L	X	X	X	ILLEGAL
Refresh	H	X	X	X	X	X	NOP --> Idle after t_{RC}
	L	H	H	X	X	X	NOP --> Idle after t_{RC}
	L	H	L	X	X	X	ILLEGAL
	L	L	H	X	X	X	ILLEGAL
	L	L	L	X	X	X	ILLEGAL
Mode Register Access	H	X	X	X	X	X	NOP
	L	H	H	H	X	X	NOP
	L	H	H	L	X	X	ILLEGAL
	L	H	L	X	X	X	ILLEGAL
	L	L	X	X	X	X	ILLEGAL

ABBREVIATIONS

RA = Row Address BA = Bank Address NOP = No Operation command
CA = Column Address AP = Auto Precharge

- *Notes :
1. All inputs are enabled when CKE is set high for at least 1 cycle prior to the inputs.
 2. Illegal to bank in specified state, but may be legal in some cases depending on the state of bank selection.
 3. Satisfy the timing of I_{CCD} and t_{WR} to prevent bus contention.
 4. NOP to bank precharging or in idle state. Precharges activated bank by BA or A10.
 5. Illegal if any bank is not idle.

FUNCTION TRUTH TABLE for CKE (Table 2)

Current State (n)	CKEn-1	CKEn	\overline{CS}	\overline{RAS}	\overline{CAS}	\overline{WE}	ADDR	Action
Self Refresh	H	X	X	X	X	X	X	INVALID
	L	H	H	X	X	X	X	Exit Self Refresh --> ABI
	L	H	L	H	H	H	X	Exit Self Refresh --> ABI
	L	H	L	H	H	L	X	ILLEGAL
	L	H	L	H	L	X	X	ILLEGAL
	L	H	L	L	X	X	X	ILLEGAL
	L	L	X	X	X	X	X	NOP (Maintain Self Refresh)
Power Down	H	X	X	X	X	X	X	INVALID
	L	H	H	X	X	X	X	Exit Power Down --> ABI
	L	H	L	H	H	H	X	Exit Power Down --> ABI
	L	H	L	H	H	L	X	ILLEGAL
	L	H	L	H	L	X	X	ILLEGAL
	L	H	L	L	X	X	X	ILLEGAL ⁶
	L	L	X	X	X	X	X	NOP (Continue power down mode)
All Banks Idle ⁶ (ABI)	H	H	X	X	X	X	X	Refer to Table 1
	H	L	H	X	X	X	X	Enter Power Down
	H	L	L	H	H	H	X	Enter Power Down
	H	L	L	H	H	L	X	ILLEGAL
	H	L	L	H	L	X	X	ILLEGAL
	H	L	L	L	H	L	X	ILLEGAL
	H	L	L	L	L	H	X	Enter Self Refresh
	H	L	L	L	L	L	X	ILLEGAL
	L	L	X	X	X	X	X	NOP
Any State Other than Listed Above	H	H	X	X	X	X	X	Refer to Operations in Table 1
	H	L	X	X	X	X	X	Begin Clock Suspend Next Cycle
	L	H	X	X	X	X	X	Enable Clock of Next Cycle
	L	L	X	X	X	X	X	Continue Clock Suspension

*Notes : 6. Power-down and self-refresh can be entered only when all the banks are in an idle state.

NOTICE

1. The information contained herein can change without notice owing to product and/or technical improvements. Before using the product, please make sure that the information being referred to is up-to-date.
2. The outline of action and examples for application circuits described herein have been chosen as an explanation for the standard action and performance of the product. When planning to use the product, please ensure that the external conditions are reflected in the actual circuit and assembly designs.
3. When designing your product, please use our product below the specified maximum ratings and within the specified operating ranges including, but not limited to, operating voltage, power dissipation, and operating temperature.
4. OKI assumes no responsibility or liability whatsoever for any failure or unusual or unexpected operation resulting from misuse, neglect, improper installation, repair, alteration or accident, improper handling, or unusual physical or electrical stress including, but not limited to, exposure to parameters beyond the specified maximum ratings or operation outside the specified operating range.
5. Neither indemnity against nor license of a third party's industrial and intellectual property right, etc. is granted by us in connection with the use of the product and/or information and drawings contained herein. No responsibility is assumed by us for any infringement of a third party's right which may result from the use thereof.
6. The products listed in this document are intended for use in general electronics equipment for commercial applications (e.g., office automation, communication equipment, measurement equipment, consumer electronics, etc.). These products are not authorized for use in any system or application that requires special or enhanced quality and reliability characteristics nor in any system or application where the failure of such system or application may result in the loss or damage of property, or death or injury to humans. Such applications include, but are not limited to: traffic control, automotive, safety, aerospace, nuclear power control, and medical, including lift support and maintenance.
7. Certain products in this document may need government approval before they can be exported to particular countries. The purchaser assumes the responsibility of determining the legality of export of these products and will take appropriate and necessary steps at their own expense for these.
8. No part of the contents contained herein may be reprinted or reproduced without our prior permission.

Copyright 1997 OKI ELECTRIC INDUSTRY CO.,LTD.
