

CD4013A Types

Dual 'D'-Type Flip-Flop

The RCA-CD4013A consists of two identical, independent data-type flip-flops. Each flip-flop has independent data, set, reset, and clock inputs, and Q and Q outputs. These devices can be used for shift register applications, and by connecting Q output to the data input, for counter and toggle applications. The logic level present at the D input is transferred to the Q output during the positive-going transition of the clock pulse.

Setting or resetting is independent of the clock and is accomplished by a high level on the set (with low-level on reset) or reset (with low-level on set) line, respectively.

These types are supplied in 14-lead hermetic dual-in-line ceramic packages (D and F suffixes), 14-lead dual-in-line plastic packages (E suffix), 14-lead ceramic flat packages (K suffix), and in chip form (H suffix).

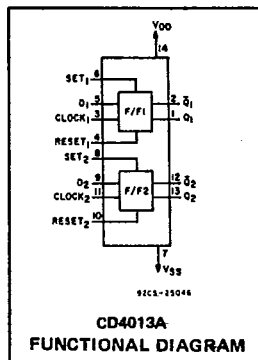

MAXIMUM RATINGS, Absolute-Maximum Values:

STORAGE-TEMPERATURE RANGE (T <sub>stg</sub> )	-65 to +150°C
OPERATING-TEMPERATURE RANGE (T <sub>A</sub> ):	
PACKAGE TYPES D, F, K, H	-55 to +125°C
PACKAGE TYPE: E	-40 to +85°C
DC SUPPLY-VOLTAGE RANGE, (V <sub>DD</sub> )	
(Voltages referenced to V <sub>SS</sub> Terminal)	-0.5 to +15 V
POWER DISSIPATION PER PACKAGE (P <sub>D</sub> ):	
FOR T <sub>A</sub> = -40 to +60°C (PACKAGE TYPE E)	500 mW
FOR T <sub>A</sub> = +60 to +85°C (PACKAGE TYPE E)	Derate Linearly at 12 mW/°C to 200 mW
FOR T <sub>A</sub> = -55 to +100°C (PACKAGE TYPES D, F, K)	500 mW
FOR T <sub>A</sub> = +100 to +125°C (PACKAGE TYPES D, F, K)	Derate Linearly at 12 mW/°C to 200 mW
DEVICE DISSIPATION PER OUTPUT TRANSISTOR	
FOR T <sub>A</sub> = FULL PACKAGE-TEMPERATURE RANGE (ALL PACKAGE TYPES)	100 mW
INPUT VOLTAGE RANGE, ALL INPUTS	-0.5 to V <sub>DD</sub> +0.5 V
LEAD TEMPERATURE (DURING SOLDERING):	
At distance 1/16 ± 1/32 inch (1.59 ± 0.79 mm) from case for 10 s max.	+265°C

Features:

- Set-Reset capability
- Static flip-flop operation — retains state indefinitely with clock level either "high" or "low"
- Medium-speed operation — 10 MHz (typ.) clock toggle rate at 10 V
- Quiescent current specified to 15 V
- Maximum input leakage of 1 μA at 15 V (full package-temperature range)
- 1-V noise margin (full package-temperature range)

Applications:

- Registers, counters, control circuits

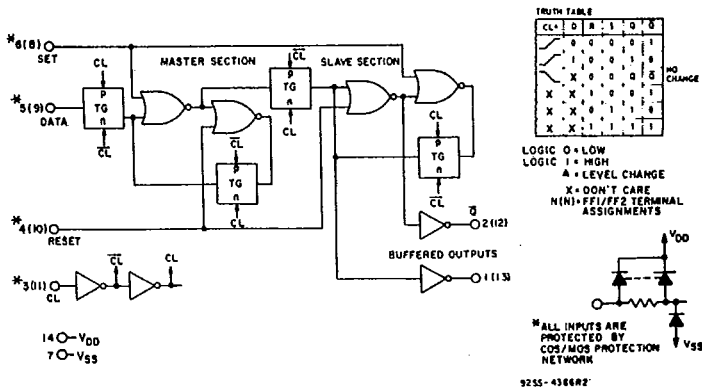

Fig. 1 — Logic diagram and truth table for CD4013A (one of two identical flip flops).

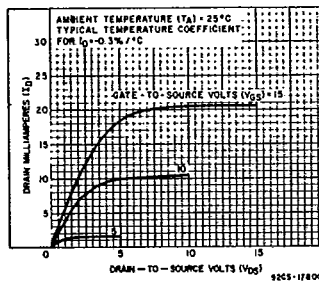

Fig. 2 — Typical n-channel drain characteristics.

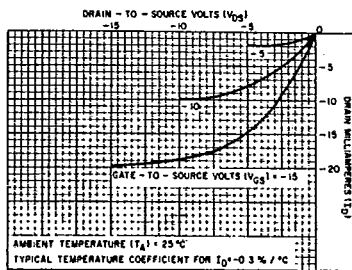

Fig. 3 — Typical p-channel drain characteristics.

**CD4013A Types**

**RECOMMENDED OPERATING CONDITIONS at  $T_A = 25^\circ\text{C}$ , Except as Noted:**  
 For maximum reliability, nominal operating conditions should be selected so that operation is always within the following ranges —

CHARACTERISTIC	VDD (V)	LIMITS				UNITS
		D,F,K,H Packages		E Package		
		Min.	Max.	Min.	Max.	
Supply-Voltage Range (For $T_A =$ Full Package Temperature Range)	—	3	12	3	12	V
Data Setup Time $t_S$	5 10	40 20	—	50 25	—	ns
Clock Pulse Width $t_W$	5 10	200 80	—	500 100	—	ns
Clock Input Frequency $f_{CL}$	5 10	dc	2.5 7	dc	1 5	MHz
Clock Rise or Fall Time $t_{rCL}, t_{fCL}$	5 10	—	15 5	—	15 5	$\mu\text{s}$
Set or Reset Pulse Width	5 10	250 100	—	500 125	—	ns

\* If more than one unit is cascaded in a parallel clocked operation,  $t_{rCL}$  should be made less than or equal to the sum of the fixed propagation delay time at 15 pF and the transition time of the output driving stage for the estimated capacitive load.

**DYNAMIC ELECTRICAL CHARACTERISTICS at  $T_A = 25^\circ\text{C}$ , Input  $t_r, t_f = 20$  ns,  $C_L = 15$  pF,  $R_L = 200$  k $\Omega$**

CHARACTERISTIC	VDD (V)	LIMITS						UNITS
		D,F,K,H Packages			E Package			
		Min.	Typ.	Max.	Min.	Typ.	Max.	
Propagation Delay Time: Clock to Q or $\bar{Q}$ Outputs $t_{PHL}, t_{PLH}$	5 10	—	150 75	300 110	—	150 75	350 125	ns
Set to Q or Reset to $\bar{Q}$ $t_{PLH}$	5 10	—	175 75	300 110	—	175 75	350 125	ns
Set to $\bar{Q}$ or Reset to Q $t_{PHL}$	5 10	—	175 75	300 110	—	175 75	350 125	ns
Transition Time, $t_{THL}, t_{TLH}$	5 10	—	75 60	125 70	—	75 50	150 75	ns
Maximum Clock Input Frequency, $f_{CL}$	5 10	2.5 7	4 10	—	1 5	4 10	—	MHz
Minimum Clock Pulse Width, $t_W$	5 10	—	125 50	200 80	—	125 50	500 100	ns
Minimum Set or Reset Pulse Width, $t_W$	5 10	—	125 50	250 100	—	125 50	500 125	ns
Minimum Data Setup Time, $t_S$	5 10	—	20 10	40 20	—	20 10	50 25	ns
Clock Rise or Fall Time $t_{rCL}, t_{fCL}$	5 10	—	— —	15 5	—	— —	15 5	$\mu\text{s}$
Average Input Capacitance, $C_i$	Any Input	—	5	—	—	5	—	pF

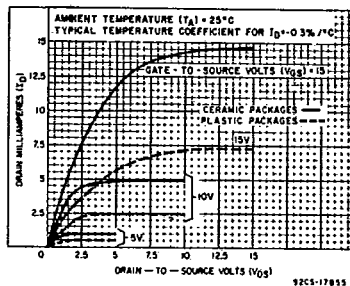

Fig.4 — Minimum n-channel drain characteristics.

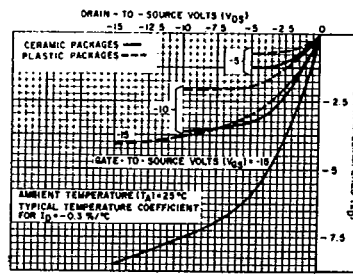

Fig.5 — Minimum p-channel drain characteristics.

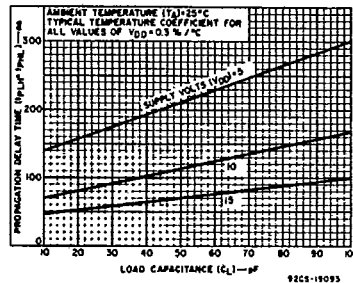

Fig.6 — Typical propagation delay time vs.  $C_L$ .

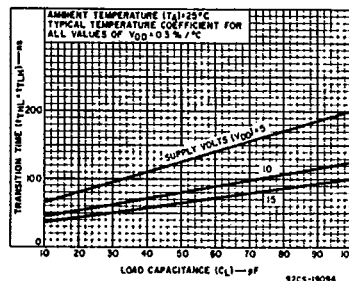

Fig.7 — Typical transition time vs.  $C_L$ .

CD4013A Types

STATIC ELECTRICAL CHARACTERISTICS

Characteristic	Conditions			Limits at Indicated Temperatures (°C)									Units
				D, F, K, H Packages						E Package			
				-55	+25		+125	-40	+25		+85		
V <sub>O</sub> (V)	V <sub>IN</sub> (V)	V <sub>DD</sub> (V)	Typ.	Limit	Typ.	Limit	Typ.	Limit	Typ.	Limit			
Quiescent Device Current, I <sub>L</sub> Max.	-	-	5	1	0.005	1	60	10	0.01	10	140	μA	
	-	-	10	2	0.005	2	120	20	0.02	20	280		
	-	-	15	25	0.5	25	1000	250	2.5	250	2500		
Output Voltage: Low-Level, V <sub>OL</sub>	-	0.5	5	0 Typ.; 0.05 Max.									V
	-	0.10	10	0 Typ.; 0.05 Max.									
	-	0.5	5	5 Typ.; 4.95 Min.									
High-Level, V <sub>OH</sub>	-	0.10	10	10 Typ.; 9.95 Min.									V
	-	0.10	10	10 Typ.; 9.95 Min.									
Noise Immunity: Inputs Low, V <sub>NL</sub>	4.2	-	5	2.25 Typ.; 1.5 Min.									V
	9	-	10	4.5 Typ.; 3 Min.									
Inputs High, V <sub>NH</sub>	0.8	-	5	2.25 Typ.; 1.5 Min.									V
	1	-	10	4.5 Typ.; 3 Min.									
Noise Margin: Inputs Low, V <sub>NML</sub>	4.5	-	5	1 Min.									V
	9	-	10	1 Min.									
	0.5	-	5	1 Min.									
Inputs High, V <sub>NMH</sub>	1	-	10	1 Min.									V
	1	-	10	1 Min.									
Output Drive Current: N-Channel (Sink), I <sub>DN</sub> Min.	0.5	-	5	0.65	1	0.5	0.35	0.35	1	0.3	0.24	mA	
	0.5	-	10	1.25	2.5	1	0.75	0.72	2.5	0.6	0.5		
P-Channel (Source), I <sub>DP</sub> Min.	4.5	-	5	-0.31	-0.5	-0.25	-0.175	-0.17	-0.5	-0.14	-0.12	mA	
	9.5	-	10	-0.8	-1.3	-0.65	-0.45	-0.4	-1.3	-0.33	-0.27		
Input Leakage Current, I <sub>IL</sub> , I <sub>IH</sub>	Any Input		15	±10 <sup>-5</sup> Typ.; ±1 Max.									μA

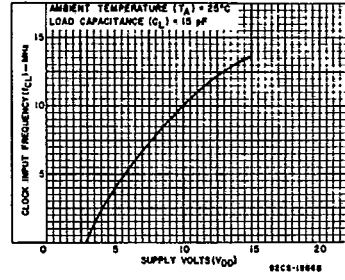

Fig. 8 - Typical maximum clock input frequency vs. V<sub>DD</sub>.

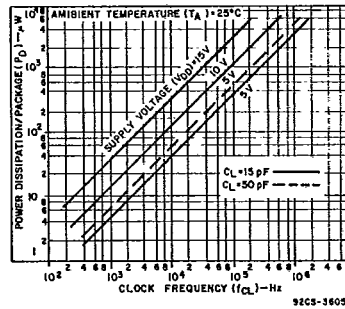

Fig. 9 - Typical dissipation characteristics.

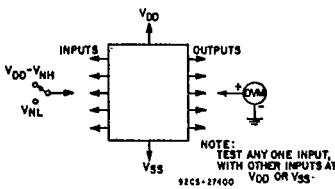

Fig. 10 - Noise immunity test circuit.

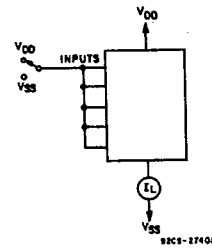

Fig. 12 - Quiescent device-current test circuit.

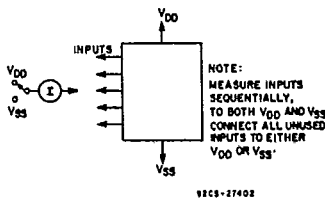

Fig. 11 - Input leakage test circuit.

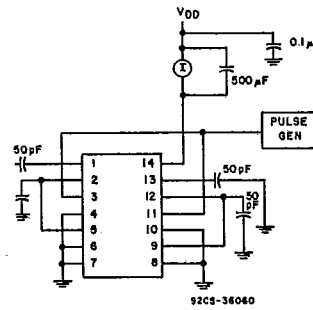
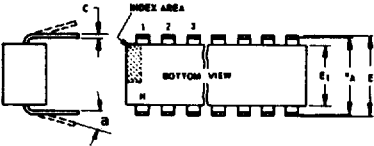
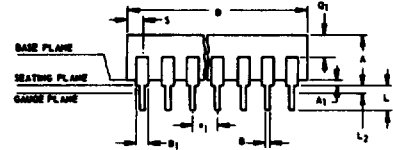

Fig. 13 - Dynamic power dissipation test circuit.

## Dimensional Outlines

### Dual-In-Line Welded-Seal Ceramic Packages



NOTES:  
Refer to Rules for Dimensioning (JEDEC Publication No. 95) for Axial Lead Product Outlines.

- When this device is supplied solder-dipped, the maximum lead thickness (narrow portion) will not exceed 0.013" (0.33 mm).
- Leads within 0.005" (0.12 mm) radius of True Position (TP) at gauge plane with maximum material condition and unit installed.
- $e_A$  applies in zone  $L_2$  when unit installed.
- $a$  applies to spread leads prior to installation.
- $N$  is the maximum quantity of lead positions.
- $N_1$  is the quantity of allowable missing leads.

(D) SUFFIX (JEDEC MO-001-AD)  
14-Lead Dual-In-Line Welded-Seal Ceramic Package

SYMBOL	INCHES		NOTE	MILLIMETERS	
	MIN.	MAX.		MIN.	MAX.
A	0.120	0.160		3.05	4.06
A <sub>1</sub>	0.020	0.065		0.51	1.65
B	0.014	0.020		0.356	0.508
B <sub>1</sub>	0.060	0.065		1.27	1.65
C	0.008	0.012	1	0.204	0.304
D	0.745	0.770		18.93	19.55
E	0.300	0.325		7.62	8.25
E <sub>1</sub>	0.240	0.260		6.10	6.60
$e_1$	0.100 TP		2	2.54 TP	
$e_A$	0.300 TP		2, 3	7.62 TP	
L	0.125	0.150		3.18	3.81
L <sub>2</sub>	0.000	0.030		0.000	0.76
a	0°	15°	4	0°	15°
N	14		5	14	
N <sub>1</sub>	0		6	0	
Q <sub>1</sub>	0.050	0.085		1.27	2.15
S	0.065	0.090		1.66	2.28

92SS-4411R2

(D) SUFFIX (JEDEC MO-001-AE)  
16-Lead Dual-In-Line Welded-Seal Ceramic Package

SYMBOL	INCHES		NOTE	MILLIMETERS	
	MIN.	MAX.		MIN.	MAX.
A	0.120	0.160		3.05	4.06
A <sub>1</sub>	0.020	0.065		0.51	1.65
B	0.014	0.020		0.356	0.508
B <sub>1</sub>	0.035	0.065		0.89	1.65
C	0.008	0.012	1	0.204	0.304
D	0.745	0.785		18.93	19.93
E	0.300	0.325		7.62	8.25
E <sub>1</sub>	0.240	0.260		6.10	6.60
$e_1$	0.100 TP		2	2.54 TP	
$e_A$	0.300 TP		2, 3	7.62 TP	
L	0.125	0.150		3.18	3.81
L <sub>2</sub>	0.000	0.030		0.000	0.76
a	0°	15°	4	0°	15°
N	16		5	16	
N <sub>1</sub>	0		6	0	
Q <sub>1</sub>	0.050	0.085		1.27	2.15
S	0.015	0.060		0.39	1.52

92SS-4266R5

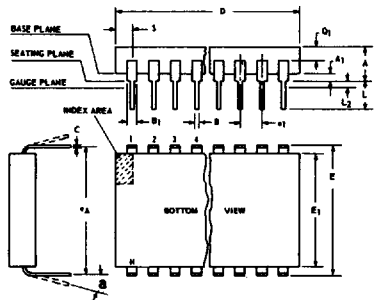

NOTES:  
Refer to Rules for Dimensioning (JEDEC Publication No. 95) for Axial Lead Product Outlines.

- When this device is supplied solder-dipped, the maximum lead thickness (narrow portion) will not exceed 0.013" (0.33 mm).
- Leads within 0.005" (0.12 mm) radius of True Position (TP) at gauge plane with maximum material condition and unit installed.
- $e_A$  applies in zone  $L_2$  when unit installed.
- $a$  applies to spread leads prior to installation.
- $N$  is the maximum quantity of lead positions.
- $N_1$  is the quantity of allowable missing leads.

(D) SUFFIX (JEDEC MO-015-AG)  
24-Lead Dual-In-Line Welded-Seal Ceramic Package

SYMBOL	INCHES		NOTE	MILLIMETERS	
	MIN.	MAX.		MIN.	MAX.
A	0.090	0.200		2.29	5.08
A <sub>1</sub>	0.020	0.070		0.51	1.78
B	0.015	0.020		0.381	0.508
B <sub>1</sub>	0.045	0.055		1.143	1.397
C	0.008	0.012	1	0.204	0.304
D	1.15	1.22		29.21	30.98
E	0.600	0.625		15.24	15.87
E <sub>1</sub>	0.480	0.520		12.20	13.20
$e_1$	0.100 TP		2	2.54 TP	
$e_A$	0.600 TP		2, 3	15.24 TP	
L	0.100	0.180		2.54	4.57
L <sub>2</sub>	0.000	0.030		0.00	0.76
a	0°	15°	4	0°	15°
N	24		5	24	
N <sub>1</sub>	0		6	0	
Q <sub>1</sub>	0.020	0.080		0.51	2.03
S	0.020	0.060		0.51	1.52

92CS-19948R4

(D) SUFFIX (JEDEC MO-015-AH)  
28-Lead Dual-In-Line Welded-Seal Ceramic Package

SYMBOL	INCHES		NOTE	MILLIMETERS	
	MIN.	MAX.		MIN.	MAX.
A	0.090	0.200		2.29	5
A <sub>1</sub>	0	0.070	2	0	1.77
B	0.015	0.020		0.381	0.508
B <sub>1</sub>	0.015	0.065		0.39	1.39
C	0.008	0.012	1	0.204	0.304
D	1.380	1.420		35.06	36.06
E	0.600	0.625		15.24	15.87
E <sub>1</sub>	0.485	0.515		12.32	13.08
$e_1$	0.100 TP		2	2.54 TP	
$e_A$	0.600 TP		2, 3	15.24 TP	
L	0.100	0.200		2.6	5
L <sub>2</sub>	0	0.030		0	0.76
a	0°	15°	4	0°	15°
N	28		5	28	
N <sub>1</sub>	0		6	0	
Q <sub>1</sub>	0.020	0.070		0.51	1.77
S	0.040	0.070		1.02	1.77

92CM-20250R2

### TO-5 Style Package

(T) SUFFIX (JEDEC MO-006-AG)  
12-Lead Metal Package

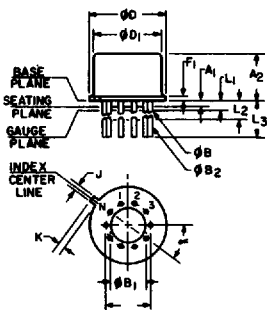

92CS-19774

SYMBOL	INCHES		NOTE	MILLIMETERS	
	MIN.	MAX.		MIN.	MAX.
a	0.230		2	5.84 TP	
A <sub>1</sub>	0	0		0	0
A <sub>2</sub>	0.165	0.185		4.19	4.70
$\phi B$	0.016	0.019	3	0.407	0.482
$\phi B_1$	0	0		0	0
$\phi B_2$	0.016	0.021	3	0.407	0.533
$\phi D$	0.335	0.370		8.51	9.39
$\phi D_1$	0.305	0.335		7.75	8.50
F <sub>1</sub>	0.020	0.040		0.51	1.01
j	0.028	0.034		0.712	0.863
k	0.029	0.045	4	0.74	1.14
L <sub>1</sub>	0.000	0.050	3	0.00	1.27
L <sub>2</sub>	0.250	0.500	3	6.4	12.7
L <sub>3</sub>	0.500	0.562	3	12.7	14.27
a	30° TP			30° TP	
N	12		6	12	
N <sub>1</sub>	1		5	1	

NOTES:

- Refer to Rules for Dimensioning Axial Lead Product Outlines.
- Leads at gauge plane within 0.007" (0.178 mm) radius of True Position (TP) at maximum material condition.
- $\phi B$  applies between L<sub>1</sub> and L<sub>2</sub>.  $\phi B_2$  applies between L<sub>2</sub> and 0.500" (12.70 mm) from seating plane. Diameter is uncontrolled in L<sub>1</sub> and beyond 0.500" (12.70 mm).
- Measure from Max.  $\phi D$ .
- $N_1$  is the quantity of allowable missing leads.
- $N$  is the maximum quantity of lead positions.

Dimensional Outlines (Cont'd)

DUAL-IN-LINE SIDE-BRAZED CERAMIC PACKAGES

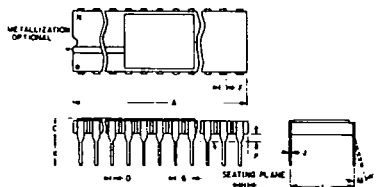

(D) SUFFIX  
18-Lead Dual-In-Line  
Side-Brazed Ceramic Package

SYMBOL	INCHES		NOTE	MILLIMETERS	
	MIN.	MAX.		MIN.	MAX.
A	0.890	0.915		22.606	23.241
C	-	0.200		-	5.080
D	0.015	0.021		0.381	0.533
F	0.054	REF.	1	1.371	REF.
G	0.100	BSC	1	2.54	BSC
H	0.035	0.065		0.889	1.651
J	0.008	0.012	3	0.203	0.304
K	0.125	0.150		3.175	3.810
L	0.290	0.310	2	7.366	7.874
M	0°	15°		0°	15°
P	0.025	0.045		0.635	1.143
N	18			18	

92CS-27231R1

(D) SUFFIX  
22-Lead Dual-In-Line  
Side-Brazed Ceramic Package

SYMBOL	INCHES		NOTE	MILLIMETERS	
	MIN.	MAX.		MIN.	MAX.
A	1.065	1.100		27.05	27.94
C	0.085	0.145		2.16	3.68
D	0.017	0.023		0.43	0.58
F	0.040	REF.	1	1.02	REF.
G	0.100	BSC	1	2.54	BSC
H	0.030	0.070		0.76	1.78
J	0.008	0.012	3	0.20	0.30
K	0.125	0.175		3.18	4.45
L	0.380	0.420	2	9.65	10.67
M	-	7°		-	7°
P	0.025	0.050		0.64	1.27
N	22			22	

92CS-25186R2

NOTES:

- Leads within 0.005" (0.13 mm) radius of True Position at maximum material condition.
- Dimension "L" to center of leads when formed parallel.
- When this device is supplied solder-dipped, the maximum lead thickness (narrow portion) will not exceed 0.013" (0.33 mm).

(D) SUFFIX  
24-Lead Dual-In-Line  
Side-Brazed Ceramic Package

SYMBOL	INCHES		NOTE	MILLIMETERS	
	MIN.	MAX.		MIN.	MAX.
A	1.180	1.220		29.98	30.98
C	0.085	0.145		2.16	3.68
D	0.015	0.023		0.39	0.58
F	0.040	REF.		1.02	REF.
G	0.100	BSC	1	2.54	BSC
H	0.030	0.070		0.77	1.77
J	0.008	0.012	3	0.21	0.30
K	0.125	0.175		3.18	4.44
L	0.580	0.620	2	14.74	15.74
M	-	7°		-	7°
P	0.025	0.050		0.64	1.27
N	24			24	

92CS-30968R1

(D) SUFFIX  
40-Lead Dual-In-Line  
Side-Brazed Ceramic Package

SYMBOL	INCHES		NOTE	MILLIMETERS	
	MIN.	MAX.		MIN.	MAX.
A	1.980	2.020		50.30	51.30
C	0.095	0.155		2.43	3.93
D	0.017	0.023		0.43	0.58
F	0.050	REF.		1.27	REF.
G	0.100	BSC	1	2.54	BSC
H	0.030	0.070		0.76	1.78
J	0.008	0.012	3	0.20	0.30
K	0.125	0.175		3.18	4.45
L	0.580	0.620	2	14.74	15.74
M	-	7°		-	7°
P	0.025	0.050		0.64	1.27
N	40			40	

92CM-27029R2

Dual-In-Line Plastic and Frit-Seal Ceramic Packages

(E) SUFFIX (JEDEC MO-001-AN)  
8-Lead Dual-In-Line Plastic  
(Mini-DIP) Package

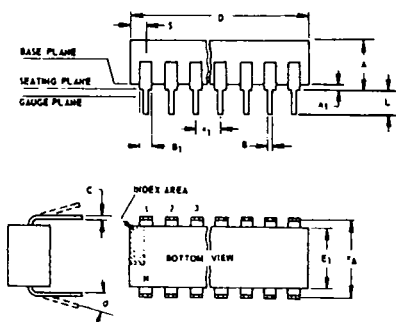

SYMBOL	INCHES		NOTE	MILLIMETERS	
	MIN.	MAX.		MIN.	MAX.
A	0.155	0.200		3.94	5.08
A <sub>1</sub>	0.020	0.050		0.508	1.27
B	0.014	0.020		0.356	0.508
B <sub>1</sub>	0.035	0.065		0.889	1.65
C	0.008	0.012	1	0.203	0.304
D	0.370	0.400		9.40	10.16
E	0.300	0.325		7.62	8.25
E <sub>1</sub>	0.240	0.260		6.10	6.60
e <sub>1</sub>	0.100	TP	2	2.54	TP
e <sub>A</sub>	0.300	TP	2, 3	7.62	TP
L	0.125	0.150		3.18	3.81
L <sub>2</sub>	0.000	0.030		0.000	0.762
a	0	15	4	0	15
N	8		5	8	
N <sub>1</sub>	0		6	0	
O <sub>1</sub>	0.040	0.075		1.02	1.90
S	0.015	0.060		0.381	1.52

92CS-24026 R1

NOTES:

- Refer to Rules for Dimensioning (JEDEC Publication No. 95) for Axial Lead Product Outlines.
- When this device is supplied solder-dipped, the maximum lead thickness (narrow portion) will not exceed 0.013".
  - Leads within 0.005" (0.12 mm) radius of True Position (TP) at gauge plane with maximum material condition and unit installed.
  - e<sub>A</sub> applies in zone L<sub>2</sub> when unit installed.
  - a applies to spread leads prior to installation.
  - N is the maximum quantity of lead positions.
  - N<sub>1</sub> is the quantity of allowable missing leads.

Dimensional Outlines (Cont'd)

Dual-In-Line Plastic and Frit-Seal Ceramic Packages (Cont'd)

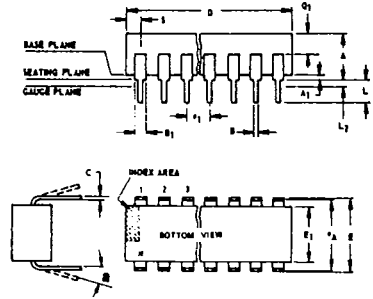

**NOTES:**  
 Refer to Rules for Dimensioning (JEDEC Publication No. 95) for Axial Lead Product Outlines.  
 1. When this device is supplied solder dipped, the maximum lead thickness (narrow portion) will not exceed 0.013" (0.33 mm).  
 2. Leads within 0.005" (0.12 mm) radius of True Position (TP) at gauge plane with maximum material condition and unit installed.  
 3. eA applies in zone L2 when unit installed.  
 4. alpha applies to spread leads prior to installation.  
 5. N is the maximum quantity of lead positions.  
 6. N1 is the quantity of allowable missing leads.

(E) and (F) SUFFIXES (JEDEC MO-001-AB)  
 14-Lead Dual-In-Line Plastic or Frit-Seal Ceramic Package

SYMBOL	INCHES		NOTE	MILLIMETERS	
	MIN.	MAX.		MIN.	MAX.
A	0.155	0.200		3.94	5.08
A <sub>1</sub>	0.020	0.050		0.51	1.27
B	0.014	0.020		0.356	0.508
B <sub>1</sub>	0.050	0.065		1.27	1.65
C	0.008	0.012	1	0.204	0.304
D	0.745	0.770		18.93	19.55
E	0.300	0.325		7.62	8.25
E <sub>1</sub>	0.240	0.260		6.10	6.60
e <sub>1</sub>	0.100 TP		2	2.54 TP	
e <sub>A</sub>	0.300 TP		2, 3	7.62 TP	
L	0.125	0.150		3.18	3.81
L <sub>2</sub>	0.000	0.030		0.000	0.76
alpha	0°	15°	4	0°	15°
N	14		5	14	
N <sub>1</sub>	0		6	0	
Q <sub>1</sub>	0.040	0.075		1.02	1.90
S	0.065	0.090		1.66	2.28

92SS-4296R3

(E) and (F) SUFFIXES (JEDEC MO-001-AC)  
 16-Lead Dual-In-Line Plastic or Frit-Seal Ceramic Package

SYMBOL	INCHES		NOTE	MILLIMETERS	
	MIN.	MAX.		MIN.	MAX.
A	0.155	0.200		3.94	5.08
A <sub>1</sub>	0.020	0.050		0.51	1.27
B	0.014	0.020		0.356	0.508
B <sub>1</sub>	0.035	0.065		0.89	1.65
C	0.008	0.012	1	0.204	0.304
D	0.745	0.785		18.93	19.93
E	0.300	0.325		7.62	8.25
E <sub>1</sub>	0.240	0.260		6.10	6.60
e <sub>1</sub>	0.100 TP		2	2.54 TP	
e <sub>A</sub>	0.300 TP		2, 3	7.62 TP	
L	0.125	0.150		3.18	3.81
L <sub>2</sub>	0.000	0.030		0.000	0.76
alpha	0°	15°	4	0°	15°
N	16		5	16	
N <sub>1</sub>	0		6	0	
Q <sub>1</sub>	0.040	0.075		1.02	1.90
S	0.015	0.060		0.39	1.52

92CM-15967R4

(E) SUFFIX  
 18-Lead Dual-In-Line Plastic Package

SYMBOL	INCHES		NOTE	MILLIMETERS	
	MIN.	MAX.		MIN.	MAX.
A	0.155	0.200		3.94	5.08
A <sub>1</sub>	0.020	0.050		0.508	1.27
B	0.014	0.020		0.356	0.508
B <sub>1</sub>	0.035	0.065		0.89	1.65
C	0.008	0.012	1	0.204	0.304
D	0.845	0.885		21.47	22.47
E <sub>1</sub>	0.240	0.260		6.10	6.60
e <sub>1</sub>	0.100 TP		2	2.54 TP	
e <sub>A</sub>	0.300 TP		2, 3	7.62 TP	
L	0.125	0.150		3.18	3.81
L <sub>2</sub>	0	0.030		0	0.762
alpha	0°	15°	4	0°	15°
N	18		5	18	
N <sub>1</sub>	0		6	0	
S	0.015	0.060		0.39	1.52

92CS-30630

(E) SUFFIX  
 22-Lead Dual-In-Line Plastic Package

SYMBOL	INCHES		NOTE	MILLIMETERS	
	MIN.	MAX.		MIN.	MAX.
A	0.155	0.200		3.94	5.08
A <sub>1</sub>	0.020	0.050		0.508	1.27
B	0.015	0.020		0.381	0.508
B <sub>1</sub>	0.035	0.065		0.89	1.65
C	0.008	0.012	1	0.204	0.304
D		1.120			28.44
E	0.390	0.420		9.91	10.66
E <sub>1</sub>	0.345	0.355		8.77	9.01
e <sub>1</sub>	0.100 TP		2	2.54 TP	
e <sub>A</sub>	0.400 TP		2, 3	10.16 TP	
L	0.125	0.150		3.18	3.81
L <sub>2</sub>	0	0.030		0	0.762
alpha	2°	15°	4	2°	15°
N	22		5	22	
N <sub>1</sub>	0		6	0	
Q <sub>1</sub>	0.055	0.085		1.40	2.15
S	0.015	0.060		0.381	1.27

92CS-30830

(F) SUFFIX (JEDEC MO-001-AG)  
 16-Lead Dual-In-Line Frit-Seal Ceramic Package

SYMBOL	INCHES		NOTE	MILLIMETERS	
	MIN.	MAX.		MIN.	MAX.
A	0.165	0.210		4.20	5.33
A <sub>1</sub>	0.015	0.045		0.381	1.14
B	0.015	0.020		0.381	0.508
B <sub>1</sub>	0.045	0.070		1.15	1.77
C	0.009	0.011	1	0.229	0.279
D	0.750	0.795		19.05	20.19
E	0.295	0.325		7.50	8.25
E <sub>1</sub>	0.245	0.300		6.23	7.62
e <sub>1</sub>	0.100 TP		2	2.54 TP	
e <sub>A</sub>	0.300 TP		2, 3	7.62 TP	
L	0.120	0.160		3.05	4.06
L <sub>2</sub>	0.000	0.030		0.000	0.76
alpha	2°	15°	4	2°	15°
N	16		5	16	
N <sub>1</sub>	0		6	0	
Q <sub>1</sub>	0.050	0.080		1.27	2.03
S	0.010	0.060		0.254	1.52

92CM-22284R1

(E) and (F) SUFFIXES (JEDEC MO-015-AA)  
 24-Lead Dual-In-Line Plastic or Frit-Seal Ceramic Package

SYMBOL	INCHES		NOTE	MILLIMETERS	
	MIN.	MAX.		MIN.	MAX.
A	0.120	0.250		3.10	6.30
A <sub>1</sub>	0.020	0.070		0.51	1.77
B	0.016	0.020		0.407	0.508
B <sub>1</sub>	0.028	0.070		0.72	1.77
C	0.008	0.012	1	0.204	0.304
D	1.20	1.29		30.48	32.76
E	0.600	0.625		15.24	15.87
E <sub>1</sub>	0.515	0.580		13.09	14.73
e <sub>1</sub>	0.100 TP		2	2.54 TP	
e <sub>A</sub>	0.600 TP		2, 3	15.24 TP	
L	0.100	0.200		2.54	5.00
L <sub>2</sub>	0.000	0.030		0.00	0.76
alpha	0°	15°	4	0°	15°
N	24		5	24	
N <sub>1</sub>	0		6	0	
Q <sub>1</sub>	0.040	0.075		1.02	1.90
S	0.040	0.100		1.02	2.54

92CS26938R2

(E) SUFFIX  
 40-Lead Dual-In-Line Plastic Package

SYMBOL	INCHES		NOTE	MILLIMETERS	
	MIN.	MAX.		MIN.	MAX.
A	0.120	0.250		3.10	6.30
A <sub>1</sub>	0.020	0.070		0.51	1.77
B	0.016	0.020		0.407	0.508
B <sub>1</sub>	0.028	0.070		0.72	1.77
C	0.008	0.012	1	0.204	0.304
D	2.000	2.090		50.80	53.09
E <sub>1</sub>	0.515	0.580		13.09	14.73
e <sub>1</sub>	0.100 TP		2	2.54 TP	
e <sub>A</sub>	0.600 TP		2, 3	15.24 TP	
L	0.100	0.200		2.54	5.00
L <sub>2</sub>	0.000	0.030		0.00	0.76
alpha	0°	15°	4	0°	15°
N	40		5	40	
N <sub>1</sub>	0		6	0	
Q <sub>1</sub>	0.065	0.095		1.66	2.41
S	0.040	0.100		1.02	2.54

92CS-30959

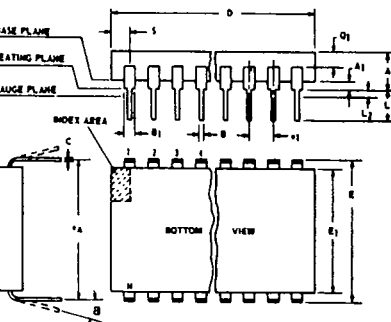

**NOTES:**  
 Refer to Rules for Dimensioning (JEDEC Publication No. 95) for Axial Lead Product Outlines.  
 1. When this device is supplied solder dipped, the maximum lead thickness (narrow portion) will not exceed 0.013".  
 2. Leads within 0.005" (0.12 mm) radius of True Position (TP) at gauge plane with maximum material condition and unit installed.  
 3. eA applies in zone L2 when unit installed.  
 4. alpha applies to spread leads prior to installation.  
 5. N is the maximum quantity of lead positions.  
 6. N1 is the quantity of allowable missing leads.

T-90-20

Dimensional Outlines (Cont'd)

Ceramic Flat Packs

(K) SUFFIX (JEDEC MO-004-AF)  
14-Lead

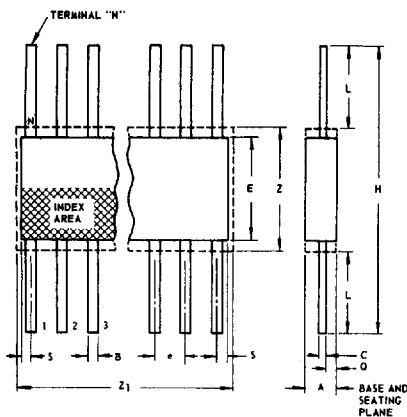

SYMBOL	INCHES		NOTE	MILLIMETERS	
	MIN.	MAX.		MIN.	MAX.
A	0.008	0.100		0.21	2.54
B	0.015	0.019	1	0.381	0.482
C	0.003	0.006	1	0.077	0.152
e	0.050 TP		2	1.27 TP	
E	0.200	0.300		5.1	7.6
H	0.600	1.000		15.3	25.4
L	0.150	0.350		3.9	8.8
N	14		3	14	
Q	0.005	0.050		0.13	1.27
S	0.000	0.050		0.00	1.27
Z	0.300		4	7.62	
Z <sub>1</sub>	0.400		4	10.16	

92SS-4300R3

NOTES:

1. Refer to JEDEC Publication No. 95 for Rules for Dimensioning Peripheral Lead Outlines.
2. Leads within 0.005" (0.12 mm) radius of True Position (TP) at maximum material condition.
3. N is the maximum quantity of lead positions.
4. Z and Z<sub>1</sub> determine a zone within which all body and lead irregularities lie.

(K) SUFFIX (JEDEC MO-004-AG)  
16-Lead

SYMBOL	INCHES		NOTE	MILLIMETERS	
	MIN.	MAX.		MIN.	MAX.
A	0.008	0.100		0.21	2.54
B	0.015	0.019	1	0.381	0.482
C	0.003	0.006	1	0.077	0.152
e	0.050 TP		2	1.27 TP	
E	0.200	0.300		5.1	7.6
H	0.600	1.000		15.3	25.4
L	0.150	0.350		3.9	8.8
N	16		3	16	
Q	0.005	0.050		0.13	1.27
S	0.000	0.025		0.00	0.63
Z	0.300		4	7.62	
Z <sub>1</sub>	0.400		4	10.16	

92CS-17271R3

(K) SUFFIX  
24-Lead

SYMBOL	INCHES		NOTE	MILLIMETERS	
	MIN.	MAX.		MIN.	MAX.
A	0.075	0.120		1.91	3.04
B	0.018	0.022	1	0.458	0.558
C	0.004	0.007	1	0.102	0.177
e	0.050 TP		2	1.27 TP	
E	0.600	0.700		15.24	17.78
H	1.150	1.350		29.21	34.29
L	0.225	0.325		5.72	8.25
N	24		3	24	
Q	0.035	0.070		0.89	1.77
S	0.060	0.110	1	1.53	2.79
Z	0.700		4	17.78	
Z <sub>1</sub>	0.750		4	19.05	

92CS-19949R2

(K) SUFFIX  
28-Lead

SYMBOL	INCHES		NOTE	MILLIMETERS	
	MIN.	MAX.		MIN.	MAX.
A	0.075	0.120		1.91	3.04
B	0.018	0.022	1	0.458	0.558
C	0.004	0.007	1	0.102	0.177
e	0.050 TP		2	1.27 TP	
E	0.600	0.700		15.24	17.78
H	1.150	1.350		29.21	34.29
L	0.225	0.325		5.72	8.25
N	28		3	28	
Q	0.035	0.070		0.89	1.77
S	0	0.060	1	0	1.53
Z	0.700		4	17.78	
Z <sub>1</sub>	0.750		4	19.05	

92CS-20972